



## Yamaha's new models stir up great interest and excitement

The 66th Paris Motor Show (66<sup>e</sup> Salon du Cycle et du Motorcycle), which is one of the most popular and prestigious events of its kind in the world, took place at Versailles for a 10-day period from Sept. 28 to Oct. 7.

Yamaha Motor unveiled part of the sparkling '80 lineup including the water-cooled 2-stroke twin RD350 and 4-stroke single XT-250. Both were the amazing



as the GP-winning production racer TZ350. Race-bred technical refinements including the water-cooling system was of strong appeal to young, active motorcyclists. The latter also featured many of Yamaha's technical improvements realized through many years of world GP motocross experience. The Monocross rear suspension system adds extra performance and dependability to this unique 4-stroke single dual-purpose model. (Details will be introduced in our forthcoming



maximum pleasure and utility of motorcycle riding for sport, street or family leisure purpose.

### Race-bred new models

Spectators' interest was naturally focussed on the new water-cooled 2-stroke twin RD350 and Monocross-fitted XT250. The former adopted basically the same design



stars of the show and stirred up great interest and excitement among a large number of European motorcycle enthusiasts drawn to the Yamaha corner.

**From France:** The Yamaha corner was arranged by Ets. Sonauto S.A. showing the exciting '80 motorcycle range. The display of Yamaha models was expressly attractive and impressive, emphasizing the



issue.)  
Mr. N. Wagner, President of Sonauto, says as follows:  
"The sales war will get hotter in the '80's. To win it, we have to get a grasp on market trends, above all things, so that we can supply what customers demand. Our corner enjoyed such an immense response from the buying public, and this reflects the success of Yamaha's commodity plan".

## Around the World

# To Break Through 50% Share Line

## Extensive PR by Norkis for sales expansion

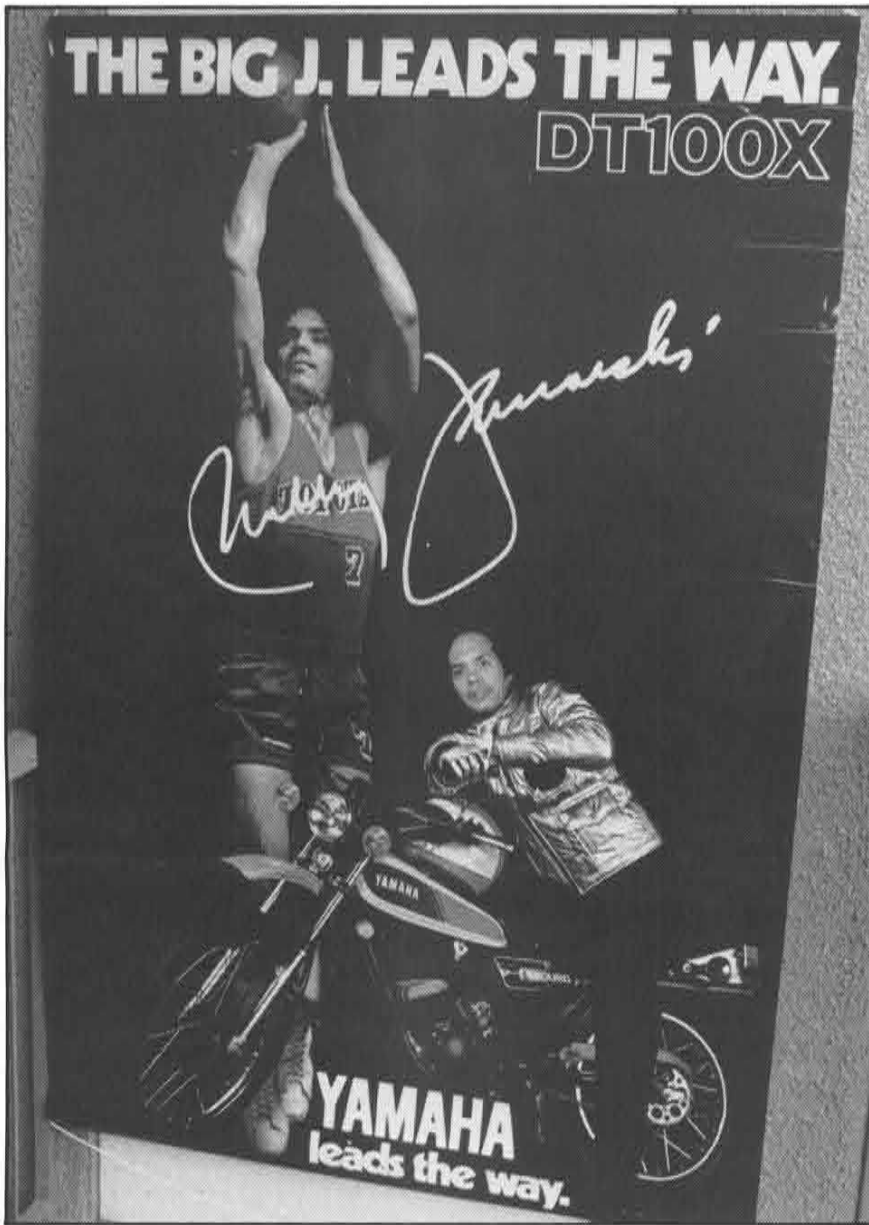

A very attractive hanging banner (1200 x 1800mm, multicolored)

**From the Philippines:** Robert Joe Worski — everyone knows his name in the Philippines. Or rather, "Big J" is more familiar than his real name. Being considered as the greatest talent in Philippine professional basketball, his every action furiously excites his fans and his gallant appearances on the screen intoxicate audiences. They say that not a single day passes without "Big J" becoming a topic of conversation. He is almost a national hero now.

With the cooperation of this hero, a strong PR campaign for Yamaha is being carried out by Norkis Trading Co., Inc. at present. Their catchphrase "Yamaha leads the way" aligns with against the main phrase "The Big J leads the way," and together suggest that a real sportsman loves motorcycles and motor-sports.

Through this campaign, photos are used as powerful tools for promotion. One on the left features "Big J" just making a jump shot in combination with a dandy "Big J" in a fashionable motorcycle suit riding a DT 100X, trying to establish

the image of the bike as a private-use vehicle. This picture was designed for a 1200 x 1800 mm hanging banner. The other on the right was taken for a 365 x 515 mm giveaway pin-up poster, featuring "Big J" dripping with sweat while dribbling, combined with wild "Big J" still muddy after some off-road riding. The back of this poster features "Big J" 's basketball techniques as well as proper riding techniques for bikes. Both pictures are printed with multi colors and have "Big J" 's autograph. The posters are so popular that the young people almost scramble for them. This PR campaign as a whole has received much publicity from the press as well.

In the Philippines, as has been introduced in this column several times in the past, bikes usually have sidecars attached to them which people use as short distance taxi cabs. Norkis, however, in concert with the government's save energy policy, is appealing the use of bike as private vehicles even to the car owners. The real intention of the PR campaign this time lies in the

promotion of bikes for personal use.

The oil crisis has triggered the soaring of commodity prices in every part of the world and the Philippines is no exception. But Yamaha's share from January to

April this year reached 48.8% exceeding last year's figure of 42.5%. That is why Norkis is expecting much out of this PR campaign for further increasing their market share.

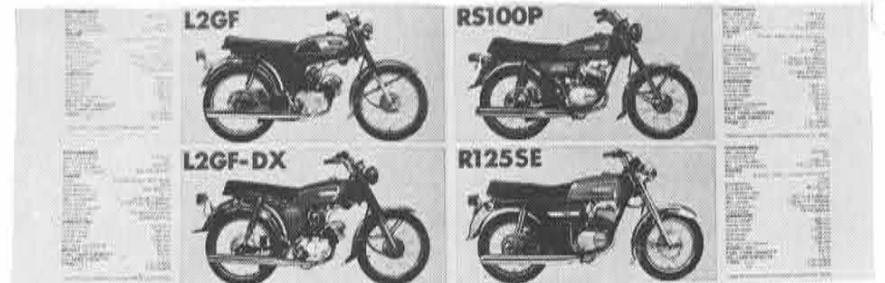
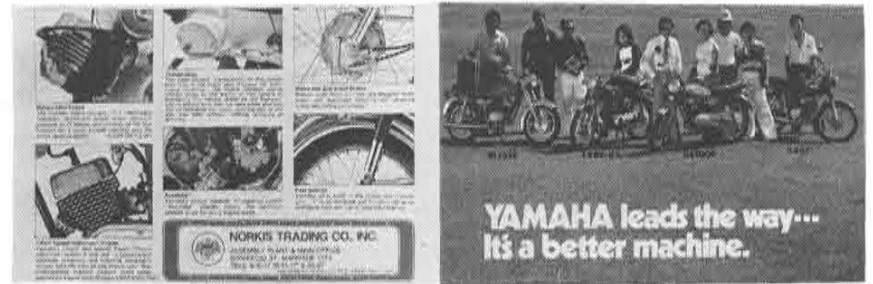

One leaflet explains the outline of the DT100X while the other introduces the lineup. (215 x 240 mm each, multicolored) In addition, a giant-size multicolored lineup poster is also prepared.

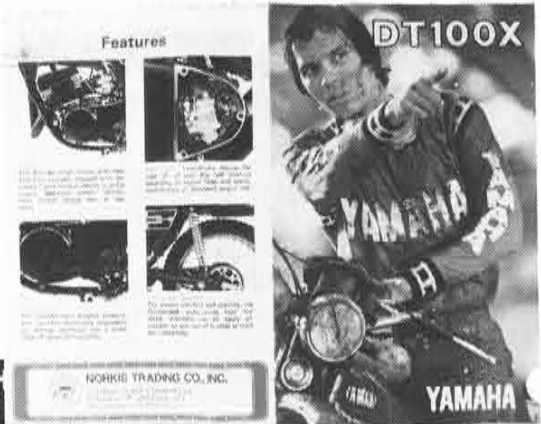

## Spread of genuine parts

Norkis Trading Co., Inc. is directing greater efforts toward the spread of genuine parts along the above campaign in close cooperation with all affiliated dealers.

The spread of genuine parts is aimed to do away with the imitation parts of poor quality. This will prevent every customer from buying cheap and wasting his money.

Norkis' continued efforts will enhance the reputation of Yamaha brand and bring on another increase in sales.

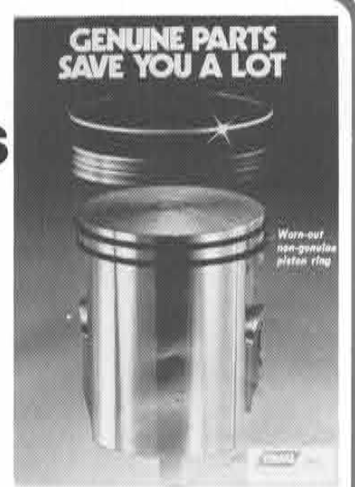

# THE BIG J. LEADS THE WAY.

**YAMAHA**  
leads the way.

A giveaway article for distribution during the campaign (364 x 515 mm, multicolored)

## BIG J'S BASKETBALL TECHNIQUE

## BIG J'S RIDING TECHNIQUE

**YAMAHA leads the way... It's a better machine.**

"Big J's" basketball techniques and riding techniques are explained on the reverse side.

# Big service campaign is planned

From Colombia: Impormoto, S. A., Yamaha importer in Colombia has laid plans to launch a large-scale Yamaha campaign around all major cities, in order to enhance the brand image of Yamaha.

Planned activities are: 1. free check service, 2. sale of replacement parts, 3. organization of the Yamaha Motocross School for novice motorcyclists and 4. motorcycle exhibition. In order to make this campaign more attractive and successful, the company will engage the services of top-ranking entertainers. Their music and dancing show, together with delightful movies, will entertain the public to their hearts' content.

The main aim of this campaign is to set a springboard for another leap forward by enhancing the brand image of Yamaha and winning customers' trust.

Yamaha products share of the market is now around 40% and should become larger with the success of the forthcoming campaign.

"Quality products will never fail to find a good market", says Mr. Francisco Jose Sierra, General Manager and one of the campaign planners, "In order to win a sales war for the eighties, even greater efforts must



Mr. Francisco Jose Sierra speaks of his ambitious plan for the eighties.

be put into the sale of these products. Our planned campaign will make the general public renew their recognition of high quality Yamaha products".

The campaign is scheduled to start early in 1980, and will last for 6 weeks through the six largest cities, namely, Medellin, Cari, Pereira, Armenia, Bogota and Bucaromanea.

All affiliated dealers will give full support to this campaign.

Jacky Ickx, the famous Belgian driver of Martini Porsche and Le Mans 24-hour race winner is pictured at Zolder scene of the 1979 Belgian Formula 1 Grand Prix sitting astride the exclusive Yamaha Martini 1.1 as introduced in

our No. 7-8 issue. 500 units only of this sensational grand touring model decorated in the prestigious Martini racing colours were produced for the European market.

## Jacky Ickx and Yamaha Martini 1.1

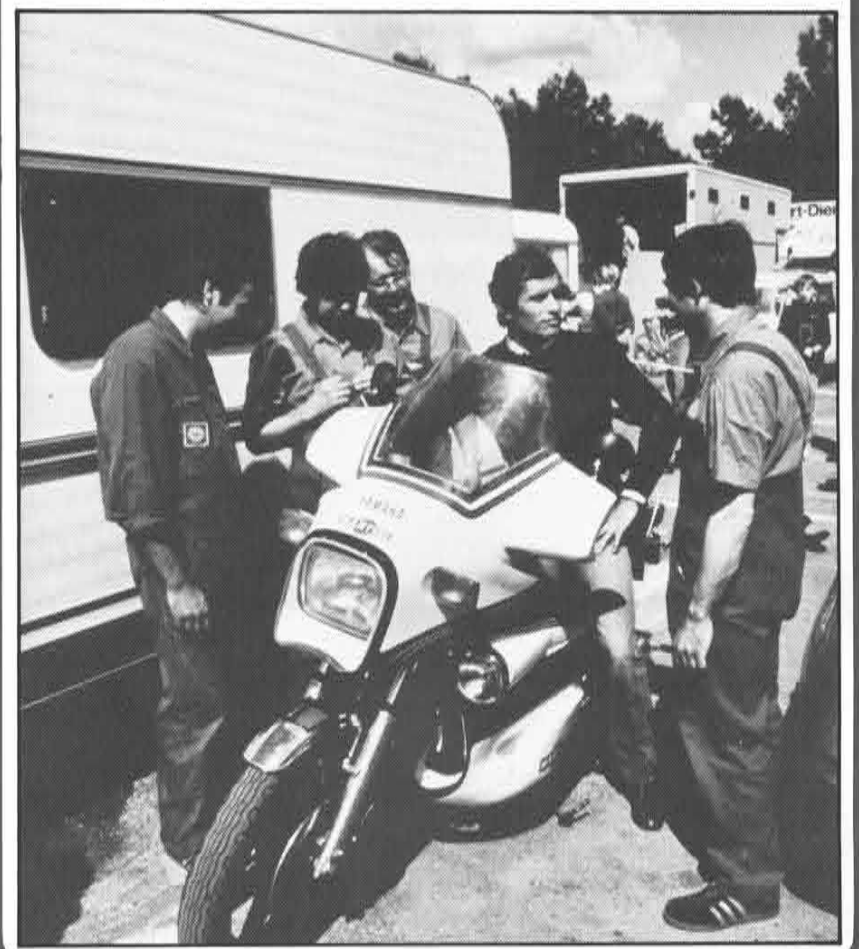

## Around the World

# Oil shortage is giving rise to a new bike boom

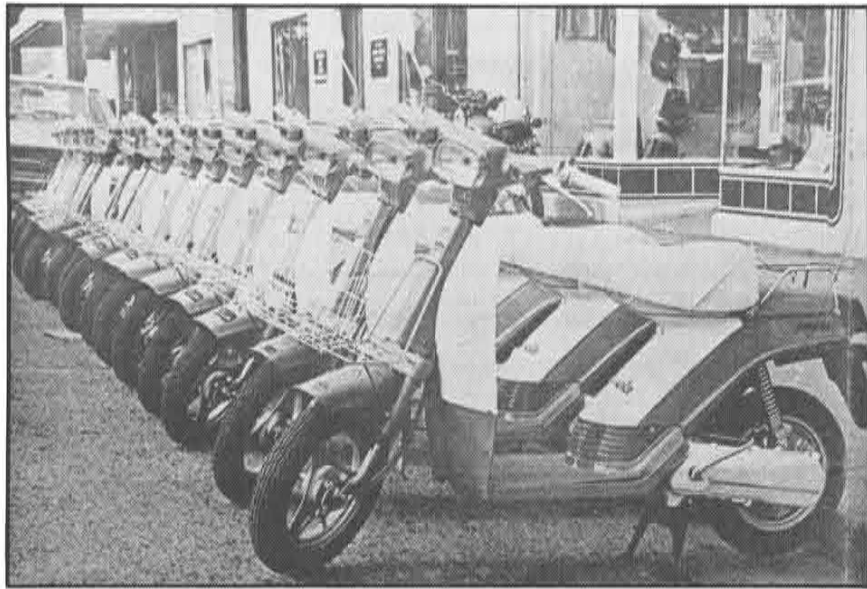

**From New Zealand:** Oil shortage is creating a new bike boom in a number of nations across the world. Introduced here is a good example of this trend.

The current energy situation in New Zealand with petrol stations closed over the weekend, carless days and the high cost of petrol is clearly giving rise to a boom for the motorcycle industry. Areas which previously did not sell commuter bikes are now getting a strong increase in

orders.

More and more people are finding these bikes to be a more economical means of transportation than their gas-guzzling cars.

Cycle World Yamaha, one of Moller Yamaha's dealers, is located in a rural town, where it was formerly impossible to sell 50cc bikes, and has recently circularised every household in the town and is now making good sales of the Yamaha Passola.



Mr. Yen To Chuang, Chairman (left) and Mr. Hisao Koike, President of Yamaha Motor cutting the tape at the opening ceremony.



# Production of Yamaha

# cycles is resulting from technical cooperation with Wan San

**From Taiwan:** The Government of Taiwan has officially approved a new technical cooperation between Yamaha Motor (Mr. Hisao Koike, President) and Wan San Machinery Manufacturing (Mr. Yen To Chuang, Chairman). This will ensure Yamaha new start in Taiwan.

On Sept. 11 Wan San Machinery Manufacturing announced the above approval and held an opening ceremony for its newly constructed Tacha plant (Mr. Lin, Plant manager) with a large attendance of government officials, press personnel and other persons concerned.

The Tacha plant which is located at Tacha Tchen, Taichung, covers 7,300 m<sup>2</sup> in total site area and 3,240 m<sup>2</sup> in total building area. Monthly production will be maintained at 3,000 units for the time being. The company has already laid plans to expand production facilities in the future.

Representing Yamaha Motor, Mr. and Mrs. Koike attended the opening ceremony, together with Mr. T.

Kaga, General Manager of the Production Planning Division, Mr. Y. Sato, General Manager of the Overseas Marketing Operations and the responsible staff of production and marketing operations.

Mrs. Koike pushed the starter button of the conveyor line and the memorable first production bike was slowly rolled off the line by Mr. Lin, Plant Manager. This was followed by thunders of applause from a large attendance of people.

Mr. Koike, President of Yamaha Motor and Mr. Kuo Sui Ho, Managing Director shared their joy, together pouring champagne on the new RX125 bike in celebration of the bright future.

After the opening ceremony Mr. Koike attended a press interview and announced the following message, thanking government authorities and all parties concerned for their cooperation and understanding:

"We at Yamaha Motor are to celebrate the 25th anniversary of the



## YAMAHA NEWS

### Contributions wanted

This issue also contains 16 pages thanks to your fine cooperation. We at the Editorial Room of Yamaha News are always looking forward to having you supply us with various editorial materials so that we can make Yamaha News more instrumental to your business. Any sort of news or information would be highly appreciated, if it is about Yamaha. Newspaper or magazine clippings will also serve to help us. Please attach some photos, colored or black white to your news or information wherever possible.

**Address: Editorial Room of Yamaha News  
Advertising & Public Relations  
Overseas Markets  
Yamaha Motor Co., Ltd.  
2500 Shingai, Iwata-shi, Shizuoka-ken  
(Japan)**

Tel: IWATA 05383-2-1111  
Telex: IWATA 4263 751 YAMAHA J  
Cable: YAMAHAMOTOR IWATA

### Asking for your cooperation

The staff of the Planning & Coordinating Overseas Operations are also asking for your cooperation.

Any sort of news or information about motor sports or safe riding promotion in your country is eagerly wanted by them, whether or not it is concerned with Yamaha. Newspaper or magazine clippings will also be helpful.

Please mail your news or information to the following address:

**Planning & Coordinating  
Overseas Operations  
Yamaha Motor Company, Ltd.**



Mrs. Koike pushes the starter button of the conveyor line.



The memorable first RX125 bike is rolling off the line. Mr. Kuo Sui Ho, Managing Director and Mr. Koike are ready to pour champagne on the bike.

# tion of motor- med in Taiwan al cooperation n Machinery



A street of Taipei. Motorcycles are a good means of transportation for people. New Yamaha bikes are expected to win popularity.

founding of our company next year. For the past years we have made it our consistent business policy to develop original products of high quality and high performance, including motorcycles, motorboats, sailboats, fishing boats, outboard motors, marine diesel engines, snowmobiles, portable generators, karts, etc. These products are finding a very good market across the world.

Our business activity is not limited to the supply of these products. We are always positive enough to cooperate with overseas manufacturers concerned with local production of the above products.

We wish to make contributions to the economic growth or improvement of production technology of each partner nation through offering every possible technical aid and know-how.

Our technical cooperation with Wan Sun Machinery has been realized in accordance with the abovementioned policy. This cooperation will not

only offer quality products for the people of Taiwan but also make contributions to the technical improvement of the motorcycle and its related industries, through which the economic growth of the nation will be accelerated. You are cordially requested to make every possible use of our technical cooperation".

At present about 3 million bikes are registered in Taiwan which has a population of 17 million people. This means one bike for every 5.6 persons. The market is now picking up and about 750,000 new bikes will be marketed this year.

Yamaha's new start will set spurs once again to this upward tendency.

This news has already been made known to all concerned with the industry and dealers are waiting for the supply of high quality, high performance Yamaha bikes.

## Welcome to Yamaha

### I WISH TO DO A LOT FOR A LOT OF PEOPLE IN MANY DIFFERENT NATIONS

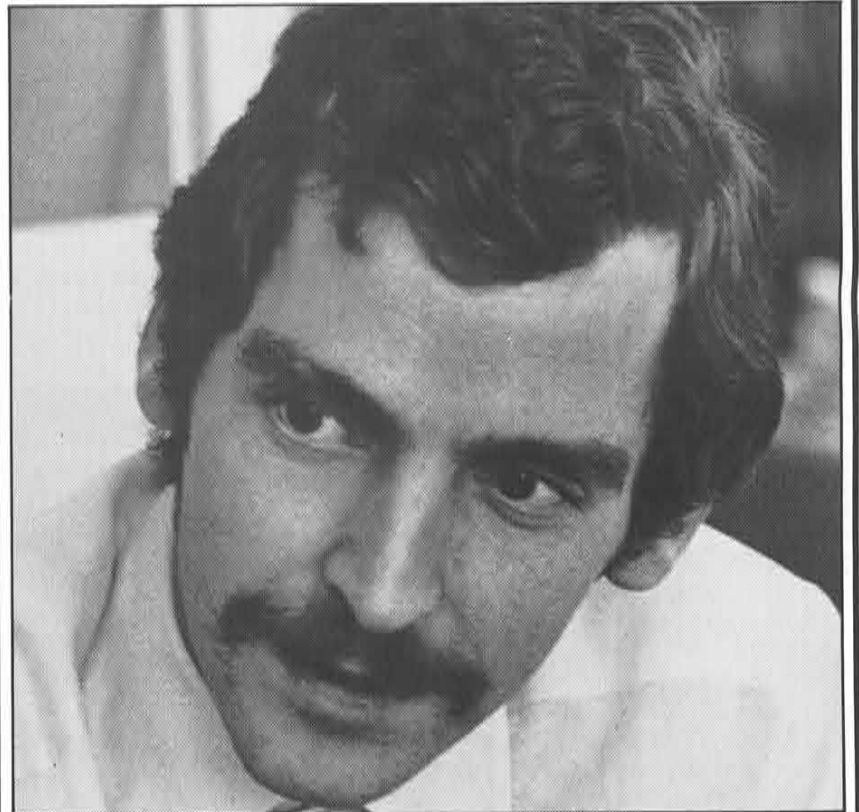

#### New PR Manager, Yamaha Motor N.V. Mr. Tom van Breen

Mr. Tom van Breen, a 30 year old Dutch gentleman interested in collecting various antiques, has filled the position of PR Manager, Yamaha Motor N.V. vacated by Mr. Rodney Gould who has opened a new motorcycle shop in England.

He was born in Epe, in the eastern part of Holland in December 31, 1948. His college major was a course in marketing and public relations in the United States, after which he obtained a position with Yamaha Motor N.V. in December 1974. As a typical international businessman he has a good command of French, German and Swedish, as well as English. When he paid his first visit to Yamaha Motor at Iwata, he expressed his wishes as follows: "I would like to master as many languages as possible as I have to contact many people of different nationalities. To be a good linguist will lead to better business, I believe" says Mr. Breen, "As you know, Europe is one of the most important markets

and the sales war will become inevitably hotter in the future. I have much to do as new PR Manager.

In the first place we have to know more about the particular needs of each national market so that every sales promotion plan can be brushed up to work successfully. Also, specific efforts must be directed towards educating our dealers along the lines of our established market policy at a time when safe riding is becoming a matter of keener public concern and oil shortage threatens to make the situation much more complex in many nations".

Mr. Breen speaks gently but with ardor about his important business. He is not married yet and business seems to be everything for him! Yamaha Motor N.V. is publishing a quarterly journal named "Circuit" and Mr. Breen promised to supply us with various news and information and we are wishing him every success in his future activity.

# World-wide sports news

World  
championship  
Formula 750

# PATRICK PONS, A NEW CHAMPION!



Riding a Sonauto-entered Yamaha machine Patrick Pons (France) nearly clinched his first world championship title when he won both legs of the West German round held at Hockenheim on September 23. The race turned into a battle of tires. During both legs Johnny Cecotto and Michel Frutschi had to make lengthy pit stops to change rear slick tires after they had worn down to the canvas. On the other hand, Pons rode on the much more successful Dunlop

covers and his spectacular performance at Hockenheim made up for a disastrous previous round at Assen. Pons' main challenge came from his team-mate Christian Sarron, recovering well from a knee injury. Pons finished first in both races and came within one point of his first world championship title. He concluded the '79 F750 title battle by taking two 3rd spots in the Yugo round on Sept. 30.

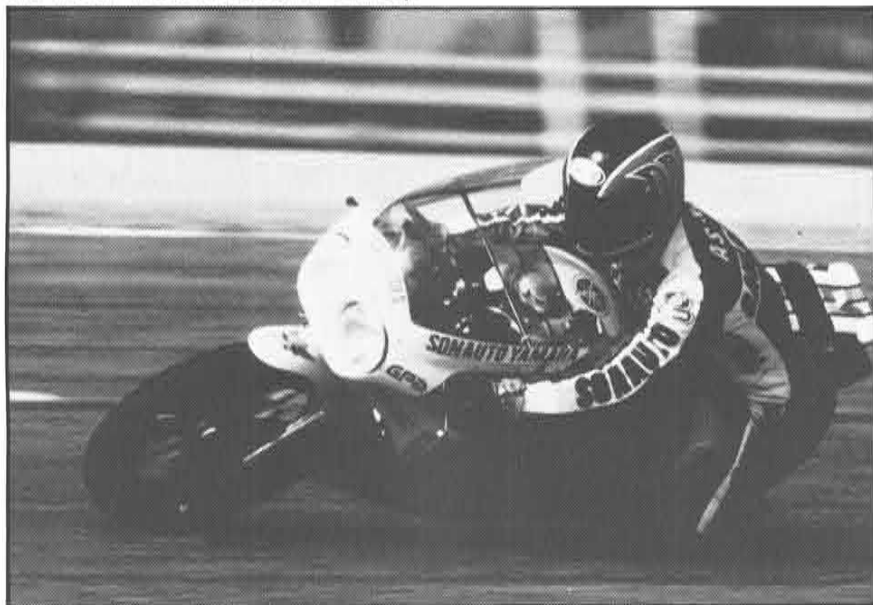

Asami is chasing the Honda.

The Sonauto-entered Yamaha 750 team consisting of Patrick Pons (France) and Sadao Asami (Japan) highlighted the 43rd Bol d'Or 24-hour race, one of the most prestigious endurance events in the world. The Yamaha pair shot to the front from the start and retained the lead throughout the early stages of this long distance event. Asami crashed just before midnight after he had had a new front tire fitted to the machine and lost time dropped the team off the leaderboard completely. But their recovery was truly dramatic. Three hours after the crash they had worked themselves into 5th spot.

## More drama!

The Bol d'Or-favorite Honda pair (Christian Leon and Jean Claude



## RESULTS

### World Championship Formula 750

#### Round 5 Austria July 22

##### First race

1. W. Nennung ..... Yamaha
2. J. Cornu ..... Yamaha
3. P. Pons ..... Yamaha
4. H. Rigal ..... Yamaha
5. B. Schulze ..... Yamaha

##### Second race

1. W. Nennung ..... Yamaha
2. P. Pons ..... Yamaha

3. G. Johnson ..... Yamaha
4. H. Rigal ..... Yamaha
5. F. Kerschauer ..... Yamaha

#### Round 6 Canada July 29

##### First race

1. P. Pons ..... Yamaha
2. S. Gervais ..... Yamaha
3. F. Mctaggart ..... Yamaha
4. R. Roche ..... Yamaha
5. M. Frutschi ..... Yamaha

##### Second race

1. M. Frutschi ..... Yamaha
2. P. Pons ..... Yamaha
3. S. Gervais ..... Yamaha

# Thrill at the

## Sept. 15 & 16 France

Chemarin, both Frenchmen) showed their experience during the night. It looked as if they were going to have a trouble-free run to the flag. Then Chemarin crashed heavily! This gave a better chance to the chasing teams. Pons and Asami made every effort to make up for the difference. At one stage Asami was gaining nearly a minute an hour on the Honda. What a threat to the Honda!

But the Yamaha team's chance of victory went when a chain tensioner broke in the final hour. The Yamaha team eventually finished second by covering 616 laps (93.58 mph) against the Honda's 620 laps (94.10 mph).

No. of starters: 70  
No. of finishers: 32  
Race distance: 2,251.3 miles



The Sonauto Yamaha T2750 is fitted with a kick starter.

◀ One of the Sonauto staff measuring a lap time.

- 4. M. Fontan ..... Yamaha
  - 5. D. Sorenson ..... Yamaha
- Round 7 USA Aug. 5**  
**First race**  
 1. K. Roberts ..... Yamaha  
 2. G. Romero ..... Yamaha  
 3. D. Aldana ..... Yamaha  
 4. R. Mamola ..... Yamaha  
 5. P. Pons ..... Yamaha

- Second race**  
 1. K. Roberts ..... Yamaha  
 2. G. Romero ..... Yamaha  
 3. M. Frutschi ..... Yamaha  
 4. R. Schiachter ..... Yamaha  
 5. D. Aldana ..... Yamaha

- Round 8 Holland Sept. 9**  
**First race**  
 1. V. Dulmen ..... Yamaha  
 2. G. Bonera ..... Yamaha  
 3. M. Frutschi ..... Yamaha  
 4. C. Huguet ..... Yamaha  
 5. R. Roche ..... Yamaha

- Second race**  
 1. J. Cecotto ..... Yamaha  
 2. V. Dulmen ..... Yamaha  
 3. W. Hartog ..... Yamaha  
 4. M. Frutschi ..... Yamaha  
 5. G. Bonera ..... Yamaha

- Rond 9 West Germany Sept. 23**  
**First race**  
 1. P. Pons ..... Yamaha  
 2. C. Sarron ..... Yamaha  
 3. S. Asami ..... Yamaha  
 4. H. Rigal ..... Yamaha  
 5. M. Fontan ..... Yamaha

- Second race**  
 1. P. Pons ..... Yamaha  
 2. M. Fontan ..... Yamaha  
 3. C. Sarron ..... Yamaha  
 4. H. Rigal ..... Yamaha  
 5. R. Roche ..... Yamaha

**Final Championship Positions**

1. P. Pons	Yamaha	154 pts.
2. M. Frutschi	Yamaha	132 pts.
3. J. Cecotto	Yamaha	126 pts.
4. S. Asami	Yamaha	73 pts.
5. G. Bonera	Yamaha	70 pts.

# Yamaha riders win both main races

———— '79 Japanese GP ————



Kanaya is pulling away from the others.

Yamaha's veteran rider Hideo Kanaya displayed his ability by winning the international 750/350 race (17 laps) of the '79 Japanese Grand Prix organized at Suzuka on Sept. 9.

Riding a powerful YZR750 Kanaya hit the fastest practice time and took the pole position. Keiji Kinoshita on a Yamaha TZ350 made the clearest start followed by Kanaya and Hiroyuki Kawasaki

(Suzuki RGB500). The Yamaha ace snatched the lead during the second lap and went on to consolidate it lap by lap.

No serious challenge came from the others and Kanaya won this race with ease, setting the absolute lap time record at 2'14"05. Yamaha dominated the main race of the Japanese GP for the 7th consecutive year.

The 15-lap 125cc race was also ex-

citing. Yamaha's new weapon the TZ125 demonstrated its fantastic performance on the home circuit. Tadashi Ezaki on his TZ125 led the race from the start to the finish.

The Suzuka-favorite Honda team launched a tough challenge but no Honda MT125R machine was a match for Ezaki's Yamaha.



Ezaki is showing his top form.



Indonesian star Budiyanto Tajudin rides another TZ125 and takes 7th spot.

# 43rd Bol d'Or



Pons thrills his home fans.



## Jorge Bardales dominates the Guatemalan motocross

Motocross enthusiasm is still growing in Guatemala, South America with motorcycle importers' active support at the roots.

Canella y Cia. Ltda., Yamaha's general importer, enters a powerful team in each big event. The best member of the Canella team is Jorge Bardales who has been unbeaten in the 100cc class since 1975.

In particular, he scored one of his most spectacular wins in the 7th international classic event held

recently at the finca Florencia de Antigua Guatemala. Bardales outclassed all rivals in both heats of the 100cc race.

The Canella-entered Yamaha performed well all the way and no other machine was a match for it.

Bardales took a checkered flag in each heat amid thunders of applause from a crowd of spectators. By this win he dominated the 100cc class for the fifth consecutive year, thus enhancing the reputation of Yamaha products.







# YAMAHA V80 (Y80)



# ► For your better sales business ◀

The transistor controlled ignitor, like the C.D.I. introduced in our last issue, is virtually maintenance-free unless the engine itself is disassembled. This unique ignition system used on our 4-stroke street models is gaining popularity among a large number of customers. Introduced here are the characteristics and functional mechanism of this system.

## Positive spark and correct ignition timing

The ignition system in general must produce a positive spark at the correct time to ignite the mixture. Otherwise, the engine could not work well. So far as the above requirements are concerned, the system can be kept in good working condition, only if it is carefully and periodically inspected and serviced. But the conventional ignition system using a contact breaker may not satisfy the following additional requirements:

\*To supply a positive spark to the engine at the correct time over the entire range of rpm's.

\*To keep high, dependable performance without particular maintenance or service for a long period. The pointless ignition system using no mechanical contact breaker has its own turn here.

The capacitor discharge ignition system and the transistor controlled ignitor are the most popular systems of this kind. (see our last issue for the C.D.I.)

The XS1100, XS750, etc. are fitted with the transistor controlled ignitor (T.C.I.).

## Characteristics

The Yamaha T.C.I. has the following characteristics:

1. This system uses a pick-up coil and reductor's pulse sign instead of the contact breaker, thus producing a positive spark for sure ignition over the entire range of rpm's from idling speed to top speed.
2. This system using no mechanical points keeps its high, dependable performance for a long time without periodical maintenance or inspection, thus needing only occasional tune-up service.
3. The flow of current in the primary winding is automatically interrupted by a cut-out circuit when the engine stalls. This prevents

the waste of electricity in the battery and other troubles.

4. The flow of current in the primary winding is regulated by a time control circuit, thus minimizing the waste of electricity especially when the engine runs at low speed.

## Functional mechanism of the T.C.I.

There are three types of ignition as follows:

1. Impressed voltage type
2. Current interruption type
3. Compromise type between 1 and 2

The T.C.I. falls under type 2 while the C.D.I. belongs to type 1. The T.C.I. uses in principle a transistor in place of the contact breaker of a conventional battery ignition system.

A magnetic pulse produced in the pick-up coil switches the transistor off at the correct time to cut the current flow in the primary winding of the ignition coil, thus producing a surge of high voltage in the secondary winding. (see fig. 1 & 2)

## Construction

As shown in fig. 1 and 2, the T.C.I.

system consists of the following components:

1. Ignition timing pulse generator consisting of a pick-up coil, magneto and reductor.
2. Control amplifier (T.C.I. unit) to switch power transistor "on" or "off" through pulse sign produced in pick-up coil.
3. Ignition coil designed specifically for the T.C.I.

These components are all highly dependable in their performance.

A magnetic pulse produced in the pick-up coil is a delicate electrical sign. Therefore, any contact failure in the winding prevents it from working well. Inspect this winding for any contact failure first when the T.C.I. system becomes inoperative. If this winding is disconnected from the system, reassembling must be performed with special care.

The T.C.I. system has no contact breaker and a timing light is needed to check the timing.

(no conventional point checker can be used on this system)

Individual components are designed and constructed so that they can meet the specific operating conditions of our respective models.

Please see each model's service manual for more details.

# Transistor Controlled Ignitor

Fig. 1: When the main switch is "on" current flow takes the following passage:

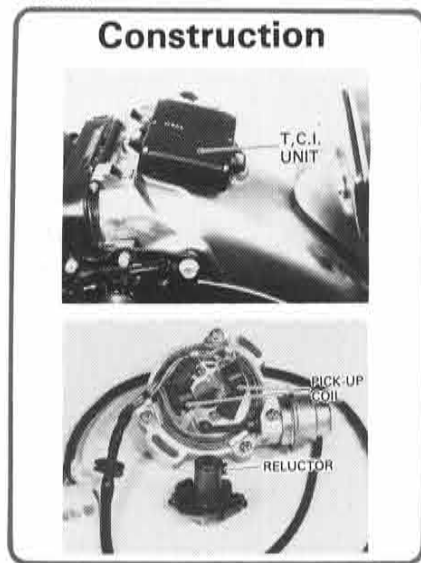
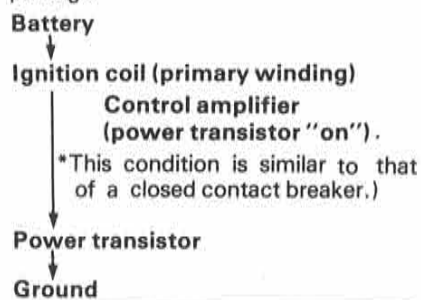
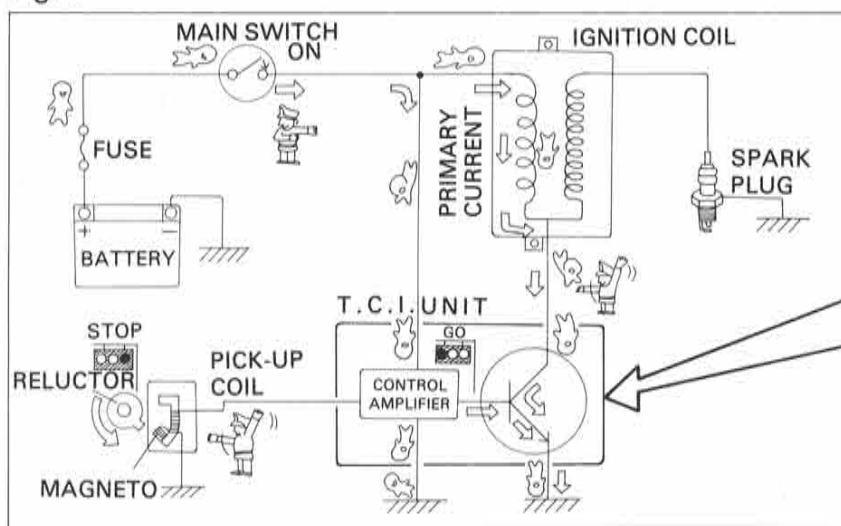

Fig. 2: A pulse sign is produced when the projecting portion of the rotating reductor passes the core of the pick-up coil. The pulse sign switches the power transistor "off" through the control amplifier.

\*This condition is similar to that of an opened contact breaker.

Fig. 1



## Basic function of switching transistor

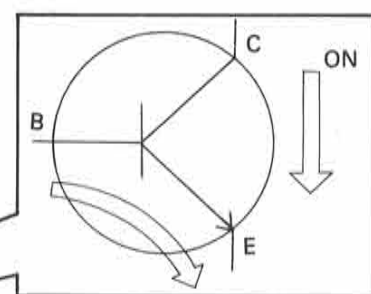

Base current is induced to B-E, giving conductivity to C-E. This condition is similar to that of a closed point. In this case, large amount of electricity can be sent to C-E by using small amount of electricity in B-E.

Fig. 2

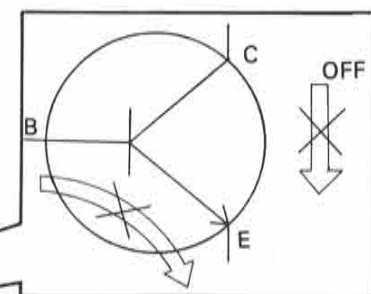
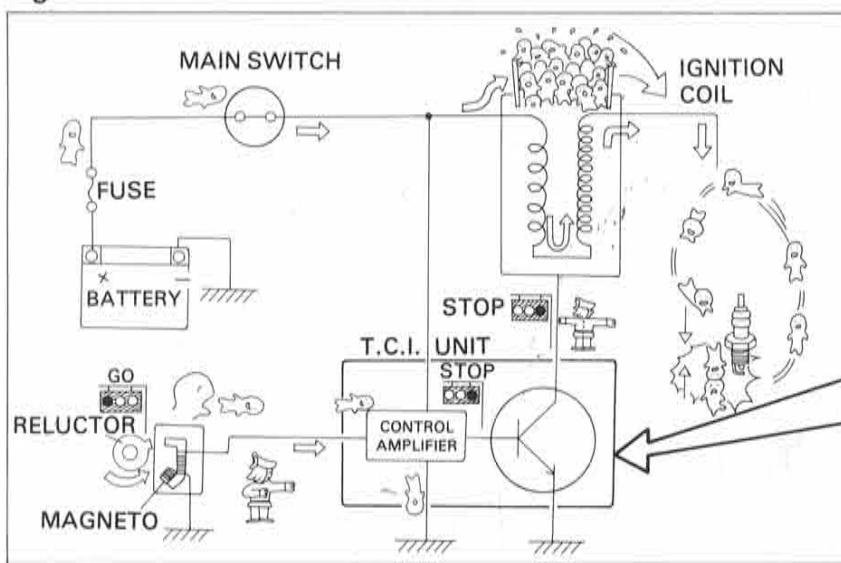

The moment base electricity is cut in B-E, electricity to C-E is also cut. Thus, large amount of electricity can be controlled by using small amount of electricity.

# All-new compact model

**NEW MODEL**

Yamaha's popular compact, lightweight model 2A has been renamed "2B" along with the introduction of numerous technical improvements. Among these improvements are the newly fitted recoil hand starter, full sealed type apron and rear handhold as well as an improved fuel cock and throttle lever. The top cowling's graphic is also improved and refined overall. The new 2B will surely bring every marine pleasure seeker a fresh, delightful boating life.

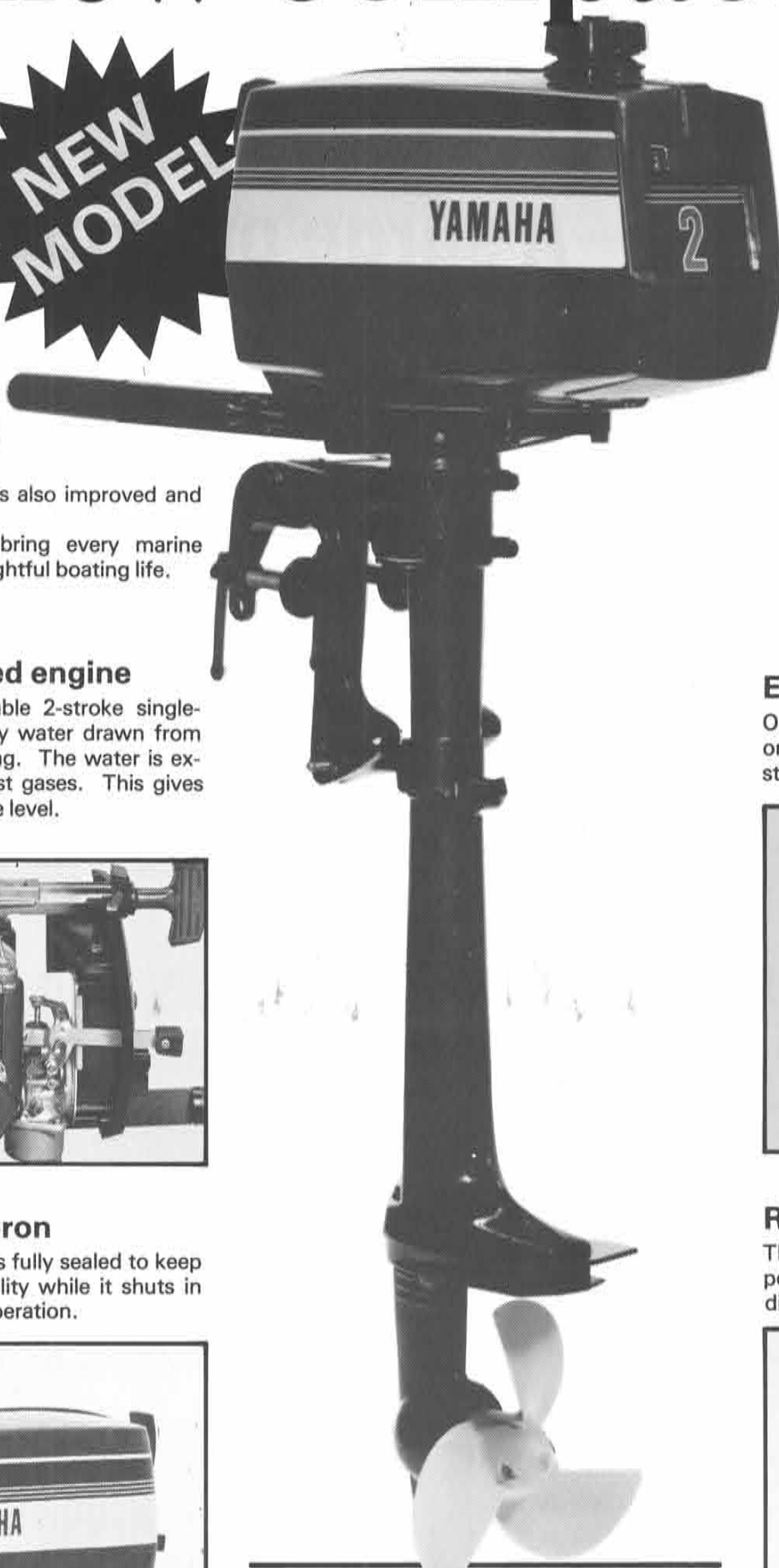

**SPECIFICATIONS**

Engine type	2-stroke, Single
Maximum output	2 HP (1.5KW)/5,000 r.p.m.
Displacement	43 cc (2.58 cu.in.)
Bore & Stroke	39 x 36 mm (1,535 x 1,417 in.)
Ignition system	Flywheel magneto
Starting system	Recoil handstarter
Cooling system	Water
Controls	Full pivot steering, throttle lever
Gear shift	Direct
Gear ratio	2.08 (27/13)
Propeller size	3 x 184 x 114 mm (Blade x Dia x Pitch) (3" x 7 1/4" x 4 1/2")
Transom height	(S) 15 in.
Tilting position	4-stages
Fuel	Gas-oil mixture (50:1)
Fuel tank capacity	1.2 lit (0.317 US gal.)
Weight(S)	9.8 kg (23.0 lbs)
Service tool kits	STD

\*Specifications are subject to change without prior notice.

**Quiet, water-cooled engine**

The compact yet dependable 2-stroke single-cylinder engine is cooled by water drawn from the sea or lake while cruising. The water is expelled together with exhaust gases. This gives the model an extra low noise level.

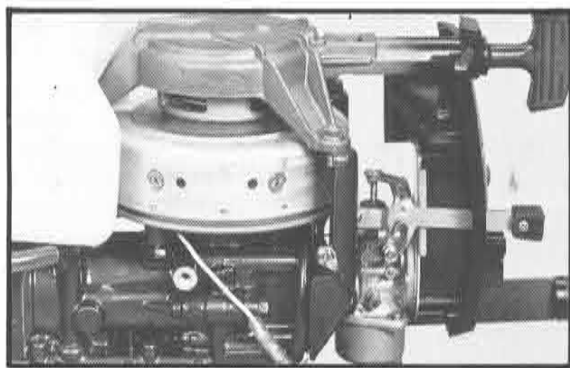

**Extra ease of operation**

Operation is extra easy with all controls grouped on the front panel, along with the full-pivot type steering system.

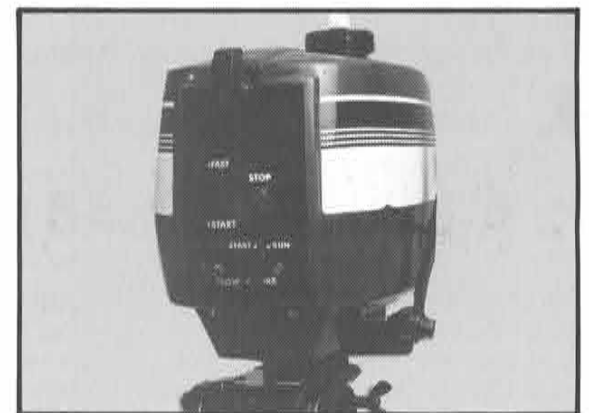

**Full sealed type apron**

The newly designed apron is fully sealed to keep out water for higher durability while it shuts in the engine noise for quiet operation.

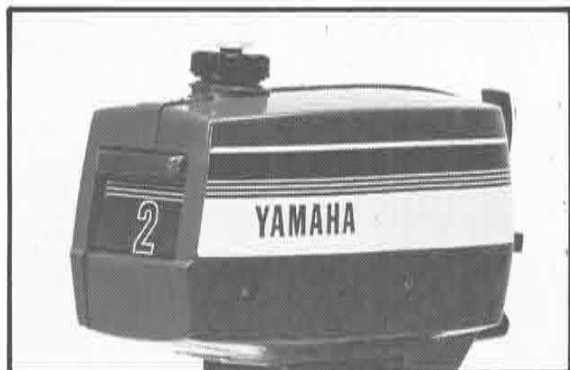

**Recoil hand starter**

The newly fitted recoil hand starter ensures positive starting. It eliminates the trouble of winding a rope around the pulley.

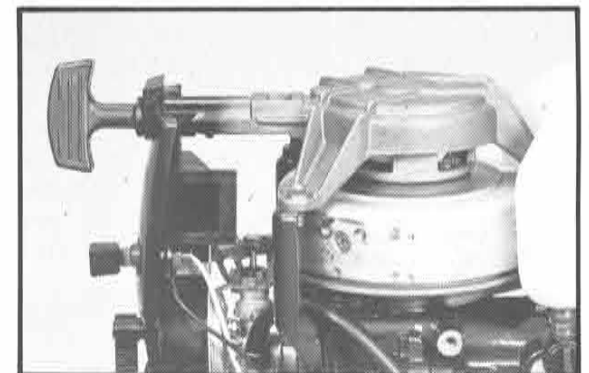

**Reed valve intake system**

Intake and combustion efficiency are greatly improved by the newly designed reed valve intake system. The amount of fuel is automatically adjusted in accordance with the engine's speed.

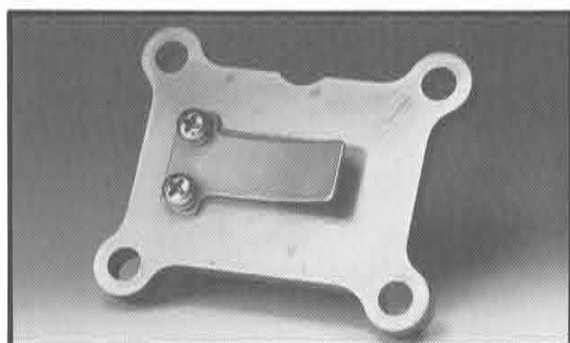

**Built-in fuel tank**

The built-in fuel tank holds 1.2 liters of gasoline. This amount is quite enough for practical cruising as the new model features improved fuel economy.

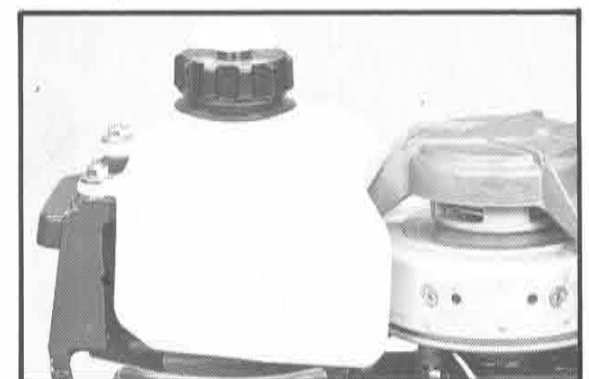

**YAMAHA 2B**





# The V80 introduces inspiring all Ind

## A surge of excitement abo

The Yamaha V75, which has been one of the best selling family bikes all over the world, especially in Southeast Asia, is now renamed V80 (Y80) featuring a newly designed 80cc engine. This model is introduced in the center pages (colored) of this issue.

The V80 has basically same styling as the popularity-winning V75 but performance data, such as power output, acceleration, climbing ability, etc., are all improved. In addition, fuel economy is improved.

It is very important for all salesmen to make these advantages known to the buying public in Indonesia.

P.T. Harapan Motor Sakti Industry Co., Yamaha's general importer in Indonesia, has recently launched a large-scale V80 introduction campaign around all major cities.

The campaign brought an excellent response from the buying public and all first-line dealers were greatly inspired by this success.

A lot of excitement is arising even before the new model has been put on the market.

The following is a report of this successful campaign:

### All forces joined together

The V80 introduction campaign, which began early in July and is making steady progress as scheduled, will last for four months until the first-Nov., covering all the major cities of Indonesia. This is the first campaign of its kind in a long time, and public response is much more favorable than anticipated.

As a matter of fact, some had a fear that the campaign might be unsuccessful as the new model looked all the same as its sister model V75 and would not appeal to novelty-minded customers.

But we are very happy to report you that we have been favorably surprised since the campaign started.

We now realize that users prefer performance to styling.

The main aim of this campaign is to give our dealers a strong impression of the new V80, though it features basically same styling as the V75. To this end, all first-line salesmen have been invited to test ride the new model firsthand so that they can sense numerous technical improvements. At the same time, service seminars have been organized in order to strengthen our system of after-sale service and parts supply with the backing of higher service/repair technology.

Thus, all the staff of Harapan Motor's motorcycle sales, service and parts sales have joined forces to promote the campaign with full support given by the service staff of Yamaha Motor.

Plans have been laid to promote the following 3-day program in each strategic place:

1st day — introduction of V80 sales points and test-ride of the new

model.

2nd and 3rd days—service seminar.

### Outstanding acceleration and climbing ability; surprising fuel economy

#### 2nd & 3rd days—service seminar

On the first day, we give a full explanation of the sales points of the new model as it is shown to the dealers. Pamphlets showing a number of illustrations help them understand our explanations better.

The explanation is focussed on acceleration, climbing ability and fuel economy, emphasizing that these points should be truly appealing to Indonesian customers.

To give substance to our explanation,

all the dealers are invited to test ride the new model on the afternoon of the first day. They have a chance to ride the new V80 as well as the V75 and several models of other brands in the same class.

Everybody is convinced that the enlarged engine delivers higher power. Very few, however, believe that the enlarged engine would feature even better



These booklets are prepared for this campaign. One introduces the outline of the new model and the other is used for a service seminar.

Acceleration test. The V80 leads other models by big margins.



The picture fails to show how steep the slope is but the V80 displays by far the best performance in this climbing test.



Dealers are invited to test ride the new model before it is introduced on the market. This is the first attempt of its kind ever realized in Indonesia. Acceleration, climbing ability and fuel consumption are tested.

# Introduction campaign is enthusiastic among dealers about the forthcoming model



Dealers are attending a service seminar with enthusiasm

fuel economy. The results of the test give substance to its claimed fuel consumption in the most convincing manner. For the sake of "fairness", all dealers are allowed to ride all test models one by one. In SS 400m the new V80 leads all others by 20 to 30 meters. The best performance in climbing ability is also shown by this model. Fuel consumption is tested over a 20 to 30km run. The new V80 consumes the least amount of fuel of all. This surprises even experts. Those dealers who are strongly impressed by the new model, attend a 2 - day service seminar on the second day with enthusiasm. They learn how to adjust ignition timing without a dial gauge; how to diagnose carb. troubles; how to keep the air cleaner in good working condition; how to handle the bat-

tery; how to measure the charging voltage; how to diagnose engine troubles in connection with piston clearance, etc. The seminar attains very good results.

## All dealers are enthusiastic

The above 3-day program has been successfully promoted everywhere. Every dealer who takes part in this campaign, is greatly inspired by the new model when he test rides it. All dealers are now excited and waiting eagerly for its debut on the market.



Attended by a large number of dealers.....



A relatively small number of participants.....

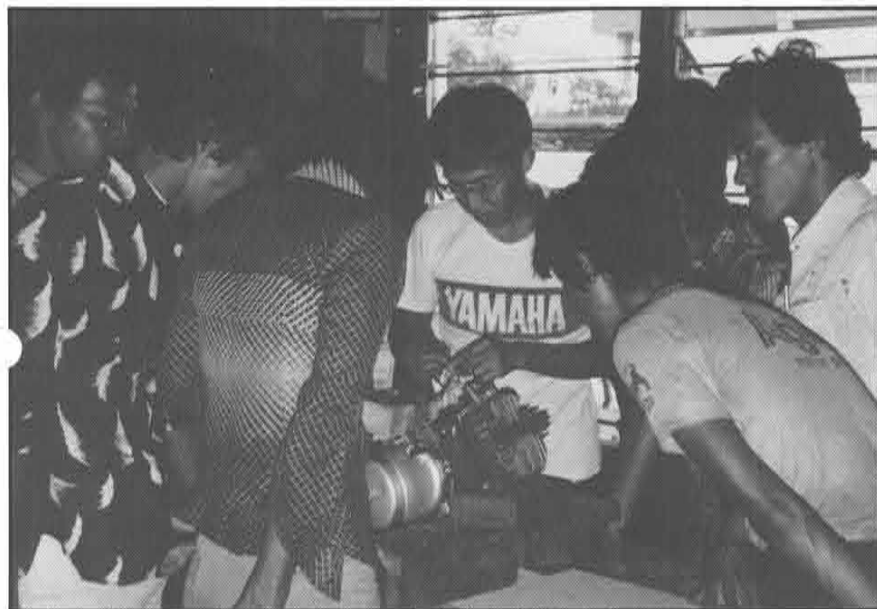

Timing adjustment practice on the newly designed V80 engine.

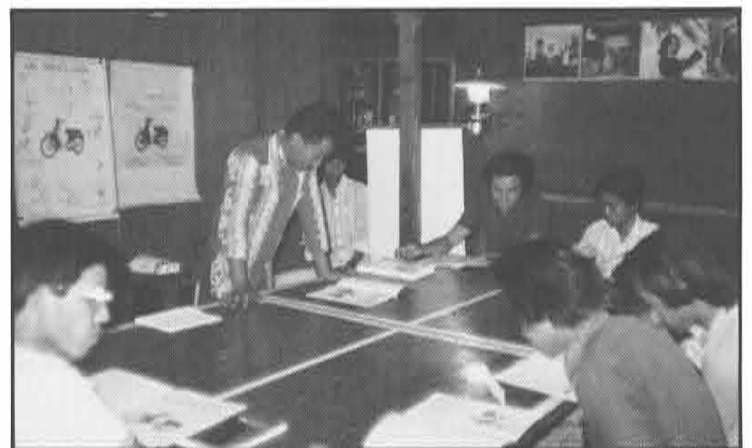

Pingpong tables and lamps are used for this particular purpose.



The 3-day V80 introduction campaign is creating fresh enthusiasm for business. All servicemen have got more confidence in Yamaha products.

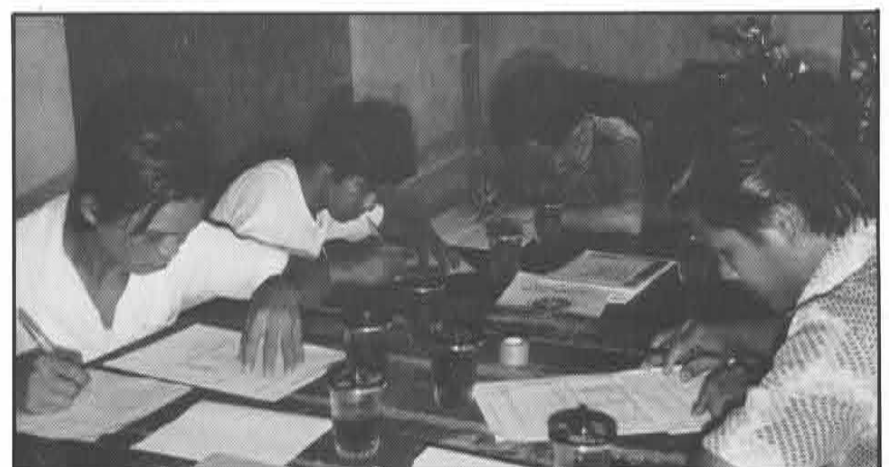

Paper test is also given.

## Technical series

# Service & Maintenance

You should strive to maintain a positive attitude toward improving your level of repair/service techniques and knowledge so that you can see every customer use his or her Yamaha bike in the best operative condition. This technical series has been designed with this in mind and provides proper coverage of the fundamentals required for every Yamaha serviceman. Gain more through elevating the brand image of Yamaha!

*(These pages should be kept long and fully utilized for your better service work.)*

# AIR CLEANER

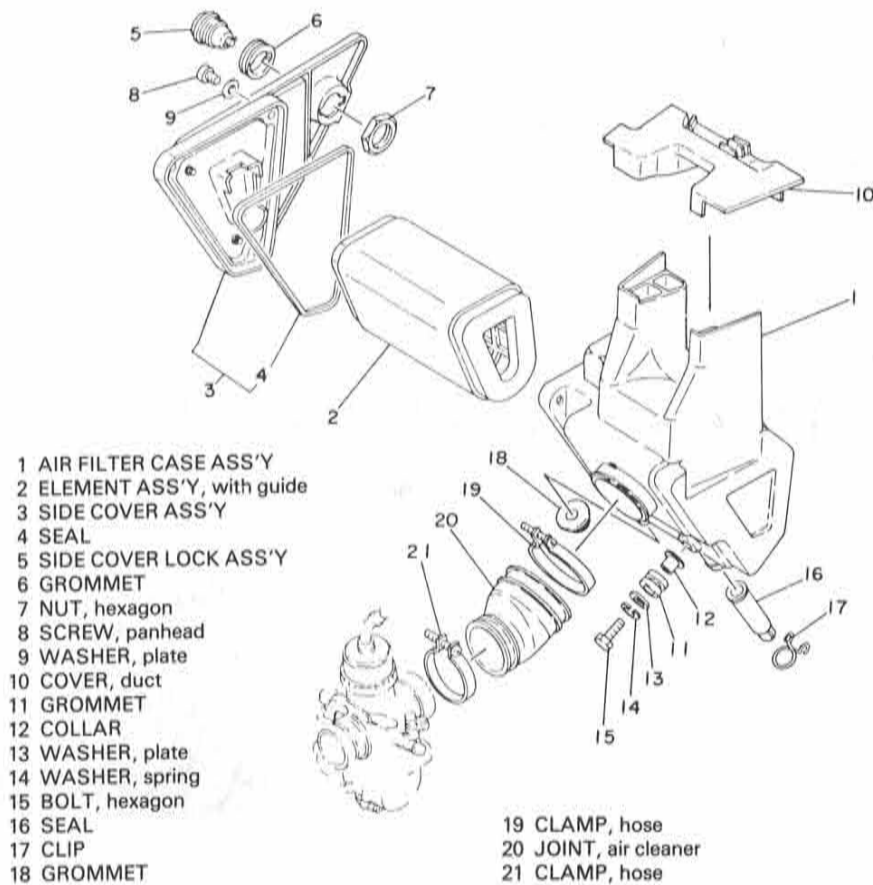

## Clogged element results in lower power and more fuel consumption

\* If the element is left dirty and clogged, the amount of air intake is limited, causing power loss and more fuel consumption.

Cleaner elements are broadly classified into the following three types:

1. Dry paper type
2. Foam rubber type (dry)
3. Foam rubber type (wet)

\* The element should be cleaned after each 3,000-km run. This must be observed especially when the bike is often used in dusty condition.

In the case of the dry paper type, air resistance becomes stronger per  $\text{cm}^2$  and therefore, the element paper is folded in a radial manner so that total filtering area is enlarged to reduce air resistance as a whole.

Both foam rubber types feature less air resistance and higher filtering performance. In particular, the wet foam rubber type draws dust and dirt to its oily surface for even better filtering.

\* If the element is found to be especially dirty, cleaning should be done at closer intervals. In case it is extremely dirty, a new one must be used.

Lubrication is very important in an engine where various metallic components are rotating in constant friction with each other. Also, equally important is the function of an air cleaner.

It is a matter of common knowledge that piston seizure is caused by poor lubrication. But, very few people know that a faulty air cleaner spoils engine performance.

Unlike that of the ignition or fuel feeding system, a defect in this device does not instantly lead to the total failure of engine performance.

For this reason users are liable to neglect a periodic inspection on it. How does it function? It has a function similar to that of a face mask. It shuts out dirt and dust drifting in the air while you are riding a bike, thus inducting clean air into the engine. One more function is to hold the noise of air intake to a low level

while air is induced into the engine. The air cleaner consists of an element and its case. The shape, capacity, air passage and element material are designed or selected so

## Air cleaner for higher engine performance and durability

that they fit the performance of the engine and intended use of the bike. The engine of a road racer is not fitted with this device but this is an exception. The road racer is designed

and built to run exclusively on a completely prepared surface, and within a limited period of time.

Similarly, no air cleaner is needed on snowmobile and outboard

engines in consideration of their operating conditions. Some other noise-lowering measures are taken for these types of engines.

On the contrary, the air cleaner is in-

dispensable to any motocross machine which is used in extremely dusty conditions. No motocross machine could pass a goal line without an air cleaner.

As stated elsewhere, there are three different types of air cleaner elements. The element must be periodically cleaned.

The element becomes clogged if left uncleaned for a long time. This will change the amount of air intake, thus having a bad influence on the mixing ratio of fuel and air. This will gradually spoil the performance of the engine.

Follow the service instructions and have your customers use their bikes in good working condition.

## Cleaning method by type

Dry paper filter

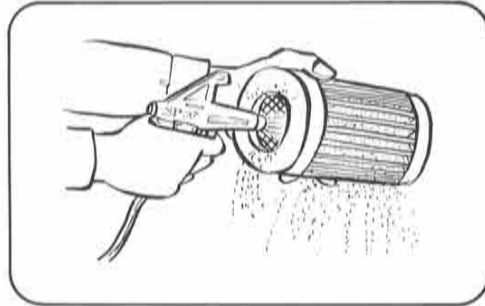
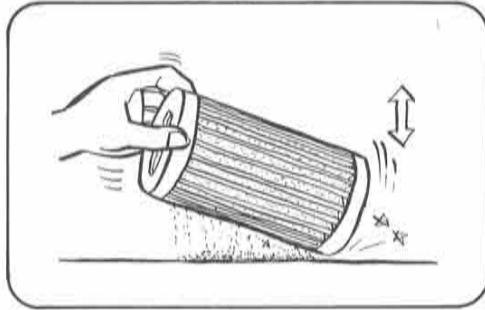
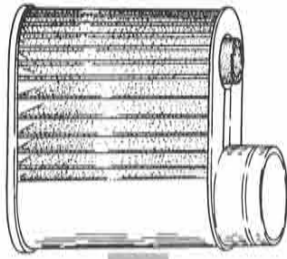

**1. Dry paper type**  
Remove dirt and dust by tapping. Use an air compressor to blow the air against the inside of the element.

Dry foam rubber

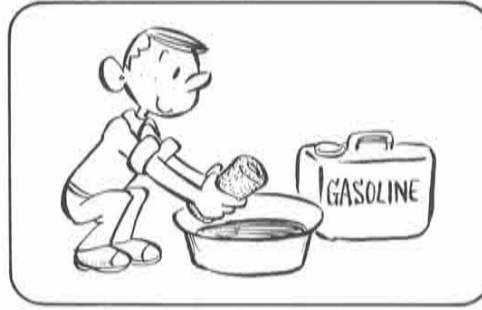
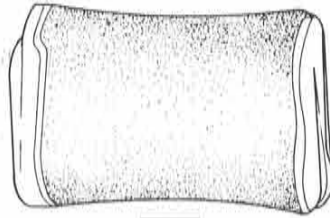

**2. Dry foam rubber type**  
You may use gasoline to clean the dry foam rubber type. In this case, make sure that it is completely dried up before replacing.

Oiled foam rubber

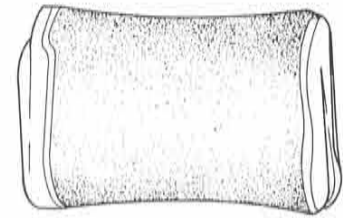

**3. Oiled foam rubber type**  
Clean the element with gasoline. Swish off the gasoline and keep the element in 2-stroke engine oil until it becomes oily enough to give out a touch of oil when pressed lightly with the hand. Excess oil must be squeezed out.

## Q & A corner

This is a new series. Every kind of question will be answered here. If you have any questions to ask on motorcycle mechanics, service/maintenance, riding technique and any other subjects, please do not hesitate to contact us at the following address:

"Yamaha News" Editorial Room  
AD & PR Division  
2500 Shingai, Iwata-shi, Shizuoka-ken (Japan)  
Code No. 438

plugs are suitable for Yamaha models

Mr. Joe Lee, Singapore



**A** The following table will be of some use to you:

As stated in our last issue, heat range is a means of designating how hot a spark plug will run in operation. Even a spark plug in the same engine will be exposed to varying temperatures according to operating conditions. In addition, the method of designating heat ranges is not standardized.

In case a spark plug is found to be sooty, you should replace it with

the next hotter type one. On the contrary, if it is burnt bleached white, use the next colder type one.

When you replace the spark plug with a different brand one, you must take it into account that both brands have not always the same standards of heat range. An incorrect heat range might worsen the situation.

**Q** I have ridden a Yamaha bike for the past five years. Many of my fellow motorcyclists are also ardent Yamaha fans. I want to know what kinds of spark

## For your information

### 1. Dry paper element

- \* FS models
- \* V(Y) models
- \* RX100/125 (Thailand)
- \* RD250/400
- \* DX100

### 2. Dry foam rubber element

- \* XS models
- \* SR500

### 3. Oiled foam element

- \* DT models
- \* RS models
- \* RX models
- \* RD50/125/200
- \* XT, TT models
- \* YB models
- \* YZ, MX models

## Spark plug model numbers by manufacturers (selected)

NGK	DENSO	HITACHI	CHAMPION	BOSCH	AC	AUTOLITE	KLG	LODGE	MARCHEL
BP4HS	W14FP-L	M46-PW	L-89CM	W145-T35	46/45FES	AE82/62	F55P	BNY, CNY	
BP5ES	W22EP	L46-PW	N-8Y	W8D, W160T30	45/44XL	AG52/42	FE55P	BLNY	
B6HS	W16FP	M46W	L-86	W175T1	44FF	AE4	F70	CC14	35B
BP6ES	W20EP	L45-PW	N-8Y	W7D, W175T30	43XL	AG32	FE65P	CLNY	35HS
B7HS	W22FS	M42W	L-81/82	W225T1	42FF	AE3	F75	H14, HN	34S
B7ES	W22ES	L44W	N-4	W225T2	43XL	AG3	FE75	HLNP	35HS
BP7ES	W22EP	L44-PW	N-7Y	W230T30	42XLS	AG22	FE125P	HLNY	
B8ES	W24ES	L44W	N-3	W240T2	42XL	AG2		HF2HL	34HS
D8EA	X24ES-U	L23W	A-8Y	W7D	S120XL	HG2			
B9ES	W27ES		N-60		41XL	AG901	FE100	2HLN	

# Be a top Yamaha dealer

Part 1

## Shop functioning is important

What is the most important factor that causes customers to buy? To make generalities, of course, price, quality, design, service and convenience are important. But quality and design of mass produced products, like motorcycles, are generally all the same. Prices do not vary much either.

The important factors then are service and convenience along with the choice and availability of different models which a shop can offer. Different shops have different kinds of service, convenience and product availability. In this context, what differentiates a shop from another lies in good shop functioning. Service, which is a dimensional and spiritual element, is used to give customers satisfaction, while convenience, which is a geographical element,

is important since a shop must be located where it can be easily reached by the public. Another important factor is product availability, which is based on a major management policy and is restricted by the amount of available shop space and the shop layout.

We can say that a shop which offers service, convenience and availability, does more than half of the job of selling.

In this series, we will explain the functioning of a successful shop and examine what factors are involved in gaining customer trust. We have used many photos, illustrations and shop models to make this series easy to understand.

### 1 What makes a shop more attractive and thriving?



We hear everyone say, "That shop is much talked about in the town." Then, why does it create a sensation?

There is no single, easy answer. Rather, it is a combination of factors, including pricing policies, quality of service and overall appearance. In the following items, we will examine the basic elements involved in making a shop more attractive and inviting.



#### 5 Staging

A shop is like a stage, on which the manager plays the leading role. Products play supporting roles, while sales personnel and other employees are the stagehands. To

make a good performance, the design and arrangement of shapes, colors, lighting and other properties must be done well.

### 3 Yamaha logo and mark

A strong support to a shop manager and a symbol of reliability



The Yamaha logo and mark were created after a careful study to have maximum impact on the international public, while portraying Yamaha as a "reliable" company. The "reliability" of a shop can be enhanced by effectively using the Yamaha logo and mark to unify advertising, in-shop activities and other sales promotion elements. And successful image identification makes the consumer prefer to buy "his or her desired brand" products with confidence.



### 2 Five elements of a successful shop

The five most important elements of a successful shop are listed below.

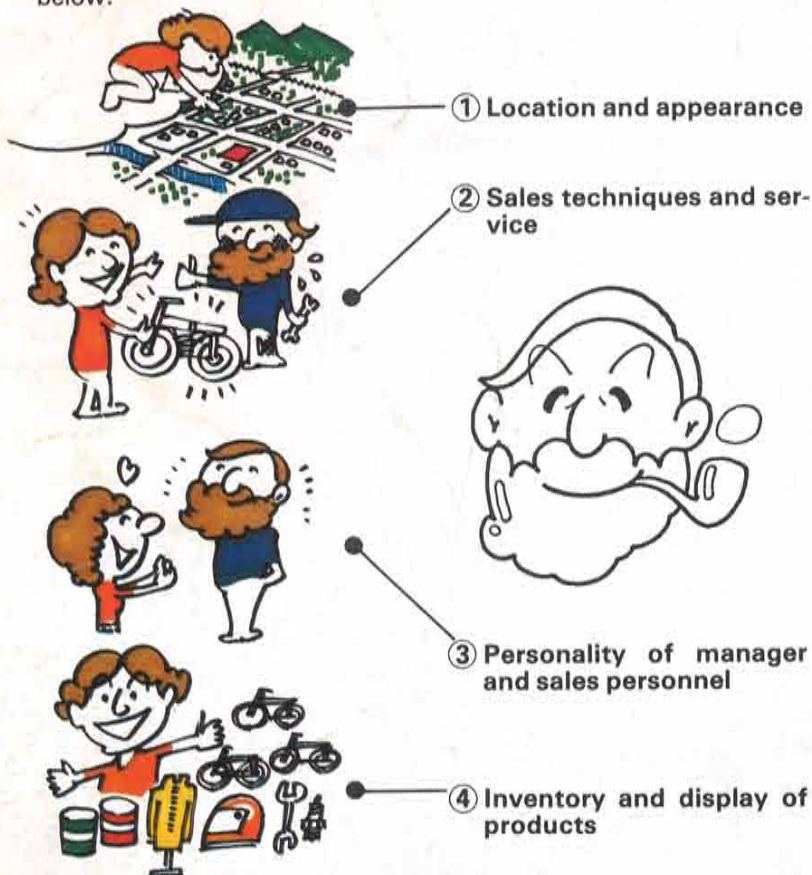

All Yamaha products have already passed severe inspection before they are shipped. To be successful, you must pay similar attention to creating your shop's image. Forming the proper image by use of Yamaha's logo and mark will give you and your shop a reputation for reliability.