

# HXYx 2 axes

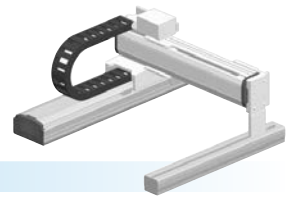

- Gantry type
- Cable carrier

## Ordering method

### HXYx - C

Model	Cable	Combination	X-axis stroke	Y-axis stroke	Cable
G1			25 to 125cm	25 to 105cm	3L: 3.5m
G2					5L: 5m
G3					10L: 10m
G4					

### RCX320-2

Controller / Number of controllable axes	Safety standard	Regenerative unit	Option A (O.P.A)	Option B (O.P.B)	Vision System	Absolute battery
		<b>R</b>				

Specify various controller setting items. RCX320 ▶ **P.660**

### RCX222HP

Controller	Usable for CE	Regenerative unit	I/O selection 1	I/O selection 2
		<b>R</b>		

Specify various controller setting items. RCX222 ▶ **P.670**

## Specification

	X-axis	Y-axis
<b>Axis construction</b> <small>Note 1</small>	F20	F17
<b>AC servo motor output (W)</b>	600	400
<b>Repeatability</b> <small>Note 2</small> (mm)	+/-0.01	+/-0.01
<b>Drive system</b>	Ball screw φ20	Ball screw φ20
<b>Ball screw lead</b> <small>Note 3</small> (Deceleration ratio) (mm)	20	20
<b>Maximum speed</b> <small>Note 4</small> (mm/sec)	1200	1200
<b>Moving range (mm)</b>	250 to 1250	250 to 1050
<b>Robot cable length (m)</b>	Standard: 3.5 Option: 5,10	

- Note 1. Use caution that the flame machining (installation holes, tap holes) differs from single-axis robots.  
 Note 2. Positioning repeatability in one direction.  
 Note 3. Leads not listed in the catalog are also available. Contact us for details.  
 Note 4. When the X-axis/Y-axis stroke is longer than 850mm, resonance of the ball screw may occur depending on the operation conditions (critical speed). In this case, reduce the speed setting on the program by referring to the maximum speeds shown in the table below.

## Maximum payload (kg)

Y stroke (mm)	XY 2 axes
250 to 1050	50

## Controller

Controller	Operation method
RCX320-R	Programming / I/O point trace / Remote command / Operation using RS-232C communication
RCX222HP-R	

## HXYx 2 axes G1

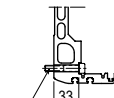
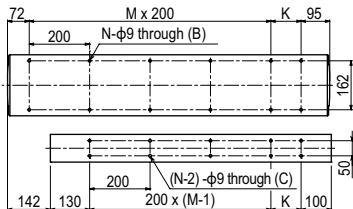
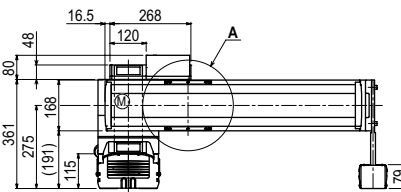
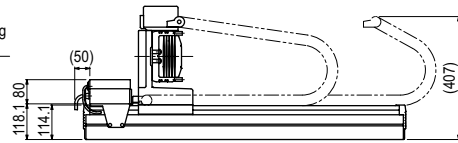
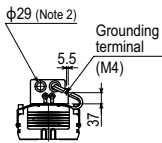
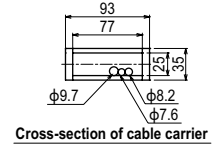
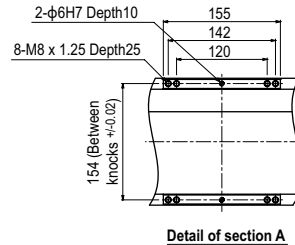
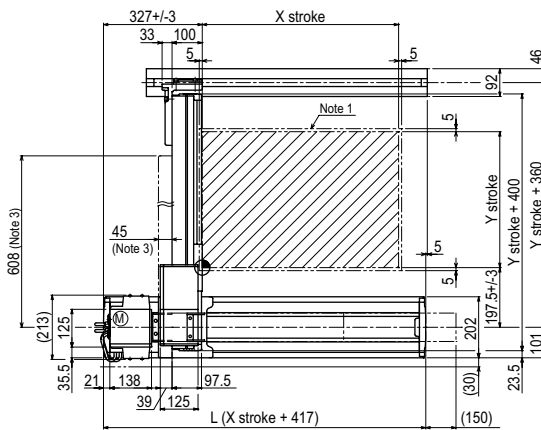

Use M8 x 1.25 hex socket head bolt with length head bolt with length (under head) of 45mm or more.



Use M8 x 1.25 hex socket head bolt with length head bolt with length (under head) of 25mm or more.

X stroke	250	350	450	550	650	750	850	950	1050	1150	1250
<b>L</b>	667	767	867	967	1067	1167	1267	1367	1467	1567	1667
<b>K</b>	100	200	100	200	100	200	100	200	100	200	100
<b>F</b>	420	420	600	600	780	780	960	960	1140	1320	1320
<b>M</b>	2	2	3	3	4	4	5	5	6	6	7
<b>N</b>	8	8	10	10	12	12	14	14	16	16	18
Y stroke	250	350	450	550	650	750	850	950	1050		
<b>Maximum speed for each stroke (mm/sec)</b> <small>Note 4</small>	<b>X-axis</b>		1200		960		840	720	600	480	
	<b>Y-axis</b>		1200		960		840	720			
<b>Speed setting</b>			-		80%		70%	60%	50%	40%	

- Note 1. The moving range when returning to origin and the stop position when stopping by the mechanical stopper.  
 Note 2. User cable extraction port.  
 Note 3. Dimension of reinforced bracket (To be installed when the Y stroke is 750mm or longer)

Note 4. When the X-axis/Y-axis stroke is longer than 850mm, resonance of the ball screw may occur depending on the operation conditions (critical speed). In this case, reduce the speed setting on the program by referring to the maximum speeds shown in the table at the left.

HXYx 2 axes **G2**

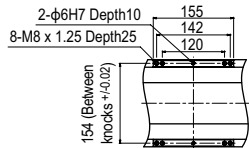

Detail of section A

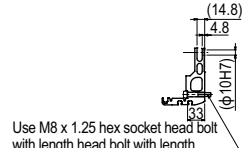

Detail of section B

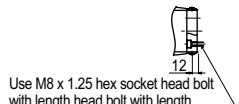

Detail of section C

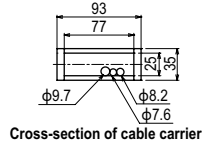

Cross-section of cable carrier

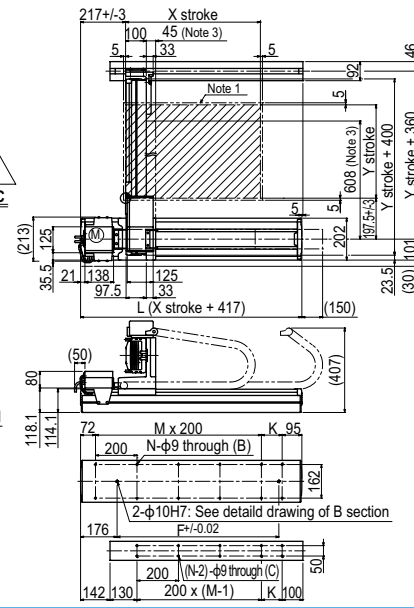
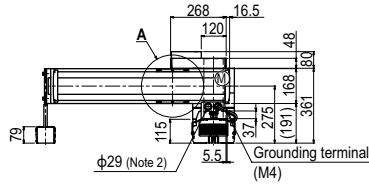

HXYx 2 axes **G3**

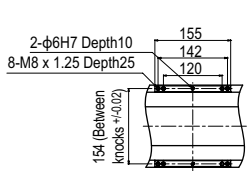

Detail of section A

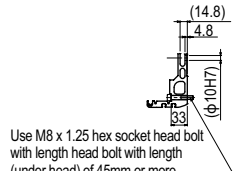

Detail of section B

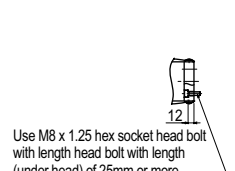

Detail of section C

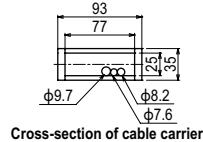

Cross-section of cable carrier

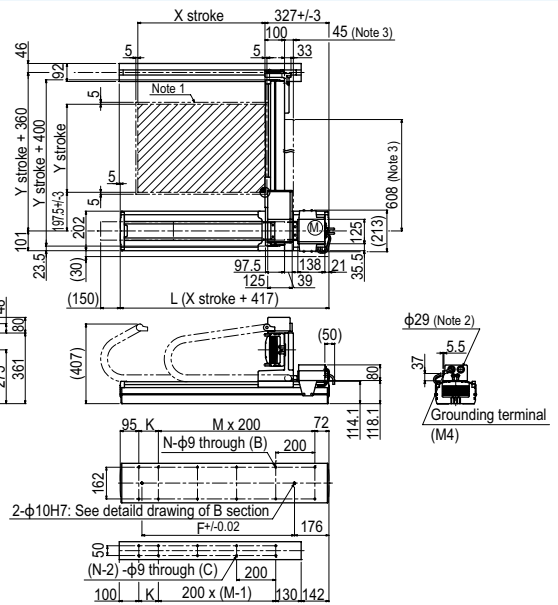
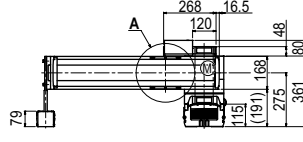

HXYx 2 axes **G4**

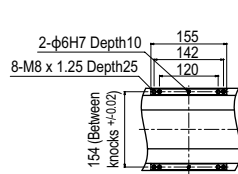
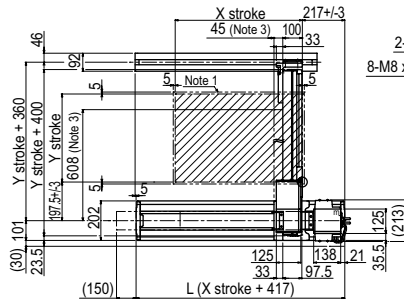

Detail of section A

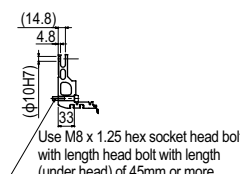

Detail of section B

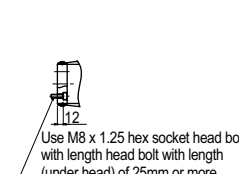

Detail of section C

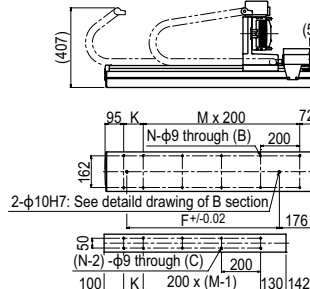

Cross-section of cable carrier

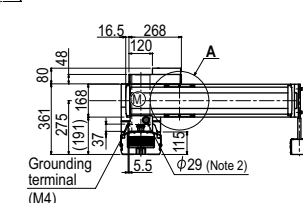

YA	Articulated robots
LCM	Linear conveyor modules
CX	Single-axis robots
Robonity	Motor-less single axis actuator
TRANSEVO	Compact single-axis robots
FLIP-X	Single-axis robots
PHASER	Linear motor single-axis robots
XY-X	Cartesian robots
YK-X	SCARA robots
YP-X	Pick & place robots
CLEA INFORMATION ER	INFORMATION
Arm type	Arm type
Gantry type	Gantry type
Moving arm type	Moving arm type
Pole type	Pole type
XZ type	XZ type