



Articulated robots YA
Linear conveyor modules LCM
Single-axis robots CX
Motor-less single axis actuator Robomity
Compact single-axis robots TRANSEVO
Single-axis robots FLIP-X
Linear motor single-axis robots PHASER
Cartesian robots XY-X
SCARA robots YK-X
Pick & place robots YP-X
CLEAN
CONTROLLER
INFORMATION
T type
F type
GF type
N type
B/R type

SINGLE-AXIS ROBOTS

FLIP-X

SERIES

CONTENTS

■ FLIP-X SPECIFICATION SHEET ...296	GF17XL320
■ Robot ordering method description298	F20321
■ Robot ordering method terminology299	F20N323
T TYPE FRAME-LESS STRUCTURE MODEL	N TYPE NUT ROTATION TYPE MODEL
T4L 300	N15324
T4LH301	N15D326
T5L302	N18328
T5LH303	N18D330
T6L 304	B TYPE TIMING BELT DRIVE MODEL
T9 305	B10332
T9H 306	B14 334
F TYPE / GF TYPE HIGH RIGIDITY FRAME MODEL	B14H336
F8307	R TYPE ROTATION AXIS TYPE MODEL
F8L 308	R5338
F8LH 310	R10339
F10 311	R20 340
F10H 312	
F14 314	
F14H 315	
GF14XL 316	
F17 317	
F17L 319	

FLIP-X SPECIFICATION SHEET

Type	Model	Motor output (W)	Repeat-ability (mm)	Lead (mm)	Payload (kg)		Stroke (mm) and maximum speed (mm/s)																					
					Horiz-ontal	Ver-tical	50	100	150	200	250	300	350	400	450	500	550	600	650	700	750	800	850	900	950	1000		
T type	T4L/ T4LH	30	+/-0.02	12	4.5	1.2	720																					
				6	6	2.4	360																					
				2	6	7.2	120																					
	T5L/ T5LH	30	+/-0.02	20	3	-	1200										960	840	720	660								
				12	5	1.2	800										640	560	480	440								
				6	9	2.4	400										320	280	240	220								
	T6L	60	+/-0.02	20	10	-	1333										1133	1000	866	800								
				12	12	4	800										680	600	520	480								
				6	30	8	400										340	300	260	240								
	T9	100	+/-0.01	30	15	-	1800										1440			1170			900					
				20	30	4	1200										960			780			600					
				10	55	10	600										480			390			300					
5				80	20	300										240			195			150						
T9H	200	+/-0.01	30	25	-	1800										1440			1170			900						
			20	40	8	1200										960			780			600						
			10	80	20	600										480			390			300						
			5	100	30	300										240			195			150						
F type	F8	100	+/-0.02	20	12	-	1200										1080	900	780	720	600							
				12	20	4	720										648	540	468	432	360							
				6	40	8	360										324	270	234	216	180							
	F8L	100	+/-0.01	30	7	-	1800										1530	1350	1170	1080	990	900	810					
				20	20	4	1200										1020	900	780	720	660	600	540					
				10	40	8	600										510	450	390	360	330	300	270					
				5	50	16	300										255	225	195	180	165	150	135					
	F8LH	100	+/-0.01	20	30	-	1200										1020	900	780	720	660	600	540	480				
				10	60	-	600										510	450	390	360	330	300	270	240				
				5	80	-	300										255	225	195	180	165	150	135	120				
	F10	100	+/-0.01	30	15	-	1800										1440			1170			900					
				20	20	4	1200										960			780			600					
10				40	10	600										480			390			300						
5				60	20	300										240			195			150						
F10H	200	+/-0.01	30	25	-	1800										1440	1260	1080	900	720	630							
			20	40	8	1200										960	840	720	600	480	420							
			10	80	20	600										480	420	360	300	240	210							
			5	100	30	300										240	210	180	150	120	105							
F14	100	+/-0.01	30	15	-	1800										1440			1170			900						
			20	30	4	1200										960			780			600						
			10	55	10	600										480			390			300						
			5	80	20	300										240			195			150						
F14H	200	+/-0.01	30	25	-	1800										1440			1170			900						
			20	40	8	1200										960			780			600						
			10	80	20	600										480			390			300						
			5	100	30	300										240			195			150						
F17	400	+/-0.01	40	40	-	2400										1920			1680									
			20	80	15	1200										960			840									
			10	120	35	600										480			420									
F17L	600	+/-0.02	50	50	10																							
F20	600	+/-0.01	40	60	-	2400										1920			1680									
			20	120	25	1200										960			840									
			10	-	45	600										480			420									
F20N	400	+/-0.04	20	80	-																							
GF type	GF14XL	200	+/-0.01	20	45	-																						
	GF17XL	400	+/-0.01	20	90	-																						
N type	N15	400	+/-0.01	20	50	-																						
	N15D	400	+/-0.01	20	50	-	1200																					
	N18	400	+/-0.01	20	80	-																						
	N18D	400	+/-0.01	20	80	-																						
B type	B10	100	+/-0.04	-	10	-																						
	B14	100	+/-0.04	-	20	-																						
	B14H	200	+/-0.04	-	30	-																						

Type	Model	Motor output (W)	Repeat-ability (sec)	Speed reduction ratio	Maximum speed (°/sec)	Detailed info page
R type	R5	50	+/-30	1/50	360	P.338
	R10	100	+/-30	1/50	360	P.339
	R20	200	+/-30	1/50	360	P.340

⚠ Precautions for use

- **Handling**
Fully understand the contents stated in the "FLIP-X Series User's Manual" and strictly observe the handling precautions during operation.
- **Allowable installation ambient temperature**
0 to 45 °C

	1050	1100	1150	1200	1250	1300	1350	1400	1450	1500 to 1600	1650	1700	1750	1800	1850 to 2000	2050	2150	2250	2350	2400 to 2500	2550	2650 to 3050	Detailed info page		
																								T4L: P.300 T4LH: P.301	
																									T5L: P.302 T5LH: P.303
																									P.304
	810																								P.305
	540																								P.305
	270																								P.305
	135																								P.305
	810																								P.306
	540																								P.306
	270																								P.306
	135																								P.306
																									P.307
																									P.307
	720																								P.308
	480																								P.308
	240																								P.308
	120																								P.308
	420																								P.308
	210																								P.310
	105																								P.310
	810																								P.311
	540																								P.311
	270																								P.311
	135																								P.311
																									P.312
																									P.312
	810																								P.314
	540																								P.314
	270																								P.314
	135																								P.314
	810																								P.315
	540																								P.315
	270																								P.315
	135																								P.315
	1440	1200	960	840	720																				P.317
	720	600	480																						P.317
	360	300	240																						P.317
		2200	1900	1500	1200	900	800																		P.319
	1440	1200	960	840	720																				P.321
	720	600	480																						P.321
	360	300	240																						P.321
			1200																						P.323
			1200																						P.316
																									P.320
	1200																								P.324
																									P.326
																									P.328
																									P.330
	1200																								P.332
	1875																								P.334
	1875																								P.334
	1875																								P.336

- Articulated robots
YA
- Linear conveyor modules
LCM
- Single-axis robots
CX
- Motor-less single axis actuator
Robonity
- Compact single-axis robots
TRANSEVO
- Single-axis robots
FLIP-X
- Linear motor single-axis robots
PHASER
- Cartesian robots
XY-X
- SCARA robots
YK-X
- Pick & place robots
YP-X
- CLEAN
- CONTROLLER
- INFORMATION
- T type
- F type
- GF type
- N type
- B/R type

Robot ordering method description

In the order format for the YAMAHA single-axis robots FLIP-X series, the notation (letters/numbers) for the mechanical section is shown linked to the controller section notation.

[Example]

● Mechanical ▶ F8

- Lead ▷ 20mm
- Brake ▷ Yes
- Origin position ▷ Non-motor side
- Grease ▷ Standard
- Stroke ▷ 500mm
- Cable length ▷ 3.5m

● Controller ▶ SR1-X

- Usable for CE ▷ Not required
- Regenerative unit ▷ Not required
- I/O selection ▷ NPN
- Battery ▷ With battery

● Ordering method

F8-20-BK-Z-500-3L-SR1-X05-N-B

Mechanical section

Controller section

This page describes using the ordering form for mechanical components.

To find detailed controller information see the controller page.

SR1-X ▶ [P.652](#), TS-X ▶ [P.626](#), RDV-X ▶ [P.640](#)

Mechanical section

● T type / F type (F8 / F8L / F8LH)

① Model	③ Lead designation	④ Brake	⑩ Option	⑪ Stroke	⑫ Cable length
T4L F8	30 30mm	No entry / No brakes	Origin position change / None / Standard		3L 3.5m
T4LH F8L	20 20mm	BK / Brakes provided	Z / Non-motor side		5L 5m
T5L F8LH	12 12mm		Grease type / None / Standard		10L 10m
T5LH	10 10mm		GC / Clean		3K 3.5m
T6L	6 6mm				5K 5m
T9	5 5mm				10K 10m
T9H	2 2mm				

● F type (Except F8 / F8L / F8LH)

① Model	③ Lead designation	④ Brake	⑥ Cable entry location	⑩ Option	⑪ Stroke	⑫ Cable length
F10 F20	50 50mm	No entry / No brakes	No entry / Standard (S)	Origin position change / None / Standard		3L 3.5m
F10H F20N	40 40mm	BK / Brakes provided	U / From the top	Z / Non-motor side		5L 5m
F14	30 30mm		R / From the right	Grease type / None / Standard		10L 10m
F14H	20 20mm		L / From the left	GC / Clean		3K 3.5m
F17	10 10mm					5K 5m
F17L	5 5mm					10K 10m

● GF type

① Model	② Model	⑤ Take out direction	③ Lead designation	⑥ Cable entry location	⑩ Option	⑪ Stroke	⑫ Cable length
GF14XL	S / Straight model	H / Horizontal installation	20 20mm	No entry / Standard (S)	Origin position change / None / Standard		3L 3.5m
GF17XL				U / From the top	Z / Non-motor side		5L 5m
				R / From the right	Grease type / None / Standard		10L 10m
				L / From the left	GC / Clean		3K 3.5m
							5K 5m
							10K 10m

● N type (Single carriage)

① Model	③ Lead designation	⑦ Cable carrier entry location	⑧ Cable carrier specification	⑩ Option	⑪ Stroke	⑫ Cable length
N15	20 20mm	RH / Horizontal, right	S / Standard cable carrier	Origin position change / None / Standard		3L 3.5m
N18		LH / Horizontal, left	M / Optional cable carrier	Z / Non-motor side		5L 5m
		RW / Wall, right		Grease type / None / Standard		10L 10m
		LW / Wall, left		GC / Clean		3K 3.5m
						5K 5m
						10K 10m

● N type (Double carriage)

① Model	③ Lead designation	⑤ Take out direction	⑧ Cable carrier specification	⑩ Option	⑪ Stroke	⑫ Cable length
N15D	20 20mm	H / Horizontal installation	S / Standard cable carrier	Grease type / None / Standard		3L 3.5m
N18D		W / Wall hanging installation	M / Optional cable carrier	GC / Clean		5L 5m
						10L 10m
						3K 3.5m
						5K 5m
						10K 10m

● B type

① Model	⑨ Motor installation direction	⑩ Option	⑪ Stroke	⑫ Cable length
B10	L / Motor leftward, horizontal position	Grease type / None / Standard		3L 3.5m
B14	R / Motor rightward, horizontal position	GC / Clean		5L 5m
B14H	LU / Motor leftward, upper position			10L 10m
	RU / Motor rightward, upper position			3K 3.5m
	LD / Motor leftward, lower position			5K 5m
	RD / Motor rightward, lower position			10K 10m

● R type

① Model	⑥ Cable entry location	⑫ Cable length
R5	No entry / Standard (S)	3L 3.5m
R10	B / From the side	5L 5m
R20		10L 10m
		3K 3.5m
		5K 5m
		10K 10m

Robot ordering method terminology

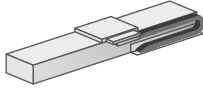
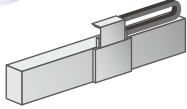
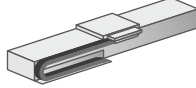
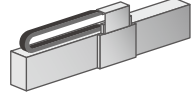
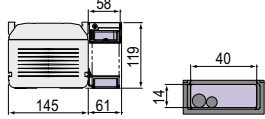
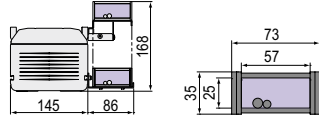
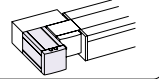
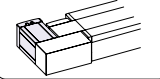
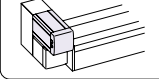
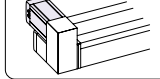
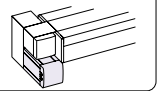
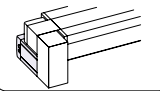
① Model	Enter the robot unit model.
② Model	Straight model only (GF type)
③ Lead designation	Select the ball screw lead.
④ Brake	Select Brake or No-brake. Horizontal specs : No-brake Vertical specs : with Brake
⑤ Take out direction	Select what direction to install the robot (horizontal / wall mounted).
⑥ Cable entry location	Select what direction to extract the robot cable connecting the robot and controller.
⑦ Cable carrier entry location	Select what direction to install the robot (horizontal / wall mounted) and what direction to extract the robot cable carrier. <div style="display: flex; justify-content: space-around; align-items: flex-start;"> <div style="text-align: center;"> <p>RH Horizontal, right</p>  </div> <div style="text-align: center;"> <p>RW Wall, right</p>  </div> <div style="text-align: center;"> <p>LH Horizontal, left</p>  </div> <div style="text-align: center;"> <p>LW Wall, left</p>  </div> </div> <p><small>Note. Be sure to install in the direction as specified (in cable carrier take-out direction drawing and various specification drawings) individually. Installation in any other way will cause a failure. For requirement of installation in any way other than the above standard installation, please consult YAMAHA as special arrangement will be available.</small></p>
⑧ Cable carrier specification	Select the cable carrier size for the customer wiring. <div style="display: flex; justify-content: space-around;"> <div style="text-align: center;"> <p>S type Standard cable carrier</p>  </div> <div style="text-align: center;"> <p>M type Optional cable carrier</p>  </div> </div> <p><small>Note. Cannot pass more than 3 urethane hoses (φ6 x 4). Space for optional cable for users</small></p>
⑨ Motor installation direction	Select what direction to install the motor. <div style="display: grid; grid-template-columns: repeat(2, 1fr); gap: 10px;"> <div style="text-align: center;"> <p>L type Leftward at horizontal position</p>  </div> <div style="text-align: center;"> <p>R type Rightward at horizontal position</p>  </div> <div style="text-align: center;"> <p>LU type Leftward at upper position</p>  </div> <div style="text-align: center;"> <p>RU type Rightward at upper position</p>  </div> <div style="text-align: center;"> <p>LD type Leftward at lower position</p>  </div> <div style="text-align: center;"> <p>RD type Rightward at lower position</p>  </div> </div>
⑩ Option	Origin position change: Origin point position can be changed.
	Frame: Hole to secure the frame can be selected. (Spot facing/tapping)
	Grease type: Clean grease can be selected.
⑪ Stroke	Select the stroke for the robot movement range.
⑫ Cable length	Select the robot cable length to use for connecting the robot to the controller. 3L : 3.5m (Standard) 5L : 5m 10L : 10m 1K : 1m (You can select a 1m cable only when you use T4L/T5L. Flexible cable) 3K : 3.5m (Flexible cable) 5K : 5m (Flexible cable) 10K : 10m (Flexible cable)

Articulated robots YA
 Linear conveyor modules LCM
 Single-axis robots CX
 Motor-less single axis actuator Robotomy
 Compact single-axis robots TRANSEVO
 Single-axis robots FLIP-X
 Linear motor single-axis robots PHASER
 Cartesian robots XY-X
 SCARA robots YK-X
 Pick & place robots YP-X
 CLEAN
 CONTROLLER
 INFORMATION
 T type
 F type
 GF type
 N type
 B/R type

T4L

Origin on the non-motor side is selectable

Controller: 24V



Ordering method

T4L							ERC	
Model	Lead designation	Brake	Origin position change	Grease type	Stroke	Cable length ^{Note 1}	Controller	I/O connector specification
	12: 12mm 6: 6mm Z: 2mm	No entry: No brakes BK: Brakes provided	None: Standard Z: Non-motor side	None: Standard GC: Clean	50 to 400 (50mm pitch)	1K: 1m 3K: 3.5m 5K: 5m 10K: 10m		CN1: I/O flat cable 1m (Standard) CN2: Twisted-pair cable 2m (pulse train function)

Note 1. The robot cable is flexible and resists bending. See P.732 for details on robot cable.

Specifications

AC servo motor output (W)	30		
Repeatability ^{Note 1} (mm)	+/-0.02		
Deceleration mechanism	Ball screw $\phi 8$		
Ball screw lead (mm)	12	6	2
Maximum speed (mm/sec)	720	360	120
Maximum payload (kg)	Horizontal		
	4.5	6	6
	Vertical		
	1.2	2.4	7.2
Rated thrust (N)	32	64	153
Stroke (mm)	50 to 400 (50mm pitch)		
Overall length (mm)	Horizontal		
	Stroke+198		
	Vertical		
	Stroke+236		
Maximum dimensions of cross section of main unit (mm)	W45 x H53		
Cable length (m)	Standard: 3.5 / Option: 1.5, 10		
Linear guide type	2 rows of gothic arch grooves x 1 rail		
Position detector	Resolvers ^{Note 2}		
Resolution (Pulse/rotation)	16384		

Note 1. Positioning repeatability in one direction.

Note 2. Position detectors (resolvers) are common to incremental and absolute specifications. If the controller has a backup function then it will be absolute specifications.

Allowable overhang^{Note}

Horizontal installation (Unit: mm)				Wall installation (Unit: mm)				Vertical installation (Unit: mm)						
Lead	Weight	A	B	Lead	Weight	A	B	Lead	Weight	C				
Lead 12	2kg	433	87	180	Lead 12	2kg	149	54	Lead 12	1.2kg	125	125		
	4.5kg	223	33	75		Lead 6	4.5kg	50		1	Lead 6	2.4kg	56	57
	3kg	515	58	135			Lead 2	3kg		107		24	Lead 2	3kg
6kg	340	26	62	Lead 2	6kg			31	0	Lead 2		7.2kg		0
Lead 2	3kg	1585	58		142	Lead 2	3kg	113	24		Lead 2	3kg	41	42
	6kg	755	27	66	Lead 2		6kg	32	0	Lead 2		7.2kg	0	0

Note. Distance from center of slider top to center of gravity of object being carried at a guide service life of 10,000 km.

Note. Service life is calculated for 300mm stroke models.

Static loading moment

(Unit: N·m)		
MY	MP	MR
15	19	18

Controller

Controller	Operation method
ERC	Pulse train control / Programming / I/O point trace / Remote command / Operation using RS-232C communication

T4L

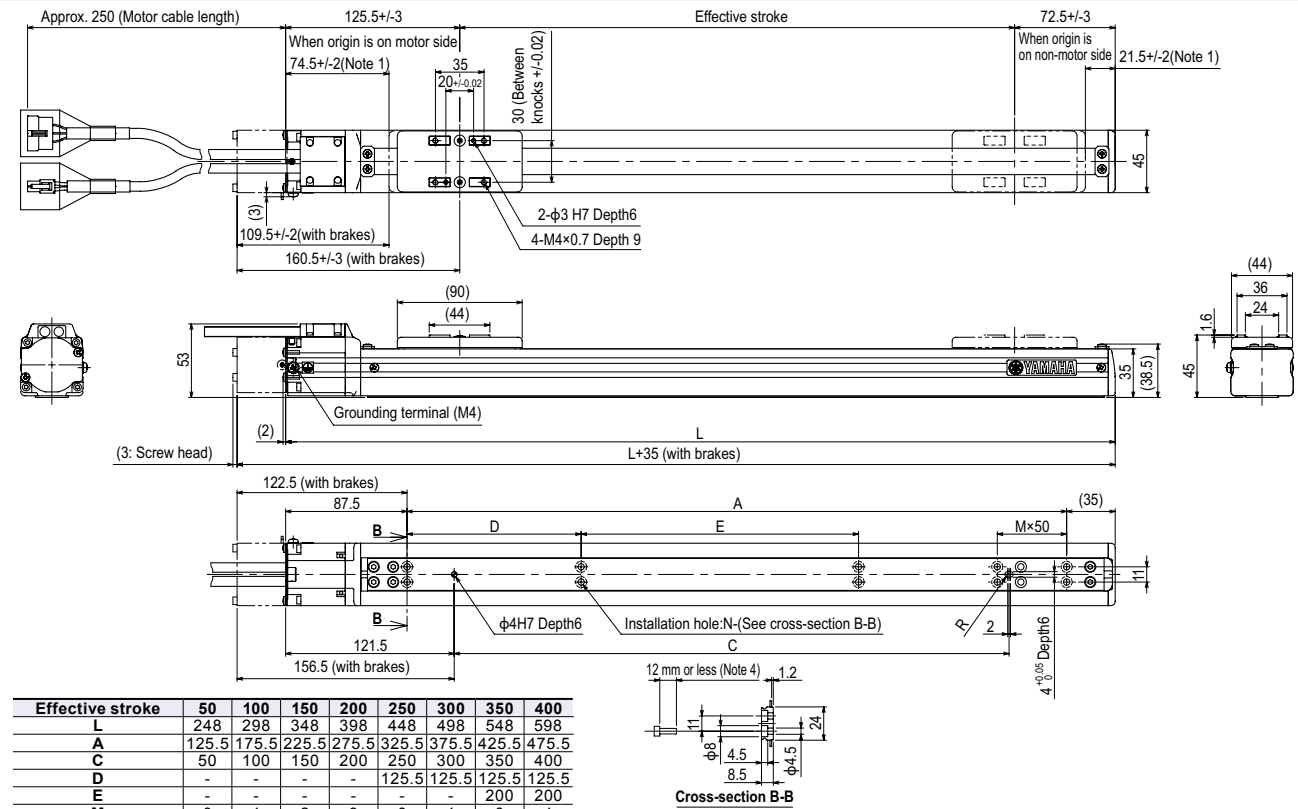

Effective stroke	50	100	150	200	250	300	350	400
L	248	298	348	398	448	498	548	598
A	125.5	175.5	225.5	275.5	325.5	375.5	425.5	475.5
C	50	100	150	200	250	300	350	400
D	-	-	-	-	125.5	125.5	125.5	125.5
E	-	-	-	-	-	200	200	-
M	0	1	2	3	0	1	0	1
N	4	6	8	10	6	8	8	10
Weight (kg) ^{Note 3}	1.1	1.2	1.4	1.5	1.6	1.7	1.8	1.9
Maximum speed for each stroke (mm/sec)	Lead 12	720						
	Lead 6	360						
	Lead 2	120						

Note 1. Stop positions are determined by the mechanical stoppers at both ends.

Note 2. Minimum bend radius of motor cable is R30.

Note 3. Weight of models with no brake. The weight of brake-attached models is 0.2 kg heavier than the models with no brake shown in the table.

Note 4. The under-head length of the hex socket-head bolt (M4x0.7) to be used for the installation work is 12mm or less.

Note 5. External view of T4LH is identical to T4L.

T5L

- High lead: Lead 20
- Origin on the non-motor side is selectable
- Controller: 24V



Ordering method

T5L							ERCD	
Model	Lead designation	Brake ^{Note 1}	Origin position change	Grease type	Stroke	Cable length ^{Note 2}	Controller	I/O connector specification
	20: 20mm 12: 12mm 6: 6mm	No entry: No brakes BK: Brakes provided	None: Standard Z: Non-motor side	None: Standard GC: Clean	50 to 800 (50mm pitch)	1K: 1m 3K: 3.5m 5K: 5m 10K: 10m		CN1: I/O flat cable 1m (Standard) CN2: Twisted-pair cable 2m (pulse train function)

Note 1. The model with a lead of 20mm cannot select specifications with brake (vertical specifications).
Note 2. The robot cable is flexible and resists bending. See P.732 for details on robot cable.

Specifications

AC servo motor output (W)	30
Repeatability ^{Note 1} (mm)	+/-0.02
Deceleration mechanism	Ball screw $\phi 12$
Ball screw lead (mm)	20 12 6
Maximum speed ^{Note 2} (mm/sec)	1200 800 400
Maximum payload (kg)	Horizontal: 3, 5, 9 Vertical: - 1.2 2.4
Rated thrust (N)	19 32 64
Stroke (mm)	50 to 800 (50mm pitch)
Overall length (mm)	Horizontal: Stroke+201.5 Vertical: Stroke+239.5
Maximum dimensions of cross section of main unit (mm)	W55×H52
Cable length (m)	Standard: 3.5 / Option: 1.5, 10
Linear guide type	2 rows of gothic arch grooves × 1 rail
Position detector	Resolvers ^{Note 3}
Resolution (Pulse/rotation)	16384

Note 1. Positioning repeatability in one direction.
Note 2. When the stroke is longer than 600mm, resonance of the ball screw may occur depending on the operation conditions (critical speed). In this case, reduce the speed setting on the program by referring to the maximum speeds shown in the table below.
Note 3. Position detectors (resolvers) are common to incremental and absolute specifications. If the controller has a backup function then it will be absolute specifications.

Allowable overhang^{Note}

	Horizontal installation (Unit: mm)			Wall installation (Unit: mm)			Vertical installation (Unit: mm)		
	A	B	C	A	B	C	A	C	
Lead 20	1kg: 600	3kg: 323	6kg: 683	1kg: 600	3kg: 291	6kg: 600	1.2kg: 242	2.4kg: 240	
Lead 12	2kg: 675	3kg: 103	5kg: 247	2kg: 215	3kg: 73	5kg: 589	1.2kg: 113	2.4kg: 113	
Lead 6	2kg: 1170	3kg: 159	5kg: 406	2kg: 368	3kg: 127	5kg: 1082			
Lead 12	3kg: 555	5kg: 59	9kg: 155	3kg: 127	5kg: 30	9kg: 449			
Lead 6	3kg: 1498	5kg: 104	9kg: 294	3kg: 263	5kg: 73	9kg: 970			
Lead 12	5kg: 628	9kg: 31	9kg: 89	5kg: 54	9kg: 0	9kg: 400			

Note. Distance from center of slider top to center of gravity of object being carried at a guide service life of 10,000 km.
Note. Service life is calculated for 600mm stroke models.

Static loading moment

(Unit: N·m)		
MY	MP	MR
30	34	40

Controller

Controller	Operation method
ERCD	Pulse train control / Programming / I/O point trace / Remote command / Operation using RS-232C communication

T5L

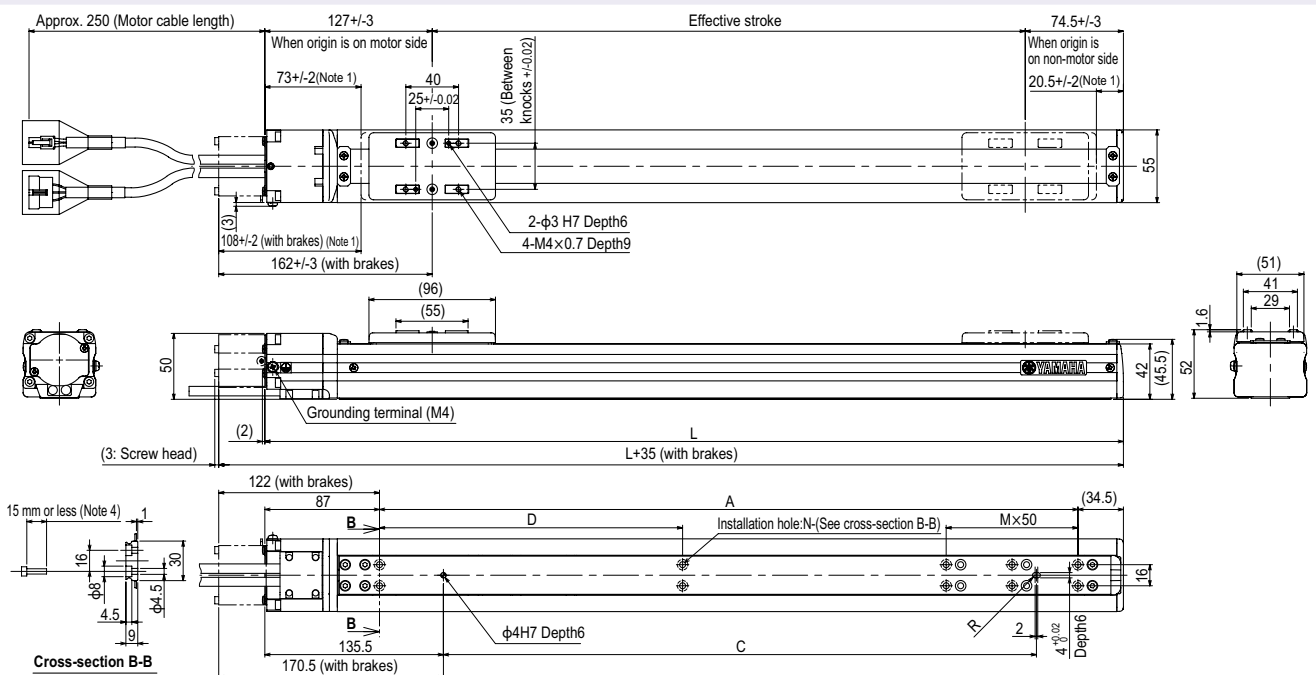

Effective stroke	50	100	150	200	250	300	350	400	450	500	550	600	650	700	750	800	
L	251.5	301.5	351.5	401.5	451.5	501.5	551.5	601.5	651.5	701.5	751.5	801.5	851.5	901.5	951.5	1001.5	
A	130	180	230	280	330	380	430	480	530	580	630	680	730	780	830	880	
C	50	100	150	200	250	300	350	400	450	500	550	600	650	700	750	800	
D	-	-	-	-	-	230	230	230	230	230	230	230	230	230	230	230	
M	0	1	2	3	4	5	0	1	2	3	4	5	6	7	8	9	
N	4	6	8	10	12	14	6	8	10	12	14	16	18	20	22	24	
Weight (kg) ^{Note 3}	1.7	1.8	2.0	2.2	2.3	2.5	2.7	2.8	3.0	3.2	3.3	3.5	3.7	3.8	4.0	4.2	
Maximum speed for each stroke ^{Note 5} (mm/sec)	1200						960						840				
Lead 20	800						640						560				
Lead 6	400						320						280				
Speed setting	-						80%						70%				

Note 1. Stop positions are determined by the mechanical stoppers at both ends.
Note 2. Minimum bend radius of motor cable is R30.
Note 3. Weight of models with no brake. The weight of brake-attached models is 0.2 kg heavier than the models with no brake shown in the table.
Note 4. The under-head length of the hex socket-head bolt (M4×0.7) to be used for the installation work is 15mm or less.
Note 5. When the stroke is longer than 600mm, resonance of the ball screw may occur depending on the operation conditions (critical speed). In this case, reduce the speed setting on the program by referring to the maximum speeds shown in the table at the left.
Note 6. External view of T5LH is identical to T5L.

T5LH

- High lead: Lead 20
- Origin on the non-motor side is selectable
- Controller: 100V / 200V



Ordering method

T5LH	Model	Lead designation 20: 20mm 12: 12mm 6: 6mm	Brake ^{Note 1} No entry: No brakes BK: Brakes provided	Origin position change None: Standard Z: Non-motor side	Grease type None: Standard GC: Clean	Stroke 50 to 800 (50mm pitch)	Cable length ^{Note 2} 3L: 3.5m 5L: 5m 10L: 10m 3K/5K/10K (Flexible cable)	TSX	Positioner ^{Note 3} TSX: TS-X	Driver: Power-supply voltage / Power capacity 105: 100V/100W or less 205: 200V/100W or less	LCD monitor No entry: None L: With LCD	I/O selection NP: NPN PN: PNP CC: CC-Link DN: DeviceNet™ EP: EtherNet/IP™ PT: PROFINET GW: No I/O board ^{Note 4}	Battery B: With battery (Absolute) N: None (Incremental)
								SR1-X	Controller	05 05: 100W or less	Usable for CE No entry: Standard E: CE marking	I/O selection N: NPN P: PNP CC: CC-Link DN: DeviceNet™ PB: PROFIBUS	Battery B: With battery (Absolute) N: None (Incremental)
								RDV-X	Driver	2 2: AC200V	05 05: 100W or less		

- Note 1. The model with a lead of 20mm cannot select specifications with brake (vertical specifications).
 Note 2. The robot cable is standard cable (3L/5L/10L), but can be changed to flexible cable. See P.732 for details on robot cable.
 Note 3. See P.634 for DIN rail mounting bracket.
 Note 4. Select this selection when using the gateway function. For details, see P.96.

Specifications

AC servo motor output (W)	30
Repeatability ^{Note 1} (mm)	+/-0.02
Deceleration mechanism	Ball screw ϕ 12
Ball screw lead (mm)	20 12 6
Maximum speed ^{Note 2} (mm/sec)	1200 800 400
Maximum payload (kg)	Horizontal 3 5 9 Vertical - 1.2 2.4
Rated thrust (N)	19 32 64
Stroke (mm)	50 to 800 (50mm pitch)
Overall length (mm)	Horizontal Stroke+201.5 Vertical Stroke+239.5
Maximum dimensions of cross section of main unit (mm)	W55×H52
Cable length (m)	Standard: 3.5 / Option: 5,10
Linear guide type	2 rows of gothic arch grooves × 1 rail
Position detector	Resolvers ^{Note 3}
Resolution (Pulse/rotation)	16384

- Note 1. Positioning repeatability in one direction.
 Note 2. When the stroke is longer than 600mm, resonance of the ball screw may occur depending on the operation conditions (critical speed). In this case, reduce the speed setting on the program by referring to the maximum speeds shown in the table below.
 Note 3. Position detectors (resolvers) are common to incremental and absolute specifications. If the controller has a backup function then it will be absolute specifications.

Allowable overhang

	Horizontal installation (Unit: mm)				Wall installation (Unit: mm)				Vertical installation (Unit: mm)		
	A	B	C	Stroke	A	B	C	Stroke	Lead 12	A	C
Lead 20	967	324	598	500	551	304	925	600	1.2kg	240	239
Lead 12	429	104	226	400	185	89	378	400	2.4kg	109	110
Lead 6	916	159	398	300	347	141	800	300			
Lead 20	436	60	152	200	119	44	355	200			
Lead 12	1194	105	294	100	3kg	259	87	950			
Lead 6	624	31	89	50	9kg	50	15	385			

Note. Distance from center of slider top to center of gravity of object being carried at a guide service life of 10,000 km.

Note. Service life is calculated for 600mm stroke models.

Static loading moment

(Unit: N·m)		
MY	MP	MR
30	34	40

Controller

Controller	Operation method
SR1-X05	Programming / I/O point trace / Remote command / Operation using RS-232C communication
TS-X105	I/O point trace / Remote command
RDV-X205	Pulse train control

T5LH

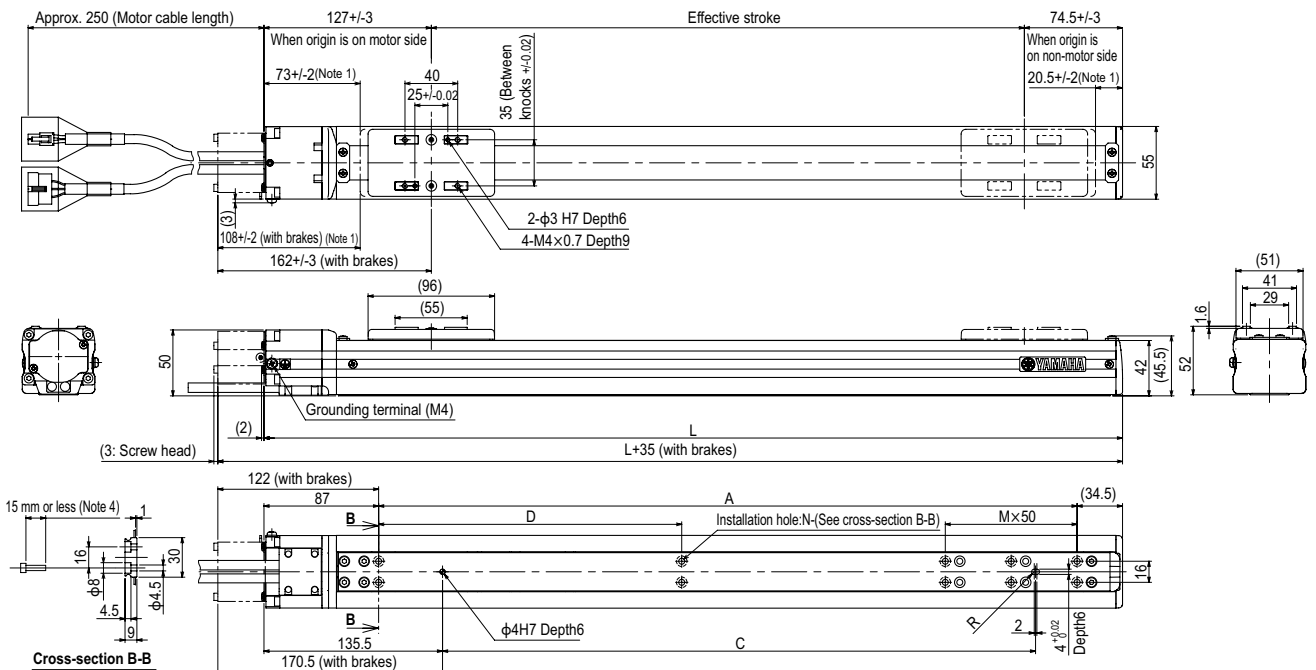

Effective stroke	50	100	150	200	250	300	350	400	450	500	550	600	650	700	750	800
L	251	530	535	541	545	551	560	565	571	575	580	585	591	595	5100	5100
A	130	180	230	280	330	380	430	480	530	580	630	680	730	780	830	880
C	50	100	150	200	250	300	350	400	450	500	550	600	650	700	750	800
D	-	-	-	-	-	230	230	230	230	230	230	230	230	230	230	230
M	0	1	2	3	4	5	6	7	8	9	10	11	12	13	14	15
N	4	6	8	10	12	14	16	18	20	22	24	26	28	30	32	34
Weight (kg) ^{Note 3}	1.7	1.8	2.0	2.2	2.3	2.5	2.7	2.8	3.0	3.2	3.3	3.5	3.7	3.8	4.0	4.2
Maximum speed for each stroke ^{Note 5} (mm/sec)	-															
Speed setting	-															

- Note 1. Stop positions are determined by the mechanical stoppers at both ends.
 Note 2. Minimum bend radius of motor cable is R30.
 Note 3. Weight of models with no brake. The weight of brake-attached models is 0.2 kg heavier than the models with no brake shown in the table.
 Note 4. The under-head length of the hex socket-head bolt (M4×0.7) to be used for the installation work is 15mm or less.
 Note 5. When the stroke is longer than 600mm, resonance of the ball screw may occur depending on the operation conditions (critical speed). In this case, reduce the speed setting on the program by referring to the maximum speeds shown in the table at the left.
 Note 6. External view of T5LH is identical to T5L.

T6L

- High lead: Lead 20
- Origin on the non-motor side is selectable
- Controller: 100V / 200V



Ordering method

T6L

Model	Lead designation	Brake	Origin position change	Grease type	Stroke	Cable length
	20: 20mm 12: 12mm 6: 6mm	No entry: No brakes BK: Brakes provided	None: Standard Z: Non-motor side	None: Standard GC: Clean	50 to 800 (50mm pitch)	3L: 3.5m 5L: 5m 10L: 10m 5K/5K/10K (Flexible cable)

TSX

Positioner	Driver: Power-supply voltage / Power capacity	LCD monitor	I/O selection	Battery
TSX: TS-X	105: 100V/100W or less 205: 200V/100W or less	No entry: None L: With LCD	NP: NPN PN: PNP CC: CC-Link DN: DeviceNet™ EP: EtherNet/IP™ PT: PROFINET GW: No I/O board	B: With battery (Absolute) N: None (Incremental)

SR1-X

Controller	Driver: Power capacity	Usable for CE	I/O selection	Battery
05	05: 100W or less	No entry: Standard E: CE marking	N: NPN P: PNP CC: CC-Link DN: DeviceNet™ PB: PROFIBUS	B: With battery (Absolute) N: None (Incremental)

RDV-X

Driver	Power-supply voltage	Driver: Power capacity	Regenerative unit
2	2: AC200V	05: 100W or less	RBR1

- Note 1. The model with a lead of 20mm cannot select specifications with brake (vertical specifications).
 Note 2. The robot cable is standard cable (3L/5L/10L), but can be changed to flexible cable. See P.732 for details on robot cable.
 Note 3. See P.634 for DIN rail mounting bracket.
 Note 4. Select this selection when using the gateway function. For details, see P.96.

Specifications

AC servo motor output (W)	60
Repeatability (mm)	+/-0.02
Deceleration mechanism	Ball screw $\phi 12$
Ball screw lead (mm)	20 12 6
Maximum speed (mm/sec)	1333 800 400
Maximum payload (kg)	Horizontal: 10 12 30 Vertical: - 4 8
Rated thrust (N)	51 85 170
Stroke (mm)	50 to 800 (50mm pitch)
Overall length (mm)	Horizontal: Stroke+247.5 Vertical: Stroke+285.5
Maximum dimensions of cross section of main unit (mm)	W65×H56
Cable length (m)	Standard: 3.5 / Option: 5,10
Linear guide type	2 rows of gothic arch grooves × 1 rail
Position detector	Resolvers
Resolution (Pulse/rotation)	16384

- Note 1. Positioning repeatability in one direction.
 Note 2. When the stroke is longer than 600mm, resonance of the ball screw may occur depending on the operation conditions (critical speed). In this case, reduce the speed setting on the program by referring to the maximum speeds shown in the table below.
 Note 3. Position detectors (resolvers) are common to incremental and absolute specifications. If the controller has a backup function then it will be absolute specifications.

Allowable overhang

Installation	Horizontal installation (Unit: mm)			Wall installation (Unit: mm)			Vertical installation (Unit: mm)		
	A	B	C	A	B	C	A	B	C
Lead 20	2kg 319	184	234	2kg 234	152	265	1kg 355	352	
Lead 12	6kg 98	37	77	6kg 61	13	71	2kg 165	165	
Lead 6	10kg 64	0	55	10kg 30	0	42	4kg 70	72	
Lead 20	3kg 624	125	335	3kg 293	96	510	2kg 171	172	
Lead 12	8kg 273	41	121	8kg 89	14	210	4kg 73	74	
Lead 6	12kg 216	24	77	12kg 43	0	130	8kg 23	26	
Lead 20	5kg 694	73	236	5kg 204	45	530			
Lead 12	10kg 374	33	109	10kg 72	0	245			
Lead 6	30kg 159	0	25	30kg 0	0	0			

- Note. Distance from center of slider top to center of gravity of object being carried at a guide service life of 10,000 km.
 Note. Service life is calculated for 600mm stroke models.

Static loading moment

Unit: N·m	MY	MP	MR
35	40	50	

Controller

Controller	Operation method
SR1-X05	Programming / I/O point trace
RXC320	Remote command / Operation
RXC221/222	using RS-232C communication
RXC340	
TS-X105	I/O point trace / Remote command
TS-X205	
RDV-X205-RBR1	Pulse train control

T6L

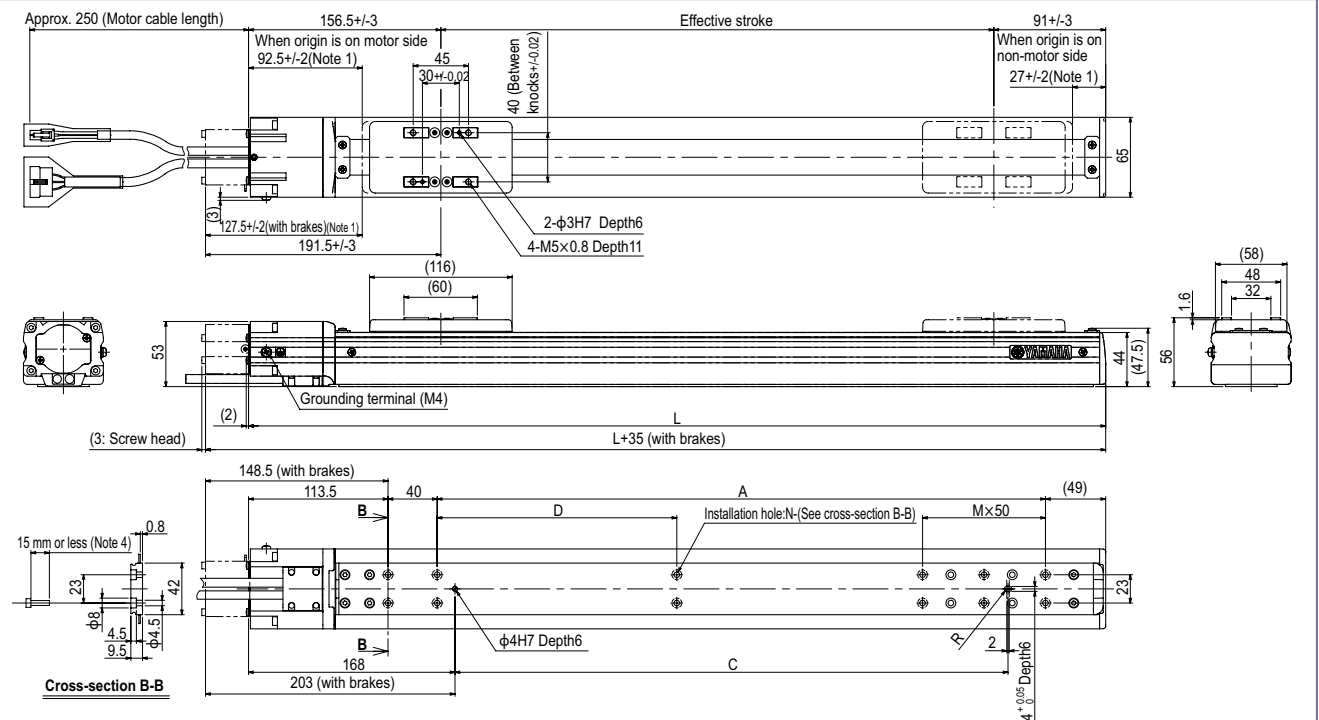

Effective stroke	Stroke (mm)															
	50	100	150	200	250	300	350	400	450	500	550	600	650	700	750	800
L	297.5	347.5	397.5	447.5	497.5	547.5	597.5	647.5	697.5	747.5	797.5	847.5	897.5	947.5	997.5	1047.5
A	95	145	195	245	295	345	395	445	495	545	595	645	695	745	795	845
C	50	100	150	200	250	300	350	400	450	500	550	600	650	700	750	800
D	-	-	-	-	-	-	195	195	195	195	195	195	195	195	195	195
M	0	1	2	3	4	5	0	1	2	3	4	5	6	7	8	9
N	6	8	10	12	14	16	8	10	12	14	16	18	20	22	24	26
Weight (kg)	2.4	2.6	2.8	3.1	3.3	3.5	3.7	4.0	4.2	4.4	4.6	4.8	5.1	5.3	5.5	5.7
Maximum speed for each stroke (mm/sec)	Lead 20	1333														
	Lead 12	800														
	Lead 6	400														
	Speed setting	85% 75% 65% 60%														

- Note 1. Stop positions are determined by the mechanical stoppers at both ends.
 Note 2. Minimum bend radius of motor cable is R30.
 Note 3. Weight of models with no brake. The weight of brake-attached models is 0.2 kg heavier than the models with no brake shown in the table.
 Note 4. The under-head length of the hex socket-head bolt (M4x0.7) to be used for the installation work is 15mm or less.
 Note 5. When the stroke is longer than 600mm, resonance of the ball screw may occur depending on the operation conditions (critical speed). In this case, reduce the speed setting on the program by referring to the maximum speeds shown in the table at the left.

T9H

● High lead: Lead 30

● Origin on the non-motor side is selectable: Lead 20-30

Note. Strokes longer than 1050mm are special order items. Please consult us for delivery time.

Ordering method

T9H					
Model	Lead designation	Brake	Origin position change	Grease type	Stroke
	30: 30mm 20: 20mm 10: 10mm 5: 5mm	No entry/No brakes BK: Brakes provided	None: Standard Z: Non-motor side	None: Standard GC: Clean	Lead 20/10/5: 150 to 1050 (50mm pitch) Lead 30: 150 to 1250 (50mm pitch)
					Cable length
					3L: 3.5m 5L: 5m 10L: 10m 3K/5K/10K (Flexible cable)

TSX				
Positioner	Driver: Power-supply voltage Power capacity	Regenerative unit	LCD monitor	I/O selection
TSX: TS-X	110: 100V/200W 210: 200V/200W	No entry: None R: With RGT	No entry: None L: With LCD	NP: NPN PN: PNP CC: CC-Link DN: DeviceNet™ EP: EtherNet/IP™ PT: PROFINET GW: No I/O board
				Battery B: With battery (Absolute) N: None (Incremental)

SR1-X 10				
Controller	Driver: Power capacity	Usable for CE	Regenerative unit	I/O selection
	10: 200W	No entry: Standard E: CE marking	No entry: None R: With RGT	N: NPN P: PNP CC: CC-Link DN: DeviceNet™ PB: PROFIBUS
				Battery B: With battery (Absolute) N: None (Incremental)

RDV-X 2		10		RBR1	
Driver	Power-supply voltage	Driver: Power capacity	Regenerative unit		
	2: AC200V	10: 200W or less			

- Note 1. The model with a lead of 30mm cannot select specifications with brake (vertical specifications).
 Note 2. If selecting 10mm-5mm lead specifications then the origin point cannot be changed to the non-motor side.
 Note 3. The robot cable is standard cable (3L/5L/10L), but can be changed to flexible cable. See P.732 for details on robot cable.
 Note 4. See P.634 for DIN rail mounting bracket.
 Note 5. Select this selection when using the gateway function. For details, see P.96.

Specifications

AC servo motor output (W)	200		
Repeatability (mm)	±0.01		
Deceleration mechanism	Ball screw φ15		
Ball screw lead (mm)	30	20	10
Maximum speed (mm/sec)	1800	1200	600
Maximum payload (kg)	Horizontal: 25	Vertical: 40	80
Rated thrust (N)	113	170	341
Stroke (mm)	150 to 1250 (50mm pitch)		
Overall length (mm)	Horizontal: Stroke+273 Vertical: Stroke+303		
Maximum dimensions of cross section of main unit (mm)	W94 × H98		
Cable length (m)	Standard: 3.5 / Option: 5.10		
Linear guide type	4 rows of circular arc grooves × 1 rail		
Position detector	Resolvers		
Resolution (Pulse/rotation)	16384		

- Note 1. Positioning repeatability in one direction.
 Note 2. When the stroke is longer than 700mm, resonance of the ball screw may occur depending on the operation conditions (critical speed). In this case, reduce the speed setting on the program by referring to the maximum speeds shown in the table below.
 Note 3. Strokes longer than 1050mm are available only for high lead (Lead 30). (Special order item)
 Note 4. Position detectors (resolvers) are common to incremental and absolute specifications. If the controller has a backup function then it will be absolute specifications.

Allowable overhang

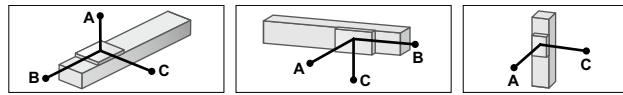

Installation	Lead	Horizontal installation (Unit: mm)			Wall installation (Unit: mm)			Vertical installation (Unit: mm)			
		A	B	C	A	B	C	A	B	C	
Horizontal	Lead 30	10kg: 415	286	183	10kg: 140	120	323	Vertical	4kg: 515	515	
	Lead 20	20kg: 270	105	93	20kg: 41	0	123		6kg: 334	334	
	Lead 10	10kg: 667	244	225	10kg: 170	128	549		8kg: 244	244	
	Lead 5	20kg: 330	112	107	20kg: 46	0	182		10kg: 217	217	
Wall	Lead 30	40kg: 162	42	47	40kg: 0	0	0	15kg: 133	133		
	Lead 20	30kg: 392	75	81	20kg: 52	0	335	20kg: 90	90		
	Lead 10	50kg: 297	40	44	25kg: 24	0	235	15kg: 135	135		
	Lead 5	80kg: 265	21	24	30kg: 0	0	108	20kg: 92	92		
Vertical	Lead 30	60kg: 477	22	37	20kg: 54	0	710	30kg: 49	49		
	Lead 20	80kg: 412	22	25	25kg: 25	0	505				
	Lead 10	100kg: 362	16	18	30kg: 0	0	355				
	Lead 5										

Note. Distance from center of slider top to center of gravity of object being carried at a guide service life of 10,000 km.

Static loading moment

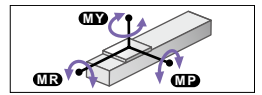

(Unit: N·m)		
MY	MP	MR
86	133	117

Controller

Controller	Operation method
SR1-X10 Note	Programming / I/O point trace / Remote command / Operation using RS-232C communication
RXC320	
RXC221/222	
RCX340	
TS-X110 Note	I/O point trace / Remote command
TS-X210 Note	Pulse train control
RDV-X210-RBR1	

Note. When using the unit vertically, a regeneration unit is required.

T9H

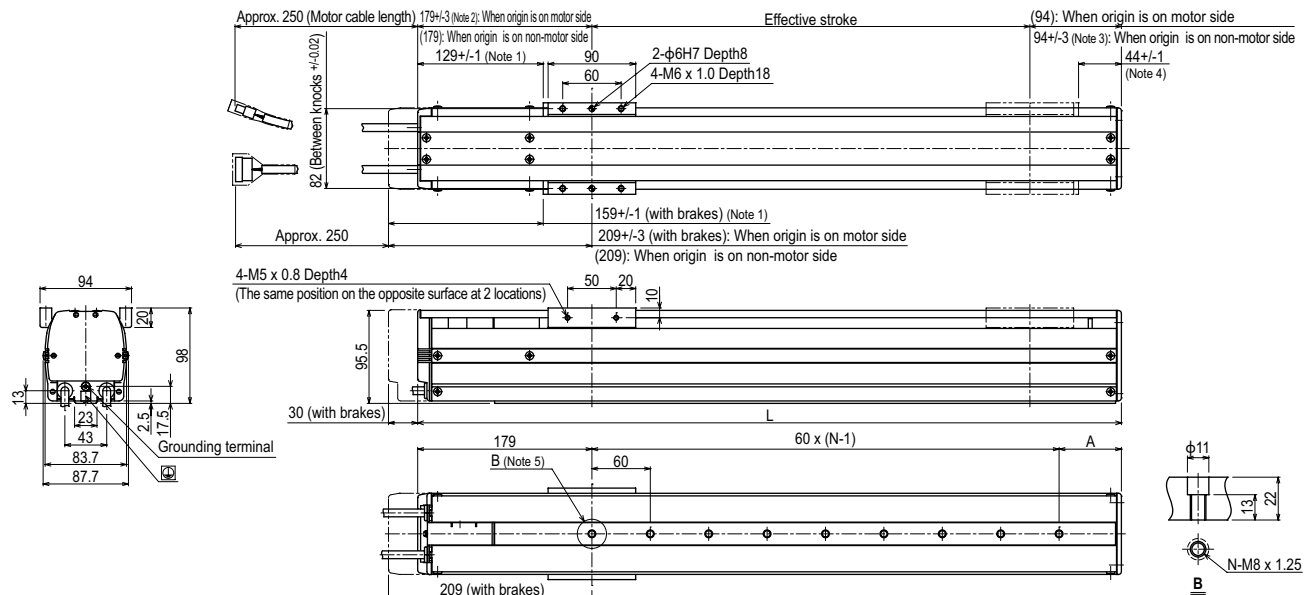

- Note 1. Stop positions are determined by the mechanical stoppers at both ends.
 Note 2. 181.5+/-4 when the high lead specification (Lead 30) is used.
 Note 3. 94+/-4 when the high lead specification (Lead 30) is used.
 Note 4. 41.5+/-1 when the high lead specification (Lead 30) is used.
 Note 5. When installing the unit, washers, etc., cannot be used in the φ11 counter bore hole.
 Note 6. Minimum bend radius of motor cable is R5.
 Note 7. Weight of models with no brake. The weight of brake-attached models is 0.5 kg heavier than the models with no brake shown in the table.

Effective stroke	150	200	250	300	350	400	450	500	550	600	650	700	750	800	850	900	950	1000	1050	1100 ^{Note 9}	1150 ^{Note 9}	1200 ^{Note 9}	1250 ^{Note 9}
	L	423	473	523	573	623	673	723	773	823	873	923	973	1023	1073	1123	1173	1223	1273	1323	1373	1423	1473
A	64	54	44	94	84	74	64	54	44	94	84	74	64	54	44	94	84	74	64	54	44	94	84
N	4	5	6	6	7	8	9	10	11	11	12	13	14	15	16	16	17	18	19	20	21	21	22
Weight (kg) ^{Note 7}	5.8	6.2	6.5	6.9	7.3	7.7	8.0	8.4	8.8	9.1	9.5	9.9	10.2	10.6	11.0	11.4	11.7	12.1	12.5	12.9	13.3	13.7	14.1
Maximum speed (mm/sec) ^{Note 8}	Lead 30	1800															1440	1170	900	810			
	Lead 20	1200															960	780	600	540			
	Lead 10	600															480	390	300	270			
	Lead 5	300															240	195	150	135			
Speed setting	-															80%	65%	50%	45%				

- Note 8. When the stroke is longer than 700mm, resonance of the ball screw may occur depending on the operation conditions (critical speed). In this case, reduce the speed setting on the program by referring to the maximum speeds shown in the table above.
 Note 9. Strokes longer than 1050mm are special order items. Please contact us for speed setting.

F8L High lead type: Lead 30

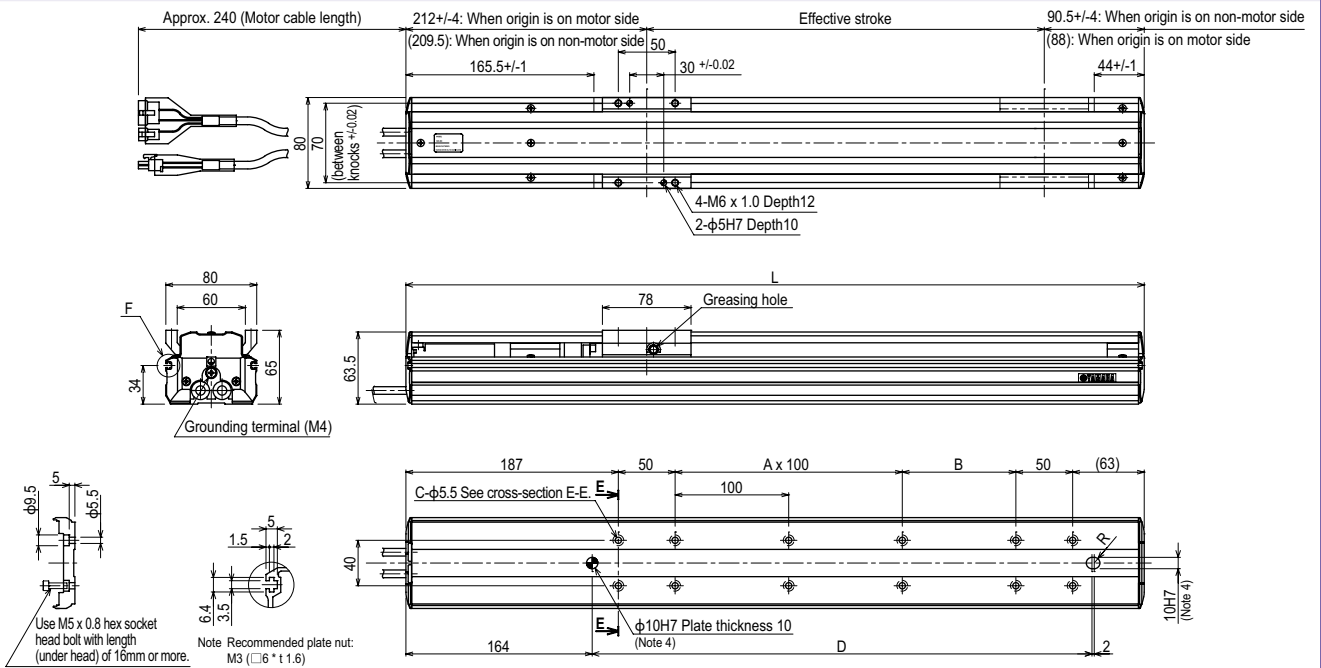

Effective stroke	150	200	250	300	350	400	450	500	550	600	650	700	750	800	850	900	950	1000	1050
L	450	500	550	600	650	700	750	800	850	900	950	1000	1050	1100	1150	1200	1250	1300	1350
A	0	0	1	1	2	2	3	3	4	4	5	5	6	6	7	7	8	8	9
B	100	150	100	150	100	150	100	150	100	150	100	150	100	150	100	150	100	150	100
C	8	8	10	10	12	12	14	14	16	16	18	18	20	20	22	22	24	24	26
D	240	290	340	390	440	490	540	590	640	690	740	790	840	890	940	990	1040	1090	1140
Weight (kg)	3.9	4.2	4.5	4.8	5.1	5.4	5.7	6.1	6.4	6.7	7.0	7.3	7.6	7.9	8.2	8.5	8.8	9.2	9.5
Maximum speed ^{Notes} (mm/sec)	Lead 30	1800										1530	1350	1170	1080	990	900	810	720
	Speed setting	-										85%	75%	65%	60%	55%	50%	45%	40%

Note 1. Stop positions are determined by the mechanical stoppers at both ends.

Note 2. When installing the robot, do not use washers inside the robot body.

Note 3. Minimum bend radius of motor cable is R50.

Note 4. When using this ϕ 10 knockpin hole to position the robot body, the knockpin must not protrude more than 10mm inside the robot body.

Note 5. When the stroke is longer than 650mm, resonance of the ball screw may occur depending on the operation conditions (critical speed). In this case, reduce the speed setting on the program by referring to the maximum speeds shown in the table above.

F10

● High lead: Lead 30

● Origin on the non-motor side is selectable: Lead 10-20-30

Note. Strokes longer than 1050mm are special order items. Please consult us for delivery time.

Ordering method

F10

Model	Lead designation	Brake	Cable entry location	Origin position change	Grease type	Stroke	Cable length
	30: 30mm 20: 20mm 10: 10mm 5: 5mm	No entry: No brakes BK: Brakes provided	No entry: Standard (S) U: From the top	None: Standard Z: Non-motor side	None: Standard GC: Clean	Lead 20/10/5: 150 to 1050 (50mm pitch) Lead 30: 150 to 1250 (50mm pitch)	3L: 3.5m 5L: 5m 10L: 10m 3K/5K/10K (Flexible cable)

- Note 1. The model with a lead of 30mm cannot select specifications with brake (vertical specifications).
 Note 2. If selecting 5mm lead specifications then the origin point cannot be changed to the non-motor side.
 Note 3. The robot cable is standard cable (3L/5L/10L), but can be changed to flexible cable. See P.732 for details on robot cable.
 Note 4. See P.634 for DIN rail mounting bracket.
 Note 5. Select this selection when using the gateway function. For details, see P.96.

TSX

Positioner	Driver: Power-supply voltage	Regenerative unit	LCD monitor	I/O selection	Battery
TSX: TS-X	Power capacity 105: 100V/100W or less 205: 200V/100W or less	No entry: None R: With RGT	No entry: None L: With LCD	NP: NPN PN: PNP CC: CC-Link DN: DeviceNet™ EP: EtherNet/IP™ PT: PROFINET GW: No I/O board	B: With battery (Absolute) N: None (Incremental)

SR1-X

Controller	Driver: Power capacity	Usable for CE	Regenerative unit	I/O selection	Battery
05	05: 100W or less	No entry: Standard E: CE marking	No entry: None R: With RGT	N: NPN P: PNP CC: CC-Link DN: DeviceNet™ PB: PROFIBUS	B: With battery (Absolute) N: None (Incremental)

RDV-X

Driver	Power-supply voltage	Driver: Power capacity	Regenerative unit
2	2: AC200V	05: 100W or less	

Specifications

AC servo motor output (W)	100
Repeatability (mm)	+/-0.01
Deceleration mechanism	Ball screw φ15
Ball screw lead (mm)	30 20 10 5
Maximum speed (mm/sec)	1800 1200 600 300
Maximum payload (kg)	Horizontal: 15 20 40 60 Vertical: - 4 10 20
Rated thrust (N)	56 84 169 339
Stroke (mm)	150 to 1250 (50mm pitch)
Overall length (mm)	Horizontal: Stroke+260 Vertical: Stroke+290
Maximum dimensions of cross section of main unit (mm)	W110 × H71
Cable length (m)	Standard: 3.5 / Option: 5.10
Linear guide type	4 rows of circular arc grooves × 1 rail
Position detector	Resolvers
Resolution (Pulse/rotation)	16384

- Note 1. Positioning repeatability in one direction.
 Note 2. When the stroke is longer than 700mm, resonance of the ball screw may occur depending on the operation conditions (critical speed). In this case, reduce the speed setting on the program by referring to the maximum speeds shown in the table below.
 Note 3. Strokes longer than 1050mm are available only for high lead (Lead 30). (Special order item)
 Note 4. Position detectors (resolvers) are common to incremental and absolute specifications. If the controller has a backup function then it will be absolute specifications.

Allowable overhang

Lead	Horizontal installation (Unit: mm)			Wall installation (Unit: mm)			Vertical installation (Unit: mm)		
	A	B	C	A	B	C	A	B	C
Lead 30	5kg 491	273	215	5kg 206	209	480	1kg 600	600	600
Lead 20	15kg 223	61	63	15kg 45	0	177	2kg 649	691	
	5kg 937	282	259	5kg 250	213	905	4kg 306	347	
Lead 10	10kg 487	121	116	10kg 99	51	438	8kg 142	183	
	20kg 236	40	44	20kg 21	0	149	10kg 102	144	
Lead 5	15kg 389	71	74	10kg 105	53	550	15kg 51	93	
	30kg 179	17	20	20kg 22	0	230	10kg 105	146	
Lead 5	40kg 106	0	0	30kg 0	0	0	15kg 51	93	
	30kg 419	19	20	10kg 107	54	1410	20kg 25	66	
Lead 5	50kg 0	0	0	20kg 22	0	540			
	60kg 0	0	0	30kg 0	0	0			

Note. Distance from center of slider top to center of gravity of object being carried at a guide service life of 10,000 km.

Static loading moment

	(Unit: N·m)		
	MY	MP	MR
	131	131	115

Controller

Controller	Operation method
SR1-X05 Note 5	Programming / I/O point trace / Remote command / Operation using RS-232C communication
RCX320	
RCX221/222	
RCX340	
TS-X105 Note 5	I/O point trace / Remote command
TS-X205 Note 5	
RDV-X205-RBR1	Pulse train control

Note. Regenerative unit is required when the models used vertically and with 700mm or larger stroke.

F10

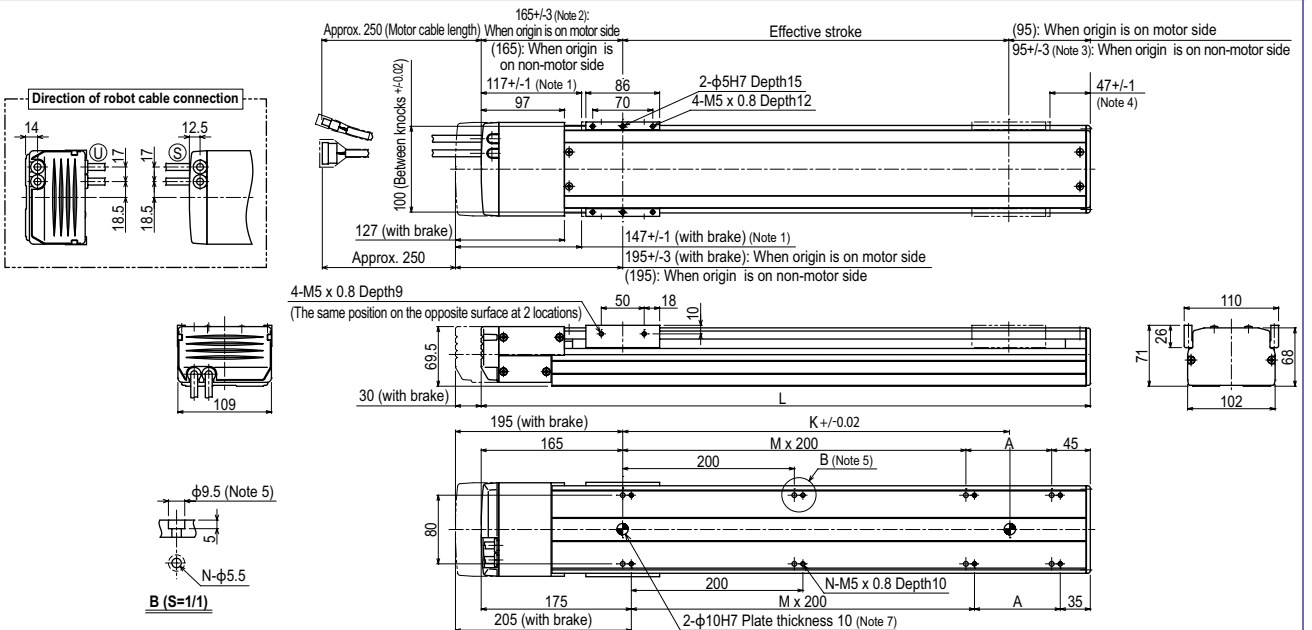

- Note 1. Stop positions are determined by the mechanical stoppers at both ends.
 Note 2. 167.5+/-4 when the high lead specification (Lead 30) is used.
 Note 3. 95+/-4 when the high lead specification (Lead 30) is used.
 Note 4. 44.5+/-1 when the high lead specification (Lead 30) is used.
 Note 5. When installing the unit, washers, etc., cannot be used in the φ9.5 counter bore hole.
 Note 6. Minimum bend radius of motor cable is R50.
 Note 7. When using this φ10 knock-pin hole to position the robot body, the knock-pin must not protrude more than 10mm inside the robot body.
 Note 8. Weight of models with no brake. The weight of brake-attached models is 0.6 kg heavier than the models with no brake shown in the table.

Effective stroke	150	200	250	300	350	400	450	500	550	600	650	700	750	800	850	900	950	1000	1050	1100	1150	1200	1250
	L	410	460	510	560	610	660	710	760	810	860	910	960	1010	1060	1110	1160	1210	1260	1310	1360	1410	1460
A	200	50	100	150	200	50	100	150	200	50	100	150	200	50	100	150	200	50	100	150	200	50	100
M	0	1	1	1	1	2	2	2	2	3	3	3	3	4	4	4	4	5	5	5	5	6	6
N	4	6	6	6	6	8	8	8	8	10	10	10	10	12	12	12	12	14	14	14	14	16	16
K	150	200	250	300	350	400	450	500	550	600	650	700	750	800	850	900	950	1000	1050	1100	1150	1200	1250
Weight (kg)	5.5	5.7	5.8	6.2	6.5	6.9	7.3	7.7	8.1	8.5	8.8	9.2	9.6	10.0	10.4	10.8	11.1	11.5	11.9	12.3	12.7	13.1	13.5
Maximum speed (mm/sec)	Lead 30	1800																					
	Lead 20	1200																					
	Lead 10	600																					
	Lead 5	300																					
Speed setting		80%																					
		65%																					
	50%																						
	45%																						

- Note 9. When the stroke is longer than 700mm, resonance of the ball screw may occur depending on the operation conditions (critical speed). In this case, reduce the speed setting on the program by referring to the maximum speeds shown in the table above.
 Note 10. Strokes longer than 1050mm are special order items. Please contact us for speed setting.

F10H

● High lead: Lead 30

● Origin on the non-motor side is selectable: Lead 10-20-30

Ordering method

F10H

Model	Lead designation	Brake	Cable entry location	Origin position change	Grease type	Stroke	Cable length
	30: 30mm 20: 20mm 10: 10mm 5: 5mm	No entry: No brakes BK: Brakes provided	No entry: Standard (S) U: From the top	None: Standard Z: Non-motor side	None: Standard GC: Clean	Lead 20-10-5: 150 to 1000 (50mm pitch) Lead 30: 150 to 1000 (50mm pitch)	3L: 3.5m 5L: 5m 10L: 10m 3K/5K/10K (Flexible cable)

TSX

Positioner	Driver: Power-supply voltage / Power capacity	Regenerative unit	LCD monitor	I/O selection	Battery
TSX: TS-X	110: 100V/200W 210: 200V/200W	No entry: None R: With RGT	No entry: None L: With LCD	N: NPN P: PNP CC: CC-Link DN: DeviceNet™ EP: EtherNet/IP™ PT: PROFINET GW: No I/O board	B: With battery (Absolute) N: None (Incremental)

SR1-X

Controller	Driver: Power capacity	Usable for CE	Regenerative unit	I/O selection	Battery
SR1-X 10	10: 200W	No entry: Standard E: CE marking	No entry: None R: With RGT	N: NPN P: PNP CC: CC-Link DN: DeviceNet™ PB: Profibus	B: With battery (Absolute) N: None (Incremental)

RDV-X

Driver	Power-supply voltage	Driver: Power capacity	Regenerative unit
RDV-X 2	2: AC200V	10: 200W or less	

- Note 1. The model with a lead of 30mm cannot select specifications with brake (vertical specifications).
 Note 2. If selecting 5mm lead specifications then the origin point cannot be changed to the non-motor side.
 Note 3. The robot cable is standard cable (3L/5L/10L), but can be changed to flexible cable. See P.732 for details on robot cable.
 Note 4. See P.634 for DIN rail mounting bracket.
 Note 5. Select this selection when using the gateway function. For details, see P.96.

Specifications

AC servo motor output (W)	200
Repeatability (mm)	+/- 0.01
Deceleration mechanism	Ball screw φ15
Ball screw lead (mm)	30 20 10 5
Maximum speed (mm/sec)	1800 1200 600 300
Maximum payload (kg)	Horizontal: 25 40 80 100 Vertical: - 8 20 30
Rated thrust (N)	113 170 341 683
Stroke (mm)	150 to 1000
Overall length (mm)	Horizontal: Stroke+355 Vertical: Stroke+385
Maximum dimensions of cross section of main unit (mm)	W110 x H71
Cable length (m)	Standard: 3.5 / Option: 5.10
Linear guide type	4 rows of circular arc grooves x 1 rail
Position detector	Resolvers
Resolution (Pulse/rotation)	16384

- Note 1. Positioning repeatability in one direction.
 Note 2. When the stroke is longer than 600mm, resonance of the ball screw may occur depending on the operation conditions (critical speed). In this case, reduce the speed setting on the program by referring to the maximum speeds shown in the table below. When the movement distance is short, the speed may not reach the maximum speed according to the payload.
 Note 3. Position detectors (resolvers) are common to incremental and absolute specifications. If the controller has a backup function then it will be absolute specifications.

Allowable overhang

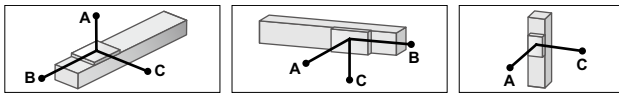

Installation	Horizontal installation (Unit: mm)			Wall installation (Unit: mm)			Vertical installation (Unit: mm)		
	A	B	C	A	B	C	A	C	
Lead 30	1181	681	219	193	570	1062	4kg	1650	
Lead 20	772	298	99	65	187	549	6kg	1104	
Lead 10	1961	685	232	198	570	1786	8kg	832	
Lead 5	949	301	103	65	187	732	10kg	927	
Lead 30	432	109	38	0	0	0	15kg	614	
Lead 20	1615	239	84	100	283	1981	20kg	458	
Lead 10	1131	112	39	66	187	1546	15kg	752	
Lead 5	812	40	14	30kg	43	1233	20kg	560	
Lead 30	3091	112	39	20kg	134	7629	30kg	369	
Lead 20	2330	64	23	25kg	93	264	5987		
Lead 10	1733	36	12	30kg	66	187	4841		

- Note. Distance from center of slider top to center of gravity of object being carried at a guide service life of 10,000 km.
 Note. Service life is calculated for 600mm stroke models.

Static loading moment

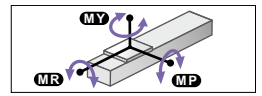

Direction	MY	MP	MR
(Unit: N·m)	348	348	160

Controller

Controller	Operation method
SR1-X10	Programming / I/O point trace / Remote command / Operation using RS-232C communication
RCX320	
RXC221/222	
RCX340	
TS-X110	I/O point trace / Remote command
TS-X210	
RDV-X210-RBR1	Pulse train control

- Note. When using the unit vertically, a regeneration unit is required.

F10H

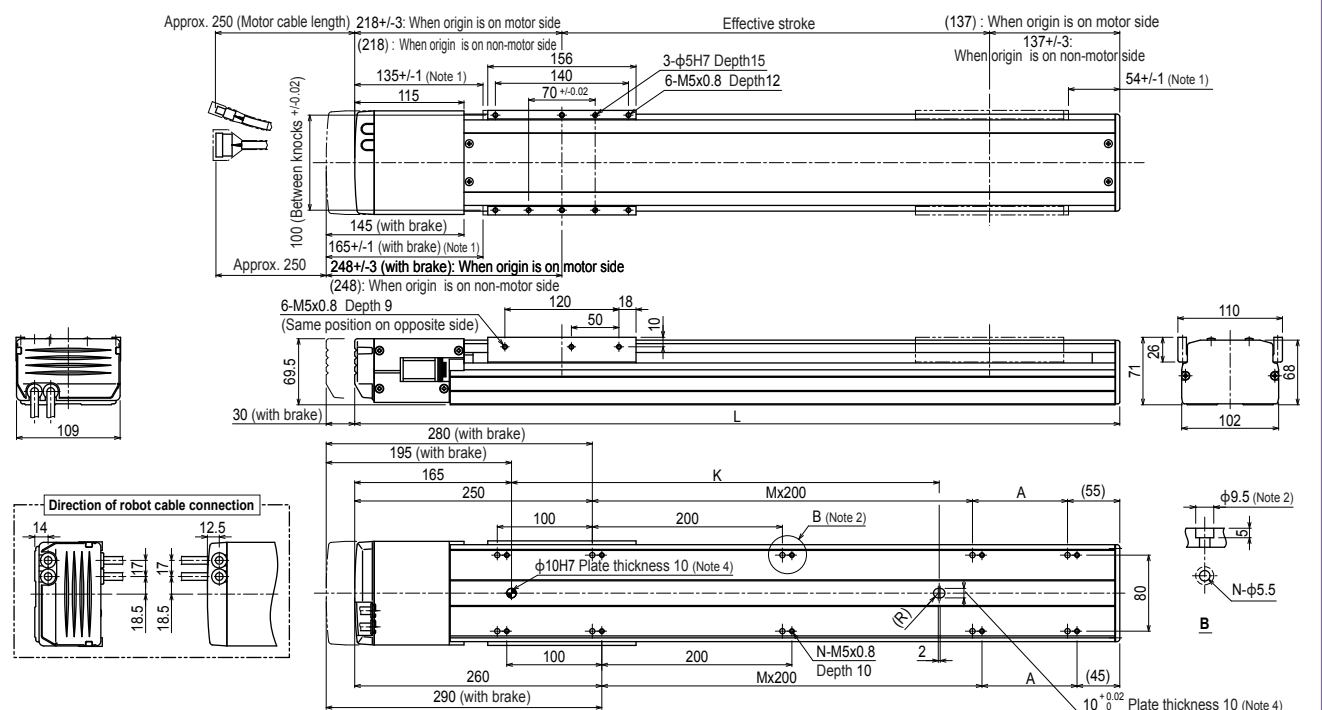

Effective stroke	150	200	250	300	350	400	450	500	550	600	650	700	750	800	850	900	950	1000
L	505	555	605	655	705	755	805	855	905	955	1005	1055	1105	1155	1205	1255	1305	1355
A	200	50	100	150	200	50	100	150	200	50	100	150	200	50	100	150	200	50
M	0	1	1	1	1	2	2	2	2	3	3	3	3	4	4	4	4	5
N	6	8	8	8	8	10	10	10	10	12	12	12	12	14	14	14	14	16
K	250	300	350	400	450	500	550	600	650	700	750	800	850	900	950	1000	1050	1100
Weight (kg)	6.9	7.3	7.7	8.1	8.4	8.8	9.2	9.6	10.0	10.3	10.7	11.1	11.5	11.9	12.2	12.6	13.0	13.4
Maximum speed (mm/sec)	1800	1200	600	300	-	-	-	-	-	-	1440	1260	1080	900	720	630	480	420
Speed setting	80%	70%	60%	50%	40%	35%	-	-	-	-	-	-	-	-	-	-	-	-

- Note 1. Stop positions are determined by the mechanical stoppers at both ends. When installing the unit, washers, etc. cannot be used in the φ9.5 counter bore hole.
 Note 2. Minimum bend radius of motor cable is R50.
 Note 3. When using this φ10 knock-pin hole to position the robot body, the knockpin must not protrude more than 10mm inside the robot body.
 Note 4. Weight of models with no brake. The weight of brake-attached models is 0.5 kg heavier than the models with no brake shown in the table.

Note 6. When the stroke is longer than 600mm, resonance of the ball screw may occur depending on the operation conditions (critical speed). In this case, reduce the speed setting on the program by referring to the maximum speeds shown in the table above.

- Articulated robots **YA**
- Linear conveyor modules **LCM**
- Single-axis robots **CX**
- Motor-less single axis actuator **Robomity**
- Compact single-axis robots **TRANSERO**
- Single-axis robots **FLIP-X**
- Linear motor single-axis robots **PHASER**
- Cartesian robots **XY-X**
- SCARA robots **YK-X**
- Pick & place robots **YP-X**
- CLEAN
- CONTROLLER INFORMATION
- T type
- F type
- GF type
- N type
- BR type

F10H High lead type: Lead 30

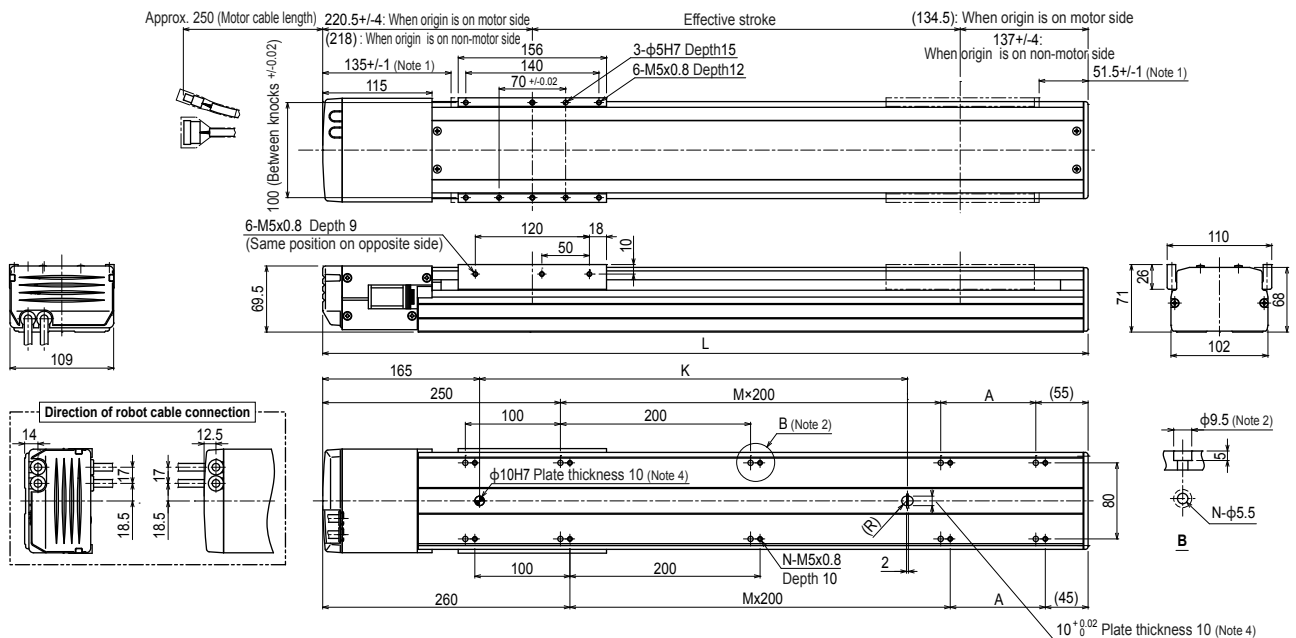

Effective stroke	150	200	250	300	350	400	450	500	550	600	650	700	750	800	850	900	950	1000
L	505	555	605	655	705	755	805	855	905	955	1005	1055	1105	1155	1205	1255	1305	1355
A	200	50	100	150	200	50	100	150	200	50	100	150	200	50	100	150	200	50
M	0	1	1	1	1	2	2	2	3	3	3	3	3	4	4	4	4	5
N	6	8	8	8	8	10	10	10	10	12	12	12	12	14	14	14	14	16
K	250	300	350	400	450	500	550	600	650	700	750	800	850	900	950	1000	1050	1100
Weight (kg)	6.9	7.3	7.7	8.1	8.4	8.8	9.2	9.6	10.0	10.3	10.7	11.1	11.5	11.9	12.2	12.6	13.0	13.4
Maximum speed (mm/sec) <small>Note 5</small>	Lead 30											1440	1260	1080	900	720	630	
	Lead 20											960	840	720	600	480	420	
	Lead 10											480	420	360	300	240	210	
	Lead 5											240	210	180	150	120	105	
	Speed setting											80%	70%	60%	50%	40%	35%	

Note 1. Stop positions are determined by the mechanical stoppers at both ends.
 Note 2. When installing the unit, washers, etc., cannot be used in the φ9.5 counter bore hole.
 Note 3. Minimum bend radius of motor cable is R50.
 Note 4. When using this φ10 knock-pin hole to position the robot body, the knockpin must not protrude more than 10mm inside the robot body.
 Note 5. When the stroke is longer than 600mm, resonance of the ball screw may occur depending on the operation conditions (critical speed). In this case, reduce the speed setting on the program by referring to the maximum speeds shown in the table above.

F14H

● High lead: Lead 30

● Origin on the non-motor side is selectable: Lead 10-20-30

Note. Strokes longer than 1050mm are special order items. Please consult us for delivery time.

Ordering method

F14H

Model	Lead designation	Brake	Cable entry location	Origin position change	Grease type	Stroke	Cable length
	30: 30mm 20: 20mm 10: 10mm 5: 5mm	No entry: No brakes BK: Brakes provided	No entry: Location: Standard (S) U: From the top R: From the right L: From the left	None: Standard Z: Non-motor side	None: Standard GC: Clean	Lead 20/10/5: 150 to 1050 (50mm pitch) Lead 30: 150 to 1250 (50mm pitch)	3L: 3.5m 5L: 5m 10L: 10m 3K/5K/10K (Flexible cable)

- Note 1. The model with a lead of 30mm cannot select specifications with brake (vertical specifications).
 Note 2. If selecting 5mm lead specifications then the origin point cannot be changed to the non-motor side.
 Note 3. The robot cable is standard cable (3L/5L/10L), but can be changed to flexible cable. See P.732 for details on robot cable.
 Note 4. See P.634 for DIN rail mounting bracket.
 Note 5. Select this selection when using the gateway function. For details, see P.96.

TSX

Positioner	Driver: Power-supply voltage	Regenerative unit	LCD monitor	I/O selection	Battery
TSX: TS-X	Power capacity 110: 100V/200W 210: 200V/200W	No entry: None R: With RGT	No entry: None L: With LCD	NP: NPN PN: PNP CC: CC-Link DN: DeviceNet™ EP: EtherNet/IP™ PT: PROFINET GW: No I/O board	B: With battery (Absolute) N: None (Incremental)

SR1-X

Controller	Driver: Power capacity	Usable for CE	Regenerative unit	I/O selection	Battery
10	10: 200W	No entry: Standard E: CE marking	No entry: None R: With RGT	N: NPN P: PNP CC: CC-Link DN: DeviceNet™ PB: PROFIBUS	B: With battery (Absolute) N: None (Incremental)

RDV-X

Driver	Power-supply voltage	Driver: Power capacity	Regenerative unit
2	2: AC200V	10: 200W or less	

Specifications

AC servo motor output (W)	200	
Repeatability (mm)	+/-0.01	
Deceleration mechanism	Ball screw φ15	
Ball screw lead (mm)	30	20 10 5
Maximum speed (mm/sec)	1800	1200 600 300
Maximum payload (kg)	Horizontal	Vertical
	25 40 80 100	- 8 20 30
Rated thrust (N)	113	170 341 683
Stroke (mm)	150 to 1250 (50mm pitch)	
Overall length (mm)	Horizontal	Vertical
	Stroke+320	Stroke+350
Maximum dimensions of cross section of main unit (mm)	W136 × H83	
Cable length (m)	Standard: 3.5 / Option: 5.10	
Linear guide type	4 rows of circular arc grooves × 2 rail	
Position detector	Resolvers	
Resolution (Pulse/rotation)	16384	

- Note 1. Positioning repeatability in one direction.
 Note 2. When the stroke is longer than 700mm, resonance of the ball screw may occur depending on the operation conditions (critical speed). In this case, reduce the speed setting on the program by referring to the maximum speeds shown in the table below.
 Note 3. Strokes longer than 1050mm are available only for high lead (Lead 30). (Special order item)
 Note 4. Position detectors (resolvers) are common to incremental and absolute specifications. If the controller has a backup function then it will be absolute specifications.

Allowable overhang

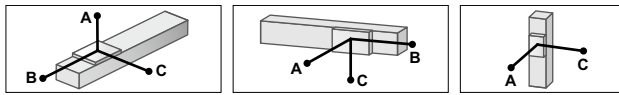

Lead	Horizontal installation (Unit: mm)			Wall installation (Unit: mm)			Vertical installation (Unit: mm)		
	A	B	C	A	B	C	A	B	C
Lead 30	10kg 2152	1673	934	10kg 975	1219	1625	4kg 2400	2016	
	25kg 1847	691	533	25kg 482	426	1257	6kg 1699	1364	
Lead 20	10kg 2265	1674	961	10kg 999	1220	1711	8kg 1301	1051	
	20kg 1402	855	537	20kg 515	558	987	10kg 1370	1106	
Lead 10	40kg 1047	445	324	40kg 263	227	635	15kg 906	732	
	30kg 1953	583	485	30kg 419	338	1282	20kg 678	548	
	50kg 1655	365	328	50kg 240	162	934	20kg 767	619	
	80kg 1720	242	238	80kg 134	62	756	25kg 612	494	
Lead 5	60kg 2443	311	317	60kg 209	117	1398	30kg 503	407	
	80kg 2193	242	253	80kg 135	62	1120			
	100kg 2000	202	214	100kg 90	29	900			

Note. Distance from center of slider top to center of gravity of object being carried at a guide service life of 10,000 km.

Static loading moment

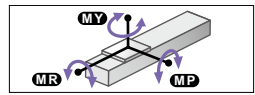

(Unit: N·m)		
MY	MP	MR
551	552	485

Controller

Controller	Operation method
SR1-X10 Note	Programming / I/O point trace / Remote command / Operation using RS-232C communication
RX320	
RCX221/222	
RCX340	
TS-X110 Note	I/O point trace / Remote command
TS-X210 Note	
RDV-X210-RBR1	Pulse train control

Note. When using the unit vertically, a regeneration unit is required.

F14H

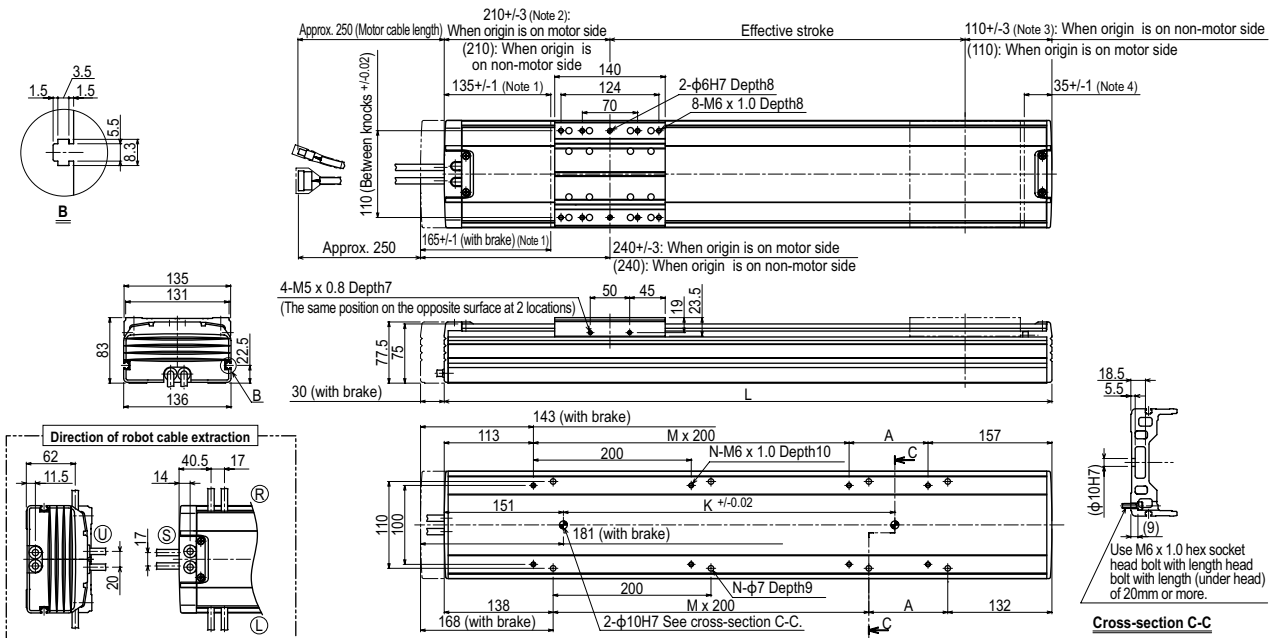

Note 1. Stop positions are determined by the mechanical stoppers at both ends.
 Note 2. 212.5+/-4 when the high lead specification (Lead 30) is used.
 Note 3. 110+/-4 when the high lead specification (Lead 30) is used.
 Note 4. 32.5+/-1 when the high lead specification (Lead 30) is used.
 Note 5. Minimum bend radius of motor cable is R50.
 Note 6. Weight of models with no brake. The weight of brake-attached models is 0.7 kg heavier than the models with no brake shown in the table.

Effective stroke	Lead 30												Lead 20				Lead 10				Lead 5			
	150	200	250	300	350	400	450	500	550	600	650	700	750	800	850	900	950	1000	1050	1100	1150	1200	1250	
L	470	520	570	620	670	720	770	820	870	920	970	1020	1070	1120	1170	1220	1270	1320	1370	1420	1470	1520	1570	
A	200	50	100	150	200	50	100	150	200	50	100	150	200	50	100	150	200	50	100	150	200	50	100	
M	0	1	1	1	1	2	2	2	2	3	3	3	3	4	4	4	5	5	5	5	5	6	6	
N	4	6	6	6	6	8	8	8	8	10	10	10	12	12	12	12	14	14	14	14	14	16	16	
K	240	240	240	420	420	420	600	600	600	600	600	780	780	960	960	960	960	1140	1140	1140	1140	1320	1320	
Weight (kg)	7.5	8.2	8.8	9.5	10.1	10.8	11.4	12.1	12.7	13.4	13.9	14.6	15.2	15.9	16.5	17.2	17.8	18.5	19.1	19.8	20.4	21.1	21.7	
Maximum speed (mm/sec)	1800												1200				600				300			
Speed setting	80%												65%				50%				45%			

Note 7. When the stroke is longer than 700mm, resonance of the ball screw may occur depending on the operation conditions (critical speed). In this case, reduce the speed setting on the program by referring to the maximum speeds shown in the table above.
 Note 8. Strokes longer than 1050mm are special order items. Please contact us for speed setting.

GF14XL

● Origin on the non-motor side is selectable

Note. If you need an installation posture other than the horizontal installation, please contact us.

Ordering method

GF14XL - S H - 20

Model	Model S: Straight model	Installation direction H: Horizontal installation	Lead designation	Cable entry location No entry: Standard (S) U: From the top R: From the right L: From the left	Origin position change None: Standard Z: Non-motor side	Frame No entry: Standard Spot facing T: Tapping	Grease type None: Standard GC: Clean	Stroke 750 to 2000 (50mm pitch)	Cable length 3L: 3.5m 5L: 5m 10L: 10m 3K/5K/10K (Flexible cable)
-------	-------------------------	---	------------------	--	---	--	--	------------------------------------	--

TSX	SR1-X	RDV-X	TSX	SR1-X	RDV-X
Positioning TSX: TS-X	Driver: Power supply voltage 110: 100V/200W 210: 200V/200W	Driver: Power capacity 10: 200W	Positioning TSX: TS-X	Driver: Power capacity 10: 200W	Driver: Power supply voltage 2: AC200V
	LCD monitor No entry: None L: With LCD	Usable for CE No entry: Standard E: CE marking		Usable for CE No entry: Standard E: CE marking	
	I/O selection NP: NPN PN: PNP CC: CC-Link DN: DeviceNet™ EP: EtherNet/IP™ PT: PROFINET GW: No I/O board	I/O selection N: NPN P: PNP CC: CC-Link DN: DeviceNet™ PB: PROFIBUS		I/O selection N: NPN P: PNP CC: CC-Link DN: DeviceNet™ PB: PROFIBUS	
	Battery B: With battery (Absolute) N: None (Incremental)	Battery B: With battery (Absolute) N: None (Incremental)		Battery B: With battery (Absolute) N: None (Incremental)	

Note 1. The robot cable is standard cable (3L/5L/10L), but can be changed to flexible cable. See P.732 for details on robot cable.
 Note 2. See P.634 for DIN rail mounting bracket.
 Note 3. Select this selection when using the gateway function. For details, see P.96.

- [Cautions after purchase]
- When changing the origin position, contact us since the adjustment is needed.
 - When changing the cable entry location, contact us since necessary parts may vary depending on the cable entry location.
 - Do not install the robot with the horizontal installation specifications in a direction other than the horizontal direction.

Specifications

AC servo motor output (W)	200
Repeatability ^{Note 1} (mm)	+/-0.01
Deceleration mechanism	Ball screw φ15
Ball screw lead (mm)	20
Maximum speed (mm/sec)	1200
Maximum payload (kg)	45
Rated thrust (N)	170
Stroke (mm)	750 to 2000 (50mm pitch)
Overall length (mm)	Stroke+561
Maximum dimensions of cross section of main unit (mm)	W140×H91.5
Cable length (m)	Standard: 3.5 / Option: 5.10
Linear guide type	4 rows of circular arc grooves × 2 rail
Position detector	Resolvers ^{Note 2}
Resolution (Pulse/rotation)	20480

Note 1. Positioning repeatability in one direction.
 Note 2. Position detectors (resolvers) are common to incremental and absolute specifications. If the controller has a backup function then it will be absolute specifications.

Allowable overhang^{Note}

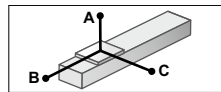

Horizontal installation (Unit: mm)			
	A	B	C
10kg	3550	1340	1210
20kg	2075	685	633
45kg	1280	326	308

Note. Distance from center of slider top to center of gravity of object being carried at a guide service life of 10,000 km.
 Note. Service life is calculated for 1000mm stroke models.

Static loading moment

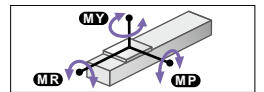

(Unit: N·m)		
MY	MP	MR
551	552	485

Controller

Controller	Operation method
SR1-X10 RCX320 RCX221/222 RCX340	Programming / I/O point trace / Remote command / Operation using RS-232C communication
TS-X110 TS-X210	I/O point trace / Remote command
RDV-X220-RBR1	Pulse train control

GF14XL

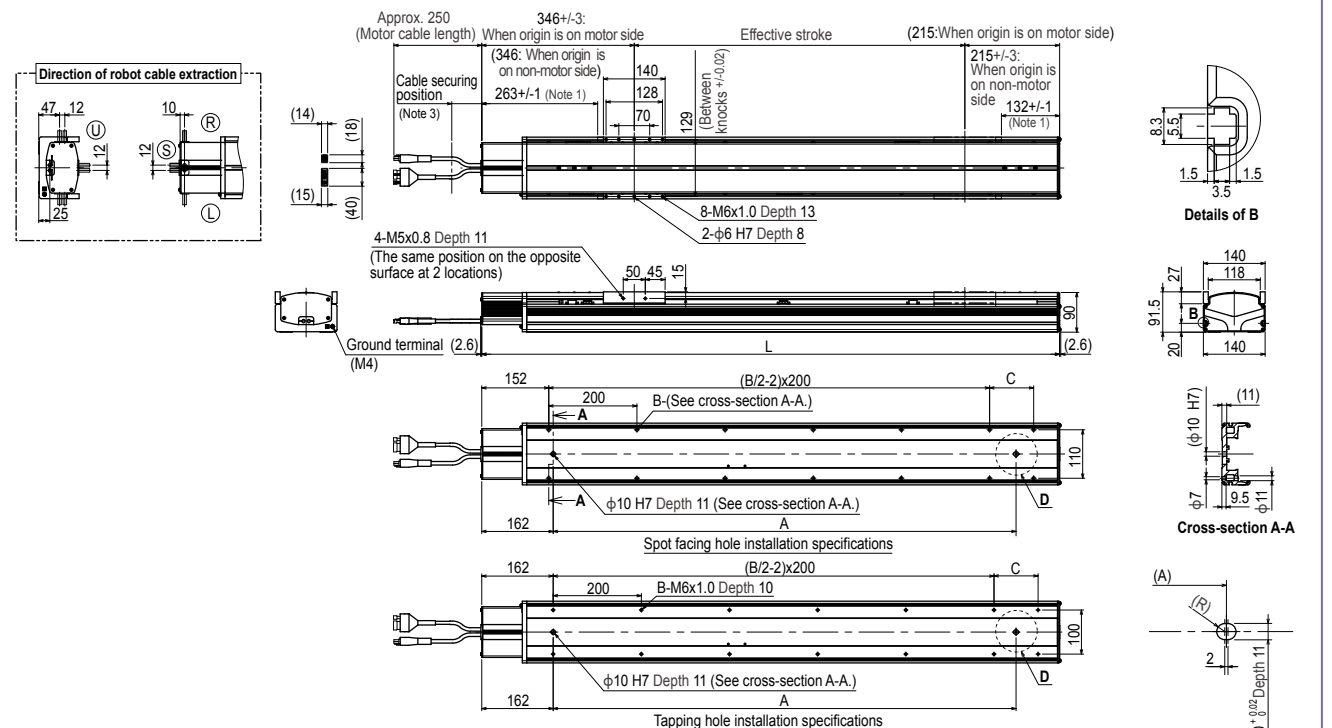

Note 1. Stop positions are determined by the mechanical stoppers at both ends.
 Note 2. When changing the return-to-origin direction, the adjustment is needed. (The standard is the origin on the motor side.)
 Note 3. Secure the cable with a tie-band 100mm or less from unit's end face to prevent the cable from being subjected to excessive loads.
 Note 4. The cable's minimum bend radius is R30.
 Note 5. The length under head of the hexagonal socket head bolts (M6 x 1.0) that are used to install the main body with the spot facing hole installation specifications is 20mm or more. It is recommended that the length under head of the hexagonal socket head bolts (M6 x 1.0) that are used to install the main body with the tapping hole installation specifications is the thickness of the installation base + 10mm or less.

Effective stroke	750	800	850	900	950	1000	1050	1100	1150	1200	1250	1300	1350	1400	1450	1500	1550	1600	1650	1700	1750	1800	1850	1900	1950	2000
L	1311	1361	1411	1461	1511	1561	1611	1661	1711	1761	1811	1861	1911	1961	2011	2061	2111	2161	2211	2261	2311	2361	2411	2461	2511	2561
A	1050	1100	1150	1200	1250	1300	1350	1400	1450	1500	1550	1600	1650	1700	1750	1800	1850	1900	1950	2000	2050	2100	2150	2200	2250	2300
B	14	14	14	16	16	16	16	18	18	18	18	20	20	20	20	22	22	22	22	24	24	24	24	26	26	26
C	100	150	200	50	100	150	200	50	100	150	200	50	100	150	200	50	100	150	200	50	100	150	200	50	100	150
Weight (kg)	22.5	23.2	23.8	24.5	25.2	25.9	26.5	27.2	27.9	28.6	29.2	29.9	30.6	31.3	31.9	32.6	33.3	33.9	34.6	35.3	36.0	36.6	37.3	38.0	38.7	39.3

- Articulated robots YA
- Linear conveyor modules LCM
- Single-axis robots CX
- Motor-less single axis actuator Robonity
- Compact single-axis robots TRANSEVO
- Single-axis robots FLIP-X
- Linear motor single-axis robots PHASER
- Cartesian robots XY-X
- SCARA robots YK-X
- Pick & place robots YP-X
- CLEAN CONTROLLER INFORMATION
- T type
- F type
- GF type
- N type
- B/R type

F17 High lead type: Lead 40

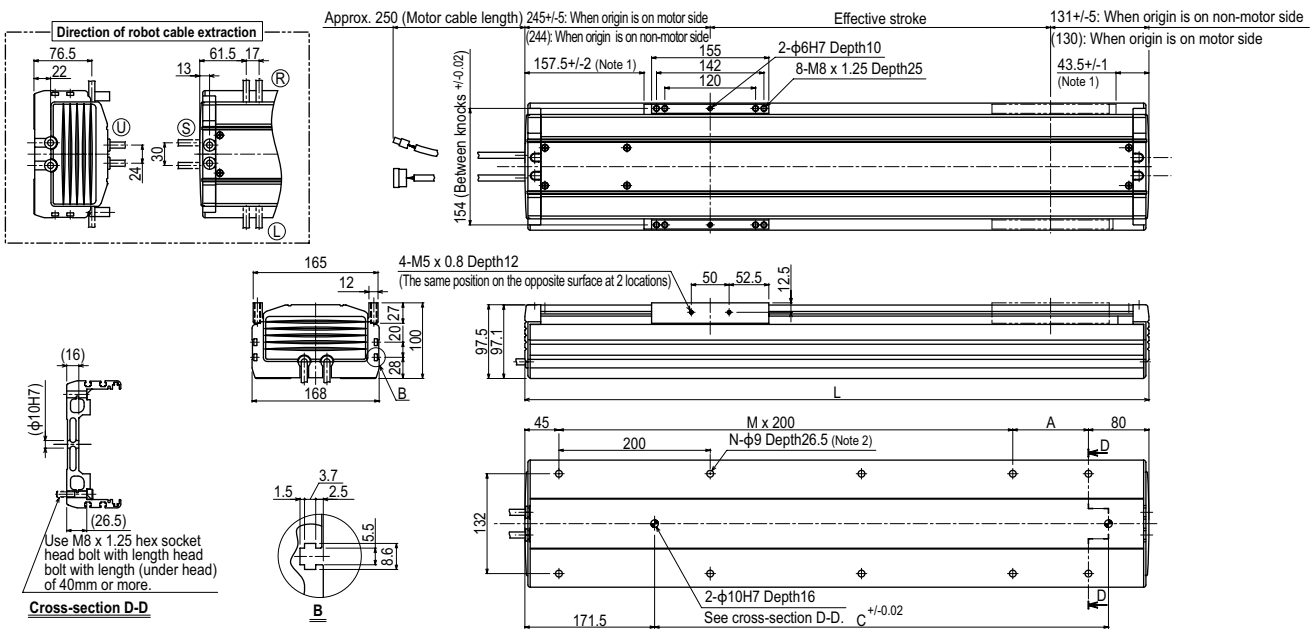

Note 1. Stop positions are determined by the mechanical stoppers at both ends.
 Note 2. When installing the robot, do not use washers inside the robot body.

Note 3. Minimum bend radius of motor cable is R50.

Effective stroke	200	250	300	350	400	450	500	550	600	650	700	750	800	850	900	950	1000	1050	1100	1150	1200	1250	1300	1350	1400	1450		
L	575	625	675	725	775	825	875	925	975	1025	1075	1125	1175	1225	1275	1325	1375	1425	1475	1525	1575	1625	1675	1725	1775	1825		
A	50	100	150	200	50	100	150	200	50	100	150	200	50	100	150	200	50	100	150	200	50	100	150	200	50	100		
M	2	2	2	2	3	3	3	3	4	4	4	4	5	5	5	5	6	6	6	6	7	7	7	7	8	8		
N	8	8	8	8	10	10	10	10	12	12	12	12	14	14	14	14	16	16	16	16	18	18	18	18	20	20		
C	240	240	420	420	420	600	600	600	600	780	780	780	780	960	960	960	960	1140	1140	1140	1140	1320	1320	1320	1320	1320		
Weight (kg)	14.7	15.5	16.4	17.2	18.0	18.8	19.7	20.5	21.3	22.1	23.0	23.8	24.6	25.4	26.3	27.1	27.9	28.7	29.6	30.4	31.2	32.0	32.8	33.6	34.4	35.2		
Maximum speed ^{Note 4} (mm/sec)	Lead 40 2400														1920	1680	1440	1200	960	840	720							
Speed setting	-														80%	70%	60%	50%	40%	35%	30%							

Note 4. When the stroke is longer than 800mm, resonance of the ball screw may occur depending on the operation conditions (critical speed). In this case, reduce the speed setting on the program by referring to the maximum speeds shown in the table above.

F17L

● Origin on the non-motor side is selectable

Note. Upper robot cable (U) on models with brakes is a special order item, so please consult our sales office or sales representative for assistance. (External dimensions: overall length + 20 mm)

Ordering method

F17L-50

Model	Lead designation	Brake	Cable entry location	Origin position change	Grease type	Stroke	Cable length ^{Note 2}
		No entry: No brakes BK: Brakes provided	No entry: Standard (S) U: From the top ^{Note 1} R: From the right L: From the left	None: Standard Z: Non-motor side	None: Standard GC: Clean	1100 to 2050 (50mm pitch)	3L: 3.5m 5L: 5m 10L: 10m 3K/5K/10K (Flexible cable)

TSX	220	R	I/O selection		Battery
Positioner ^{Note 3} TSX: TS-X	Driver: Power-supply voltage ^{Note 4} Power capacity ^{Note 4} 220: 200V/400 to 600W	Regenerative unit R: With RGT	LCD monitor No entry: None L: With LCD	NP: NPN PN: PNP CC: CC-Link DN: DeviceNet™ EP: EtherNet/IP™ PT: PROFINET GW: No I/O board ^{Note 5}	B: With battery (Absolute) N: None (Incremental)
SR1-X	20	R	I/O selection		Battery
Controller	Driver: Power capacity ^{Note 4} 20: 400 to 600W	Usable for CE No entry: Standard E: CE marking	Regenerative unit R: With RG1	N: NPN P: PNP CC: CC-Link DN: DeviceNet™ PB: PROFIBUS	B: With battery (Absolute) N: None (Incremental)
RDV-X	2	20	Regenerative unit		Battery
Driver	Power-supply voltage ^{Note 4} 2: AC200V	Driver: Power capacity ^{Note 4} 20: 600W or less	RBR1 (Horizontal) RBR2 (Vertical)		

- Note 1. Upper robot cable (U) on models equipped with brake is a special-order item.
 Note 2. The robot cable is standard cable (3L/5L/10L), but can be changed to flexible cable. See P.732 for details on robot cable.
 Note 3. See P.634 for DIN rail mounting bracket.
 Note 4. Acceleration / deceleration is different depending the Positioner or Controller or Driver.
 Note 5. Select this selection when using the gateway function. For details, see P.96.

Specifications

AC servo motor output (W)	600
Repeatability ^{Note 1} (mm)	+/-0.02
Deceleration mechanism	Ball screw φ25
Ball screw lead (mm)	50
Maximum speed ^{Note 2} (mm/sec)	2200
Maximum payload (kg)	Horizontal: 50 Vertical: 10
Rated thrust (N)	204
Stroke (mm)	1100 to 2050 (50mm pitch)
Overall length (mm)	Horizontal: Stroke+475 Vertical: Stroke+505
Maximum dimensions of cross section of main unit (mm)	W168 × H100
Cable length (m)	Standard: 3.5 / Option: 5.10
Linear guide type	4 rows of circular arc grooves × 2 rail
Position detector	Resolvers ^{Note 3}
Resolution (Pulse/rotation)	16384

- Note 1. Positioning repeatability in one direction.
 Note 2. When the stroke is longer than 1200mm, resonance of the ball screw may occur depending on the operation conditions (critical speed). In this case, reduce the speed setting on the program by referring to the maximum speeds shown in the table below.
 Note 3. Position detectors (resolvers) are common to incremental and absolute specifications. If the controller has a backup function then it will be absolute specifications.

Allowable overhang^{Note}

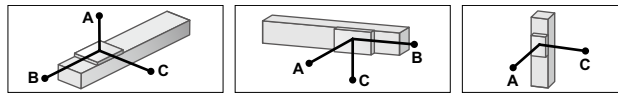

Lead 50	Horizontal installation (Unit: mm)			Wall installation (Unit: mm)			Vertical installation (Unit: mm)		
	A	B	C	A	B	C	A	B	C
10kg	4000	2755	2608	2720	2681	4000	2kg	1200	1200
30kg	3045	895	1175	1185	821	3045	5kg	3000	3000
50kg	2602	523	715	680	449	2602	10kg	2650	2650

Note. Distance from center of slider top to center of gravity of object being carried at a guide service life of 10,000 km.

Static loading moment

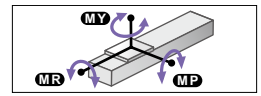

(Unit: N·m)		
MY	MP	MR
1032	1034	908

Controller

Controller	Operation method
SR1-X20-R RCX320 RCX221/222 RCX340	Programming / I/O point trace / Remote command / Operation using RS-232C communication
TS-X220-R RDV-X220-RBR1 (Horizontal) RDV-X220-RBR2 (Vertical)	I/O point trace / Remote command / Pulse train control

F17L

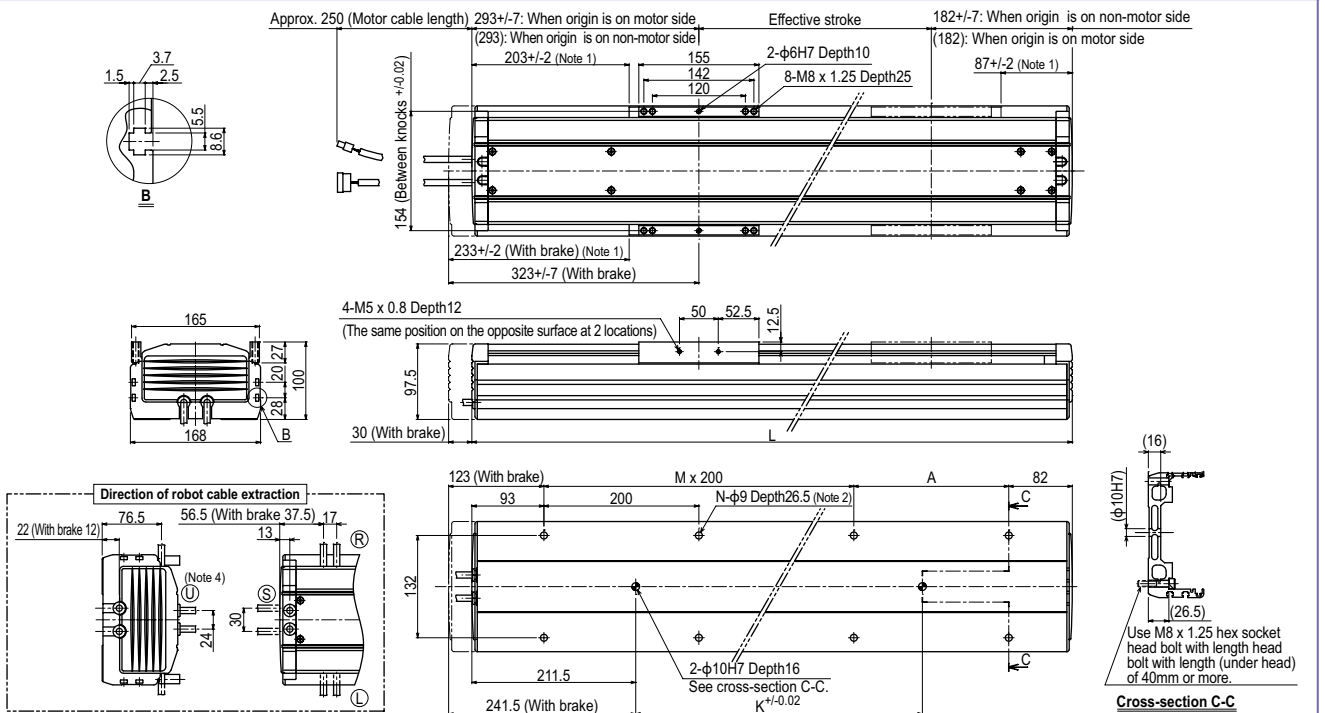

- Note 1. Stop positions are determined by the mechanical stoppers at both ends.
 Note 2. It is not allowed to use a counter bore washer, etc. when installing the main unit.
 Note 3. This is the weight of the model without a brake. The weight of the model equipped with a brake is 1.2kg heavier than this value.
 Note 4. Make a separate consultation with us regarding robot cable (brake specifications) U extraction. (External dimensions: overall length + 20 mm)

Effective stroke	1100	1150	1200	1250	1300	1350	1400	1450	1500	1550	1600	1650	1700	1750	1800	1850	1900	1950	2000	2050
L	1575	1625	1675	1725	1775	1825	1875	1925	1975	2025	2075	2125	2175	2225	2275	2325	2375	2425	2475	2525
A	200	50	100	150	200	50	100	150	200	50	100	150	200	50	100	150	200	50	100	150
M	6	7	7	7	7	8	8	8	8	8	9	9	9	10	10	10	10	11	11	11
N	16	18	18	18	18	20	20	20	20	22	22	22	22	24	24	24	24	26	26	26
K	1140	1140	1320	1320	1320	1320	1320	1320	1320	1320	1320	1320	1320	1320	1320	1320	1320	1320	1320	1320
Weight (kg) ^{Note 3}	34.1	34.9	35.8	36.7	37.6	38.4	39.3	40.2	41.1	42	42.9	43.8	44.7	45.6	46.5	47.3	48.2	49.1	50	50.9
Maximum speed ^{Note 5} (mm/sec)	2200		1900		1500		1200		900		800		40%		36%					
Speed setting	-		86%		68%		54%		40%		36%									

Note 5. When the stroke exceeds 1200mm, although depending on the moving range, the ball screw may resonate (critical speed). In that case, make adjustment to lower the speed on the program using the maximum speed given in the above table as a guide.

GF17XL

Origin on the non-motor side is selectable

Note. If you need an installation posture other than the horizontal installation, please contact us.

Ordering method

GF17XL - S H - 20

Model	Model	Installation direction	Lead designation	Cable entry location	Origin position change	Frame	Grease type	Stroke	Cable length
S: Straight model		H: Horizontal installation		No entry: Standard (S) U: From the top R: From the right L: From the left	None: Standard Z: Non-motor side	No entry: Standard (Spot facing) T: Tapping	None: Standard GC: Clean	850 to 2500 (50mm pitch)	3L: 3.5m 5L: 5m 10L: 10m 3K/5K/10K (Flexible cable)

TSX	220								
Positioner ^{Note 1} TSX: TS-X	Driver: Power-supply voltage / Power capacity 220: 200V/400 to 600W	Regenerative unit No entry: None R: With RGT	LCD monitor No entry: None L: With LCD	I/O selection N: NPN P: PNP CC: CC-Link DN: DeviceNet™ EP: EtherNet/IP™ PT: PROFINET GW: No I/O board ^{Note 2}	Battery B: With battery (Absolute) N: None (Incremental)				
SR1-X	20								
Controller	Driver: Power capacity 20: 400 to 600W	Usable for CE No entry: Standard E: CE marking	Regenerative unit ^{Note 4} No entry: None R: With RGT	I/O selection N: NPN P: PNP CC: CC-Link DN: DeviceNet™ EP: EtherNet/IP™ PB: PROFINET	Battery B: With battery (Absolute) N: None (Incremental)				
RDV-X	2	20							
Driver	Power-supply voltage 2: AC200V	Driver: Power capacity 20: 600W or less	Regenerative unit						

- Note 1. The robot cable is standard cable (3L/5L/10L), but can be changed to flexible cable. See P.732 for details on robot cable.
 Note 2. See P.634 for DIN rail mounting bracket.
 Note 3. Select this selection when using the gateway function. For details, see P.96.
 Note 4. When operating the robot at a speed that is a maximum speed of 750 mm/sec or less, the regenerative unit is not needed.

- [Cautions after purchase]
 • When changing the origin position, contact us since the adjustment is needed.
 • When changing the cable entry location, contact us since necessary parts may vary depending on the cable entry location.
 • Do not install the robot with the horizontal installation specifications in a direction other than the horizontal direction.

Specifications

AC servo motor output (W)	400
Repeatability ^{Note 1} (mm)	+/-0.01
Deceleration mechanism	Ball screw φ20
Ball screw lead (mm)	20
Maximum speed (mm/sec)	1200 ^{Note 2}
Maximum payload (kg)	90
Rated thrust (N)	339
Stroke (mm)	850 to 2500 (50mm pitch)
Overall length (mm)	Stroke+686
Maximum dimensions of cross section of main unit (mm)	W168×H105.5
Cable length (m)	Standard: 3.5 / Option: 5.10
Linear guide type	4 rows of circular arc grooves × 2 rail
Position detector	Resolvers ^{Note 3}
Resolution (Pulse/rotation)	20480

Allowable overhang^{Note}

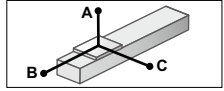

Horizontal installation (Unit: mm)			
	A	B	C
Lead 20	30kg 4050	1090	1405
	50kg 2755	650	835
	90kg 1610	345	450

Note. Distance from center of slider top to center of gravity of object being carried at a guide service life of 10,000 km.
 Note. Service life is calculated for 1000mm stroke models.

Static loading moment

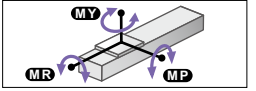

(Unit: N·m)		
MY	MP	MR
1032	1034	908

Controller

Controller	Operation method
SR1-X20 ^{Note} RCX320 RCX221/222 RCX340	Programming / I/O point trace / Remote command / Operation using RS-232C communication
TS-X220	I/O point trace / Remote command
RDV-X220-RBR1	Pulse train control

Note. To operate the unit at a speed exceeding 750 mm/sec. (Max. speed), a regeneration unit is required.

GF17XL

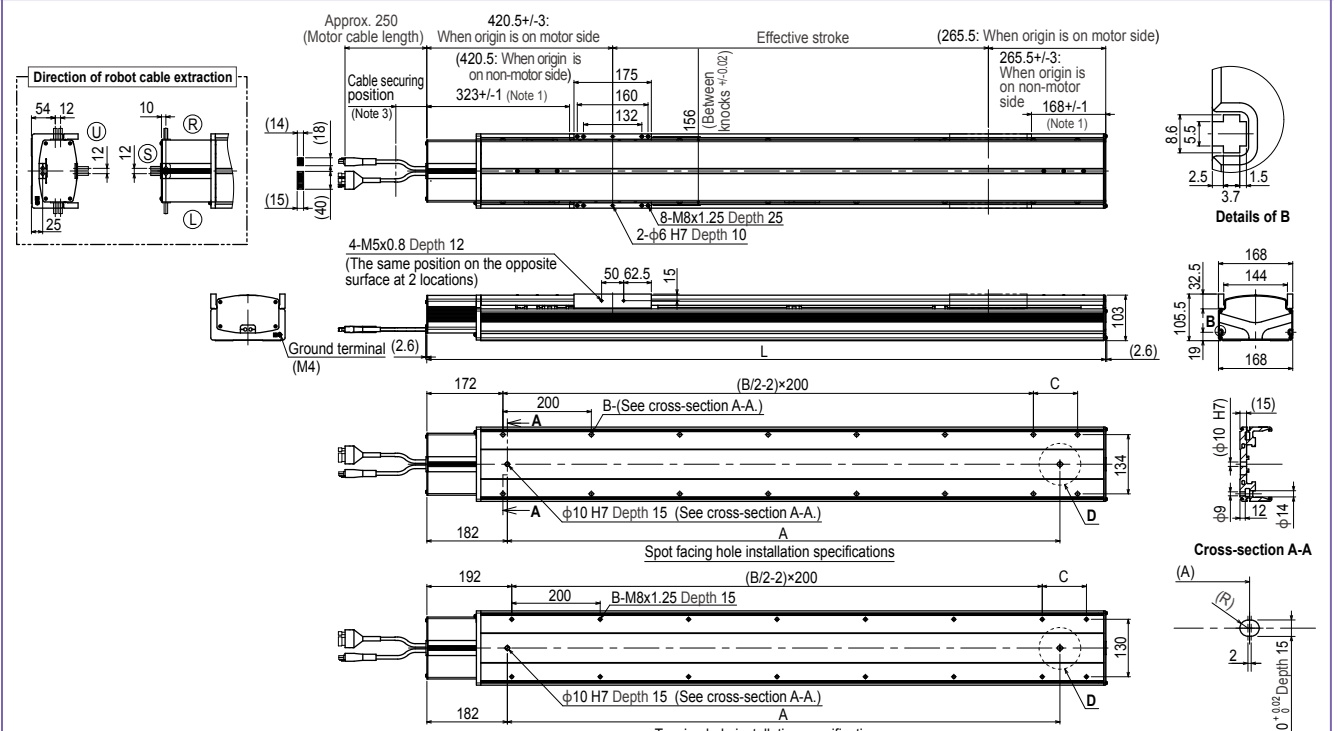

- Note 1. Stop positions are determined by the mechanical stoppers at both ends.
 Note 2. When changing the return-to-origin direction, the adjustment is needed. (The standard is the origin on the motor side.)
 Note 3. Secure the cable with a tie-band 100mm or less from unit's end face to prevent the cable from being subjected to excessive loads.
 Note 4. The cable's minimum bend radius is R30.
 Note 5. The length under head of the hexagonal socket head bolts (M8 x 1.25) that are used to install the main body with the spot facing hole installation specifications is 45 mm or more. It is recommended that the length under head of the hexagonal socket head bolts (M8 x 1.25) that are used to install the main body with the tapping hole installation specifications is the thickness of the installation base + 15 mm or less.

Effective stroke	850	900	950	1000	1050	1100	1150	1200	1250	1300	1350	1400	1450	1500	1550	1600	1650	1700	1750	1800	1850	1900	1950	2000	2050	2100	2150	2200	2250	2300	2350	2400	2450	2500
L	1536	1586	1636	1686	1736	1786	1836	1886	1936	1986	2036	2086	2136	2186	2236	2286	2336	2386	2436	2486	2536	2586	2636	2686	2736	2786	2836	2886	2936	2986	3036	3086	3136	3186
A	1250	1300	1350	1400	1450	1500	1550	1600	1650	1700	1750	1800	1850	1900	1950	2000	2050	2100	2150	2200	2250	2300	2350	2400	2450	2500	2550	2600	2650	2700	2750	2800	2850	2900
B	16	16	16	18	18	18	18	20	20	20	20	22	22	22	22	24	24	24	24	26	26	26	26	28	28	28	28	30	30	30	30	32	32	32
C	100	150	200	50	100	150	200	50	100	150	200	50	100	150	200	50	100	150	200	50	100	150	200	50	100	150	200	50	100	150	200	50	100	150
Weight (kg)	37.4	38.4	39.4	40.3	41.3	42.3	43.2	44.2	45.2	46.1	47.1	48.1	49.0	50.0	51.0	51.9	52.9	53.9	54.8	55.8	56.8	57.7	58.7	59.7	60.6	61.6	62.6	63.5	64.5	65.5	66.4	67.4	68.4	69.3

F20

- High lead: Lead 40
- Origin on the non-motor side is selectable

Note. Upper robot cable (U) on models with brakes is a special order item, so please consult our sales office or sales representative for assistance. (External dimensions: overall length + 20 mm)

Ordering method

F20

Model	Lead designation	Brake	Cable entry location	Origin position change	Grease type	Stroke	Cable length
	40: 40mm 20: 20mm 10: 10mm	No entry: BK: Brakes provided	No entry: Standard (S) U: From the top R: From the right L: From the left	None: Standard Z: Non-motor side	None: Standard GC: Clean	Lead 20: 10: 200 to 1250 (50mm pitch) Lead 40: 200 to 1450 (50mm pitch)	3L: 3.5m 5L: 5m 10L: 10m 3K/5K/10K (Flexible cable)

- Note 1. The model with a lead of 10mm cannot select specifications without brake (horizontal specifications).
The model with a lead of 40mm cannot select specifications with brake (vertical specifications).
Note 2. Upper robot cable (U) on models equipped with brake is a special-order item.
Note 3. The robot cable is standard cable (3L/5L/10L), but can be changed to flexible cable. See P.732 for details on robot cable.
Note 4. See P.634 for DIN rail mounting bracket.
Note 5. Acceleration / deceleration is different depending the Positioner or Controller or Driver.
Note 6. The robot with the high lead specifications (lead 40) needs a regenerative unit.
Note 7. Select this selection when using the gateway function. For details, see P.96.

TSX	220	SR1-X	20	RDV-X	2	20
Positioner TSX: TS-X	Driver: Power supply voltage Power capacity 220: 200V/400 to 600W	Controller	Driver: Power capacity 20: 400 to 600W	Driver	Power supply voltage 2: AC200V	Driver: Power capacity 20: 600W or less
	Regenerative unit No entry: None R: With RG1	Usable for CE No entry: Standard E: CE marking	Usable for CE No entry: Standard E: CE marking			Regenerative unit No entry: None R: With RG1
	LCD monitor No entry: None L: With LCD					
	I/O selection NP: NPN PN: PNP CC: CC-Link DN: DeviceNet™ EP: EtherNet/IP™ PT: PROFINET GW: No I/O board		I/O selection N: NPN P: PNP CC: CC-Link DN: DeviceNet™ PB: PROFIBUS			
	Battery No entry: None B: With battery (Absolute) N: None (Incremental)		Battery No entry: None B: With battery (Absolute) N: None (Incremental)			

Specifications

AC servo motor output (W)	600		
Repeatability (mm)	+/-0.01		
Deceleration mechanism	Ball screw φ20		
Ball screw lead (mm)	40	20	10
Maximum speed (mm/sec)	2400	1000 (1200)	600
Maximum payload (kg)	Horizontal 60	Vertical 120	45
Rated thrust (N)	255	510	1020
Stroke (mm)	200 to 1450 (50mm pitch)		
Overall length (mm)	Horizontal Stroke+427	Vertical Stroke+417	-
Maximum dimensions of cross section of main unit (mm)	W202 × H115		
Cable length (m)	Standard: 3.5 / Option: 5.10		
Linear guide type	4 rows of circular arc grooves × 2 rail		
Position detector	Resolvers		
Resolution (Pulse/rotation)	16384		

- Note 1. Positioning repeatability in one direction.
Note 2. When the stroke is longer than 800mm, resonance of the ball screw may occur depending on the operation conditions (critical speed). In this case, reduce the speed setting on the program by referring to the maximum speeds shown in the table below.
Note 3. To operate the unit at a speed exceeding 1,000mm/sec. (Max. speed), a regeneration unit RG1 is required.
Note 4. Longer than 1250mm stroke can be handled by the high lead specification (Lead 40) only.
Note 5. Position detectors (resolvers) are common to incremental and absolute specifications. If the controller has a backup function then it will be absolute specifications.

Allowable overhang

Lead	Horizontal installation (Unit: mm)			Wall installation (Unit: mm)			Vertical installation (Unit: mm)		
	A	B	C	A	B	C	A	C	
Lead 40	10kg 4000	4000	3450	10kg 3571	4000	4000	15kg 2635	2635	
Lead 20	20kg 3397	2235	2073	20kg 2118	2164	3397	20kg 2000	2000	
	60kg 2443	718	977	60kg 1000	648	2443	25kg 1621	1621	
Lead 10	50kg 2602	869	1083	50kg 1097	799	2602	20kg 2188	2188	
	80kg 2193	528	703	80kg 708	458	2193	30kg 1446	1446	
	120kg 1841	339	505	120kg 468	268	1841	45kg 951	951	

Note. Distance from center of slider top to center of gravity of object being carried at a guide service life of 10,000 km.

Static loading moment

(Unit: N·m)		
MY	MP	MR
1196	1199	1052

Controller

Controller	Operation method
SR1-X20	Programming / I/O point trace / Remote command / Operation using RS-232C communication
TS-X220	I/O point trace / Remote command
RDV-X220-RBR1 (Horizontal)	Pulse train control
RDV-X220-RBR2 (Vertical)	

- Note. [The following arrangements require a regeneration unit.]
 • Using in the upright position.
 • To move at a speed exceeding 1,000 mm/sec horizontally.
 • High lead (40) used horizontally.

F20

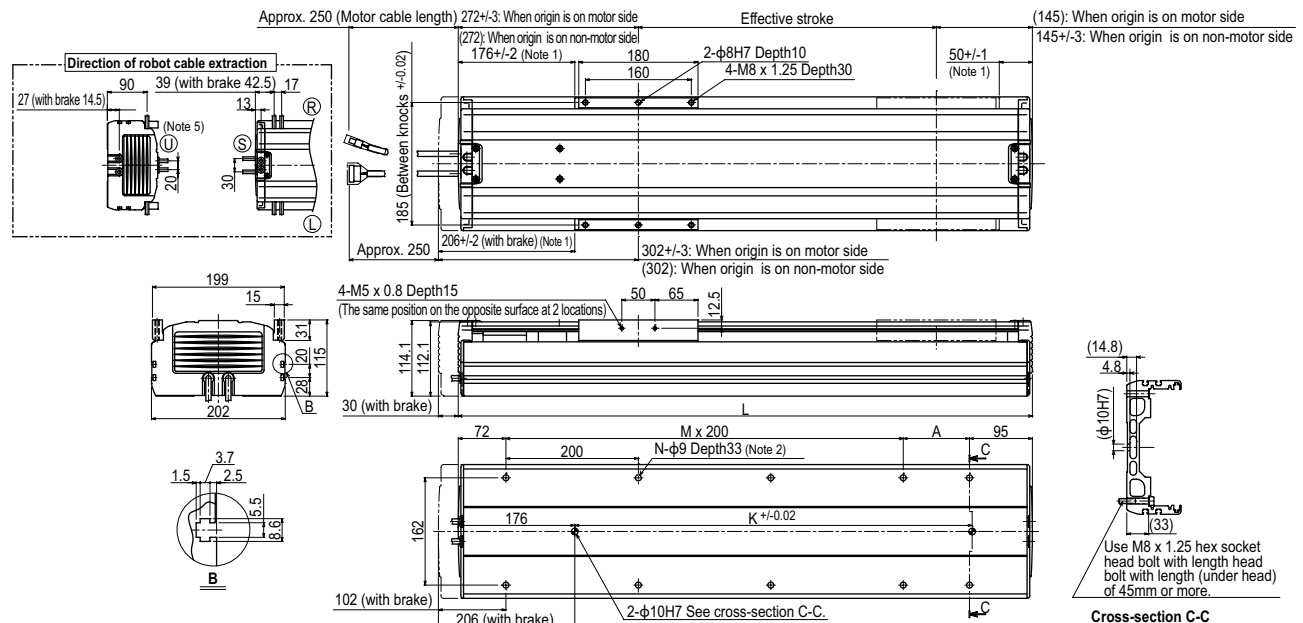

- Note 1. Stop positions are determined by the mechanical stoppers at both ends.
 Note 2. When installing the robot, do not use washers inside the robot body.
 Note 3. Minimum bend radius of motor cable is R50.
 Note 4. Weight of models with no brake. The weight of brake-attached models is 1.5 kg heavier than the models with no brake shown in the table.
 Note 5. Make a separate consultation with us regarding robot cable (brake specifications) U extraction. (External dimensions: overall length + 20 mm)

Effective stroke	200	250	300	350	400	450	500	550	600	650	700	750	800	850	900	950	1000	1050	1100	1150	1200	1250
L	617	667	717	767	817	867	917	967	1017	1067	1117	1167	1217	1267	1317	1367	1417	1467	1517	1567	1617	1667
A	50	100	150	200	50	100	150	200	50	100	150	200	50	100	150	200	50	100	150	200	50	100
M	2	2	2	2	3	3	3	3	4	4	4	4	5	5	5	5	6	6	6	6	7	7
N	8	8	8	8	10	10	10	10	12	12	12	12	14	14	14	14	16	16	16	16	18	18
K	420	420	420	420	600	600	600	600	780	780	780	780	960	960	960	960	1140	1140	1140	1320	1320	1320
Weight (kg)	21.0	22.0	22.9	23.8	24.8	25.7	26.6	27.5	28.5	29.4	30.3	31.2	32.1	33.0	34.0	34.9	35.8	36.7	37.7	38.6	39.5	40.4
Maximum speed (mm/sec)	1000 (1200)										960		840		720		600		480		480	
Speed setting	-										80%		70%		60%		50%		40%		40%	

- Note 6. When the stroke exceeds 800mm, although depending on the moving range, the ball screw may resonate (critical speed). In that case, make adjustment to lower the speed on the program using the maximum speed given in the above table as a guide.
 Note 7. To operate the unit at a speed exceeding 1,000mm/sec. a regeneration unit RG1 is required.

F20N



Ordering method

F20N - 20					
Model	Lead designation	Origin position change	Grease type	Stroke	Cable length^{Note 1}
		None: Standard Z: Non-motor side	None: Standard GC: Clean	1150 to 2050 (100mm pitch)	3L: 3.5m 5L: 5m 10L: 10m 3K/5K/10K (Flexible cable)

TSX	220				
Positioner^{Note 2}	Driver: Power-supply voltage / Power capacity	Regenerative unit	LCD monitor	I/O selection	Battery
TSX: TS-X	220: 200V/400 to 600W	No entry: None R: With RGT	No entry: None L: With LCD	NP: NPN PN: PNP CC: CC-Link DN: DeviceNet™ EP: EtherNet/IP™ PT: PROFINET GW: No I/O board ^{Note 3}	B: With battery (Absolute) N: None (Incremental)
SR1-X	20				
Controller	Driver: Power capacity	Usable for CE	Regenerative unit	I/O selection	Battery
	20: 400 to 600W	No entry: Standard E: CE marking	No entry: None R: With RGT	N: NPN P: PNP CC: CC-Link DN: DeviceNet™ PB: PROFIBUS	B: With battery (Absolute) N: None (Incremental)
RDV-X	2	20		RBR1	
Driver	Power-supply voltage	Driver: Power capacity		Regenerative unit	
	2: AC200V	20: 600W or less			

Note 1. The robot cable is standard cable (3L/5L/10L), but can be changed to flexible cable. See P.732 for details on robot cable.
 Note 2. See P.634 for DIN rail mounting bracket.
 Note 3. Select this selection when using the gateway function. For details, see P.96.

Specifications

AC servo motor output (W)	400
Repeatability^{Note 1} (mm)	+/-0.04
Deceleration mechanism	Ball screw $\phi 20$
Ball screw lead (mm)	20
Maximum speed (mm/sec)	1000 (1200 ^{Note 2})
Maximum payload (kg)	80
Rated thrust (N)	339
Stroke (mm)	1150 to 2050 (100mm pitch)
Overall length (mm)	Stroke+420
Maximum dimensions of cross section of main unit (mm)	W202 x H120
Cable length (m)	Standard: 3.5 / Option: 5.10
Linear guide type	4 rows of circular arc grooves x 2 rail
Position detector	Resolvers ^{Note 3}
Resolution (Pulse/rotation)	16384

Note 1. Positioning repeatability in one direction.
 Note 2. A regenerative unit is needed if using the SR1-X, TS-X at maximum speeds exceeding 1000mm/sec.. If using the RDV-X, then the regenerative unit RBR1 is required regardless of the installation conditions.
 Note 3. Position detectors(resolvers) are common to incremental and absolute specifications. If the controller has a backup function then it will be absolute specifications.

Allowable overhang^{Note}

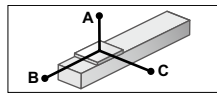

		Horizontal installation (Unit: mm)		
		A	B	C
Lead 20	20kg	3397	2332	2683
	40kg	2795	1144	1361
	60kg	2443	749	914
	80kg	2193	551	695

Note. Distance from center of slider top to center of gravity of object being carried at a guide service life of 10,000 km.

Static loading moment

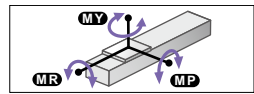

			(Unit: N·m)
MY	MP	MR	
1196	1199	1052	

Controller

Controller	Operation method
SR1-X20 ^{Note} RCX320 RCX221/222 RCX340	Programming / I/O point trace / Remote command / Operation using RS-232C communication
TS-X220 ^{Note} RDV-X220-RBR1	I/O point trace / Remote command / Pulse train control

Note. When the unit is operated at a speed exceeding the maximum speed of 1,000mm/sec., a regeneration unit is required.

F20N

219+/-3: When origin is on L side
(219): When origin is on R side

Effective stroke

201+/-3: When origin is on R side
(201): When origin is on L side

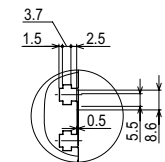
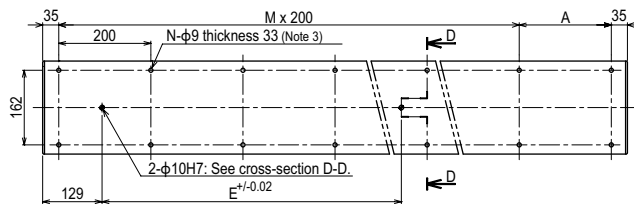
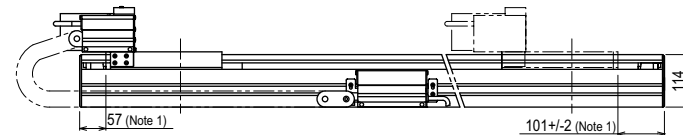
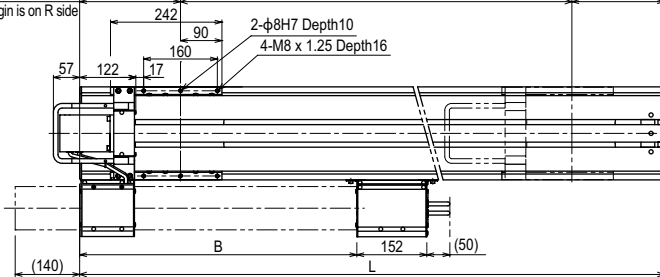

C section detailed chart

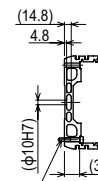
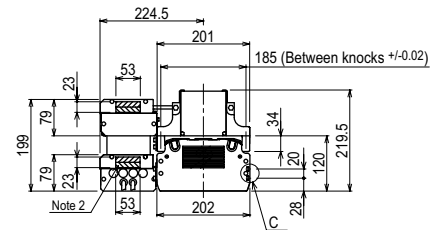

Cross section of cable guide

Use M8 x 1.25 hex socket head bolt with length head bolt with length (under head) of 45mm or more.

Cross-section D-D

Effective stroke	1150	1250	1350	1450	1550	1650	1750	1850	1950	2050
L	1570	1670	1770	1870	1970	2070	2170	2270	2370	2470
A	100	200	100	200	100	200	100	200	100	200
B	602	648	694	740	786	832	878	924	970	1016
E	1320	1320	1320	1320	1320	1320	1320	1320	1320	1320
M	7	7	8	8	9	9	10	10	11	11
N	18	18	20	20	22	22	24	24	26	26
Weight (kg)	54.0	56.2	58.4	60.6	62.9	65.1	67.3	69.6	71.8	74.0

Note 1. Stop positions are determined by the mechanical stoppers at both ends.
 Note 2. The shaded position indicates the user cable extraction port.
 Note 3. When installing the robot, do not use washers inside the robot body.
 Note 4. The origin is set on the left (L) side of the sliding.

N15



Ordering method

N15-20

Model	Lead designation	Cable carrier entry location	Cable carrier specification	Origin position change	Grease type	Stroke	Cable length
		RH: Horizontal, right LH: Horizontal, left RW: Wall, right LW: Wall, left	S: Standard C: Cable carrier M: Optional C: Cable carrier	Hori- zontal None: R side (Standard) Z: L side Wall None: L side (Standard) Z: R side	None: Standard GC: Clean	500 to 2000 (100mm pitch)	3L: 3.5m 5L: 5m 10L: 10m 3K/5K/10K (Flexible cable)

TSX	220	R			
Positioner TSX: TS-X	Driver: Power-supply voltage / Power capacity 220: 200V/400 to 600W	Regenerative unit R: With RGT	LCD monitor No entry: None L: With LCD	I/O selection NP: NPN PN: PNP CC: CC-Link DN: DeviceNet™ EP: EtherNet/IP™ PT: PROFINET GW: No I/O board	Battery B: With battery (Absolute) N: None (Incremental)
SR1-X	20	R			
Controller	Driver: Power capacity 20: 400 to 600W	Usable for CE No entry: Standard E: CE marking	Regenerative unit R: With RGT1	I/O selection N: NPN P: PNP CC: CC-Link DN: DeviceNet™ PB: PROFIBUS	Battery B: With battery (Absolute) N: None (Incremental)
RDV-X	2	20		RBR1	
Driver	Power-supply voltage 2: AC200V	Driver: Power capacity 20: 600W or less		Regenerative unit	

Note 1. To find information on cable carrier extraction directions see P.299.
 Note 2. The robot cable is standard cable (3L/5L/10L), but can be changed to flexible cable. See P.732 for details on robot cable.
 Note 3. See P.634 for DIN rail mounting bracket.
 Note 4. Select this selection when using the gateway function. For details, see P.96.

Specifications

AC servo motor output (W)	400
Repeatability (mm)	+/-0.01
Deceleration mechanism	Ball screw $\phi 15$
Ball screw lead (mm)	20
Maximum speed (mm/sec)	1200
Maximum payload (kg)	50
Rated thrust (N)	339
Stroke (mm)	500 to 2000 (100mm pitch)
Overall length (mm)	Stroke+330
Maximum dimensions of cross section of main unit (mm)	W145 x H120
Cable length (m)	Standard: 3.5 / Option: 5.10
Linear guide type	4 rows of circular arc grooves x 2 rail
Position detector	Resolvers
Resolution (Pulse/rotation)	16384

Note 1. Positioning repeatability in one direction.
 Note 2. The maximum speed may not be reached when the moving distance is short.
 Note 3. Position detectors (resolvers) are common to incremental and absolute specifications. If the controller has a backup function then it will be absolute specifications.

Allowable overhang

Horizontal installation	(Unit: mm)		
	A	B	C
Lead 20	10kg	3048	2322
	30kg	1489	841
	50kg	1278	544
Wall installation	(Unit: mm)		
	A	B	C
Lead 20	10kg	1258	1823
	30kg	428	545
	50kg	248	289

Note. Distance from center of slider top to center of gravity of object being carried at a guide service life of 10,000 km.

Static loading moment

(Unit: N·m)		
MY	MP	MR
691	692	608

Controller

Controller	Operation method
SR1-X20-R RCX320 RCX221/222 RCX340	Programming / I/O point trace / Remote command / Operation using RS-232C communication
TS-X220-R	I/O point trace / Remote command
RDV-X220-RBR1	Pulse train control

Cable carrier for users

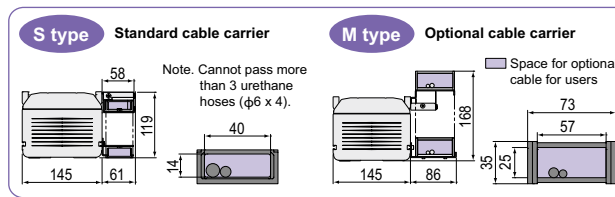

N15: Horizontal installation / Standard Cable carrier specification

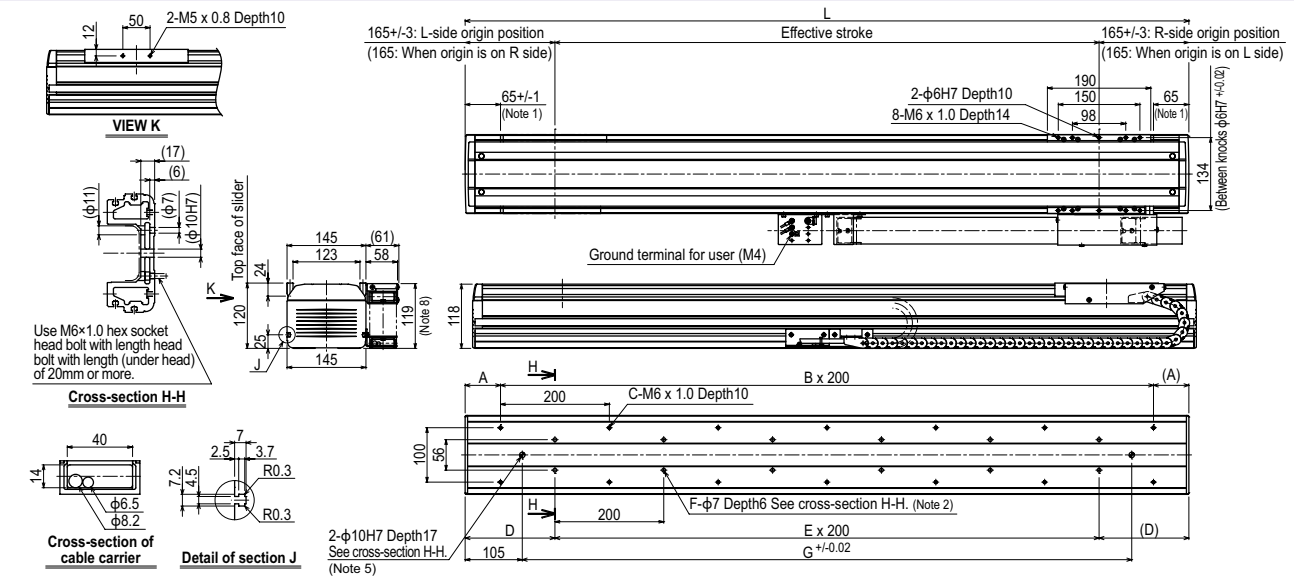

Note 1. Stop positions are determined by the mechanical stoppers at both ends.
 Note 2. When using $\phi 7$ holes for installation, do not use a washer, spring washer, etc. in the main unit.
 Note 3. When shipped from the factory, the horizontal model has the origin on the right side and the wall model has the origin on the left side. (This diagram shows the machine whose cable carrier taken out from right.)
 Note 4. If the model is a standard cable carrier specification, it is not possible to pass 3 or more $\phi 6 \times 4$ urethane air hoses.
 Note 5. When using a $\phi 10H7$ hole, make sure that the pin does not go into deeper than as shown in the drawing.
 Note 6. Contact us for vertical installation.
 Note 7. Weight of models with no brake. The weight of brake-attached models is 1 kg heavier than the models with no brake shown in the table.
 Note 8. Depending on the stroke and the operating conditions, the cable carrier bending radius might be larger, making it higher than the dimensions shown in the diagram.

Effective stroke	500	600	700	800	900	1000	1100	1200	1300	1400	1500	1600	1700	1800	1900	2000
L	830	930	1030	1130	1230	1330	1430	1530	1630	1730	1830	1930	2030	2130	2230	2330
A	15	65	15	65	15	65	15	65	15	65	15	65	15	65	15	65
B	4	4	5	5	6	6	7	7	8	8	9	9	10	10	11	11
C	10	10	12	12	14	14	16	16	18	18	20	20	22	22	24	24
D	115	165	115	165	115	165	115	165	115	165	115	165	115	165	115	165
E	3	3	4	4	5	5	6	6	7	7	8	8	9	9	10	10
F	8	8	10	10	12	12	14	14	16	16	18	18	20	20	22	22
G	620	720	820	920	1020	1120	1220	1320	1420	1520	1620	1720	1820	1920	2020	2120
Weight (kg)	19	20	22	23	24	26	27	29	30	32	33	35	36	38	39	40

N15D

● Double carriage

Ordering method

N15D-20							
Model	Lead designation	Installation direction	Cable carrier specification	Option	Stroke	Cable length	Controller ^{Note 1}
		H: Horizontal installation W: Wall installation	S: Standard Cable carrier M: Optional Cable carrier	Grease type: None: Standard GC: Clean	250 to 1750 (100mm pitch)	3L: 3.5m 5L: 5m 10L: 10m 3K/5K/10K (Flexible cable) ^{Note 3}	RCX320 RCX222HP SR1-X (2 units) ^{Note 2} TS-X (2 units) ^{Note 2} RDV-X (2 units) ^{Note 2}

Note 1. To find controller selection options, see the ordering method on each controller page.
 Note 2. 2 units are required when using SR1-X, TS-X or RDV-X.
 Note 3. If a flexible cable is needed for the SR1-X, TS-X, or RDV-X, then select 3K/5K/10K. On the RCX320/RCX222HP, the standard cable is a flexible cable, so enter 3L/5L/10L when ordering.

Specifications

AC servo motor output (W)	400
Repeatability ^{Note 1} (mm)	+/-0.01
Deceleration mechanism	Ball screw $\phi 15$
Ball screw lead (mm)	20
Maximum speed ^{Note 2} (mm/sec)	1200
Maximum payload (kg)	50
Rated thrust (N)	339
Stroke (mm)	250 to 1750 (100mm pitch)
Overall length (mm)	Stroke+330
Maximum dimensions of cross section of main unit (mm)	W145 x H120
Cable length (m)	Standard: 3.5 / Option: 5.10
Linear guide type	4 rows of circular arc grooves x 2 rail
Position detector	Resolvers ^{Note 3}
Resolution (Pulse/rotation)	16384

Note 1. Positioning repeatability in one direction.
 Note 2. The maximum speed may not be reached when the moving distance is short.
 Note 3. Position detectors (resolvers) are common to incremental and absolute specifications. If the controller has a backup function then it will be absolute specifications.

Allowable overhang^{Note}

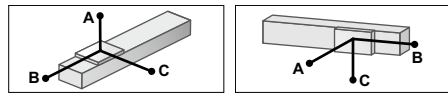

Lead 20	Horizontal installation (Unit: mm)			Wall installation (Unit: mm)		
	A	B	C	A	B	C
10kg	3048	2322	1259	1258	1823	2449
30kg	1489	841	500	428	545	1039
50kg	1278	544	344	248	289	749

Note. Distance from center of slider top to center of gravity of object being carried at a guide service life of 10,000 km.

Static loading moment

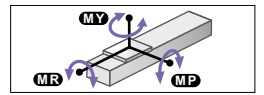

(Unit: N·m)		
MY	MP	MR
691	692	608

Controller

Controller	Operation method
RCX320-R RCX222HP-R	Programming / I/O point trace / Remote command / Operation using RS-232C communication
SR1-X20-R ^{Note}	I/O point trace / Remote command
TS-X220-R ^{Note}	I/O point trace / Remote command
RDV-X20-RBR1 ^{Note}	Pulse train control

Note. 2 units are required when using SR-1, TS-X or RDV-X.

Cable carrier for users

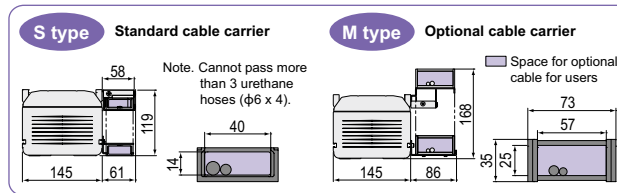

N15D: Horizontal installation / Standard Cable carrier specification

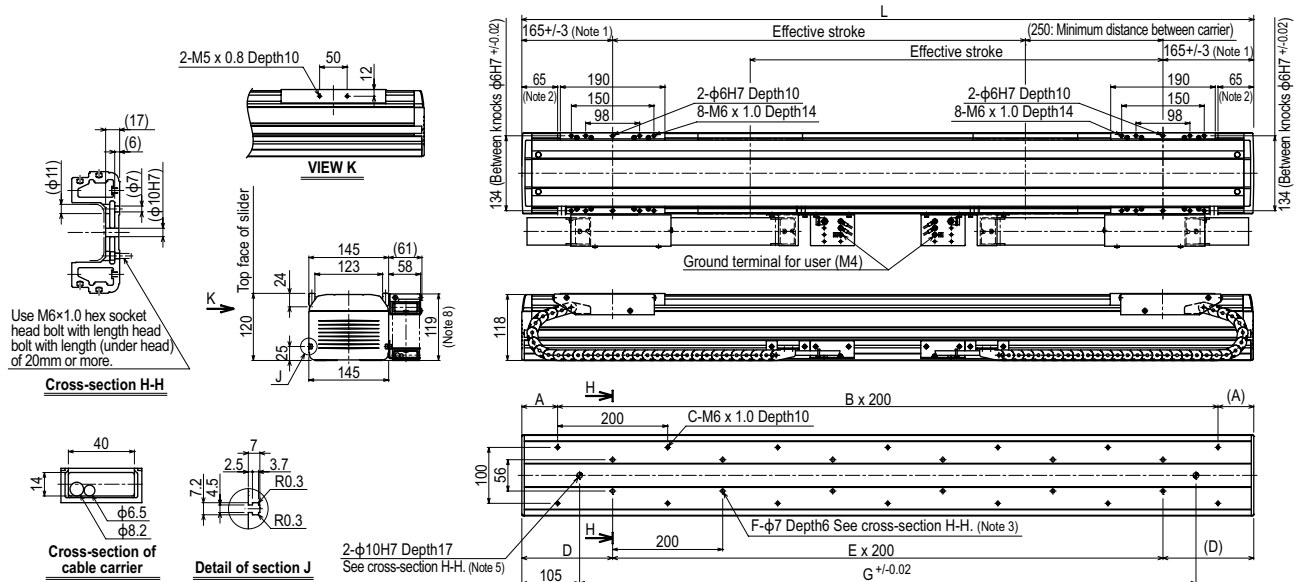

Note 1. Position of table carriage when searched to the origin.
 Note 2. Stop positions are determined by the mechanical stoppers at both ends.
 Note 3. When using $\phi 7$ holes for installation, do not use a washer, spring washer, etc. in the main unit.
 Note 4. If the model is a standard cable carrier specification, it is not possible to pass 3 or more $\phi 6 \times 4$ urethane air hoses.
 Note 5. When using a $\phi 10H7$ hole, make sure that the pin does not go into deeper than as shown in the drawing.
 Note 6. Contact us for vertical installation.
 Note 7. Weight of models with no brake. The weight of brake-attached models is 1 kg heavier than the models with no brake shown in the table.
 Note 8. Depending on the stroke and the operating conditions, the cable carrier bending radius might be larger, making it higher than the dimensions shown in the diagram.

Effective stroke	250	350	450	550	650	750	850	950	1050	1150	1250	1350	1450	1550	1650	1750
L	830	930	1030	1130	1230	1330	1430	1530	1630	1730	1830	1930	2030	2130	2230	2330
A	15	65	15	65	15	65	15	65	15	65	15	65	15	65	15	65
B	4	4	5	5	6	6	7	7	8	8	9	9	10	10	11	11
C	10	10	12	12	14	14	16	16	18	18	20	20	22	22	24	24
D	115	165	115	165	115	165	115	165	115	165	115	165	115	165	115	165
E	3	3	4	4	5	5	6	6	7	7	8	8	9	9	10	10
F	8	8	10	10	12	12	14	14	16	16	18	18	20	20	22	22
G	620	720	820	920	1020	1120	1220	1320	1420	1520	1620	1720	1820	1920	2020	2120
Weight (kg) ^{Note 7}	24	26	27	29	30	32	33	35	36	38	39	40	42	43	45	46

Articulated
robots
YA

Linear conveyor/
modules
LCM

Single-axis robots
CX

Multi-axis single
axis actuator
Robotomy

Compact
single-axis robots
TRANSEVO

Single-axis robots
FLIP-X

Linear motor
single-axis robots
PHASER

Cartesian
robots
XY-X

SCARA
robots
YK-X

Pick & place
robots
YP-X

CLEAN

CONTROLLER

INFORMATION

T type

F type

GF type

N type

BR type

N15D: Horizontal installation / Optional Cable carrier specification

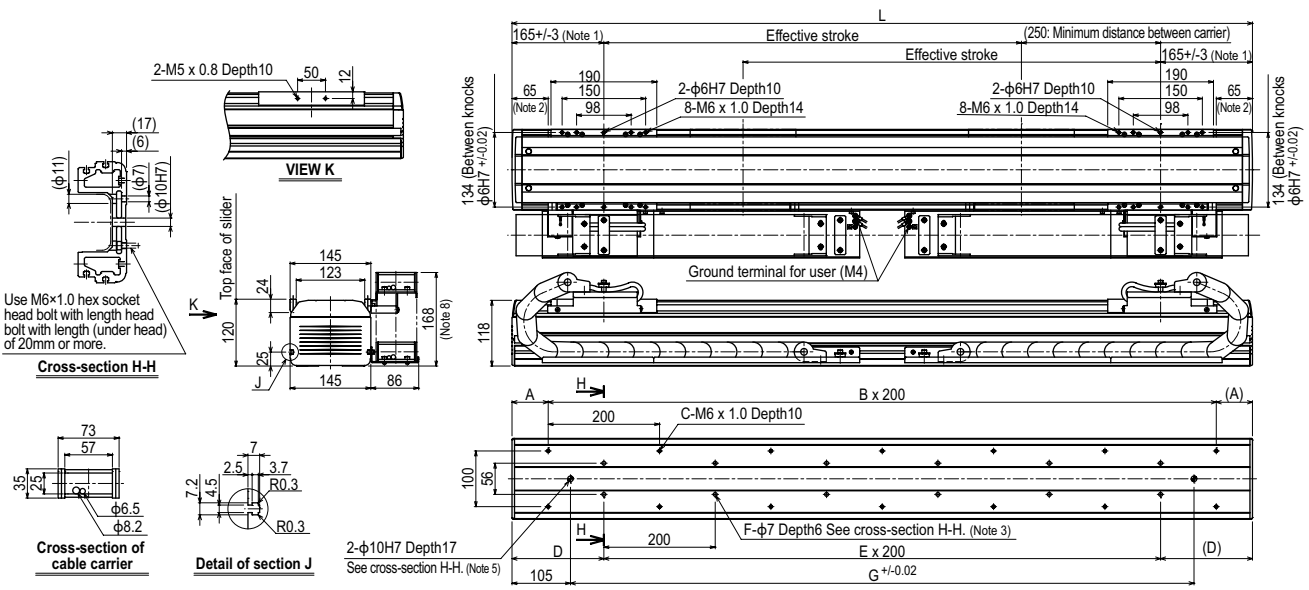

N15D: Wall installation / Standard Cable carrier specification

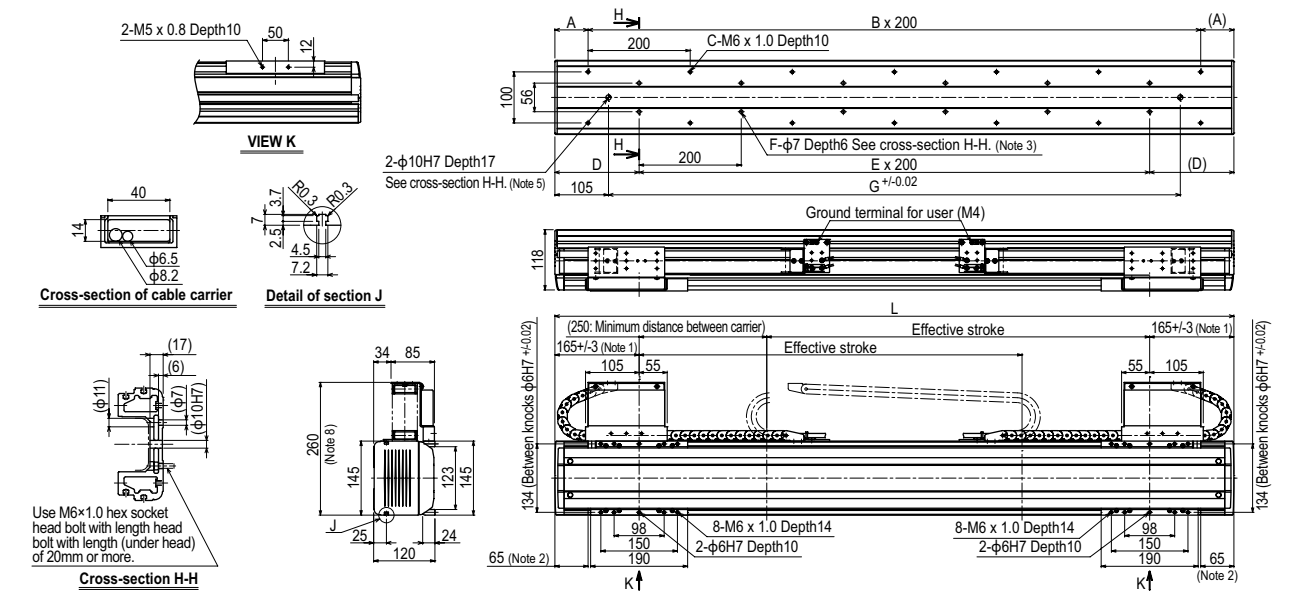

N15D: Wall installation / Optional Cable carrier specification

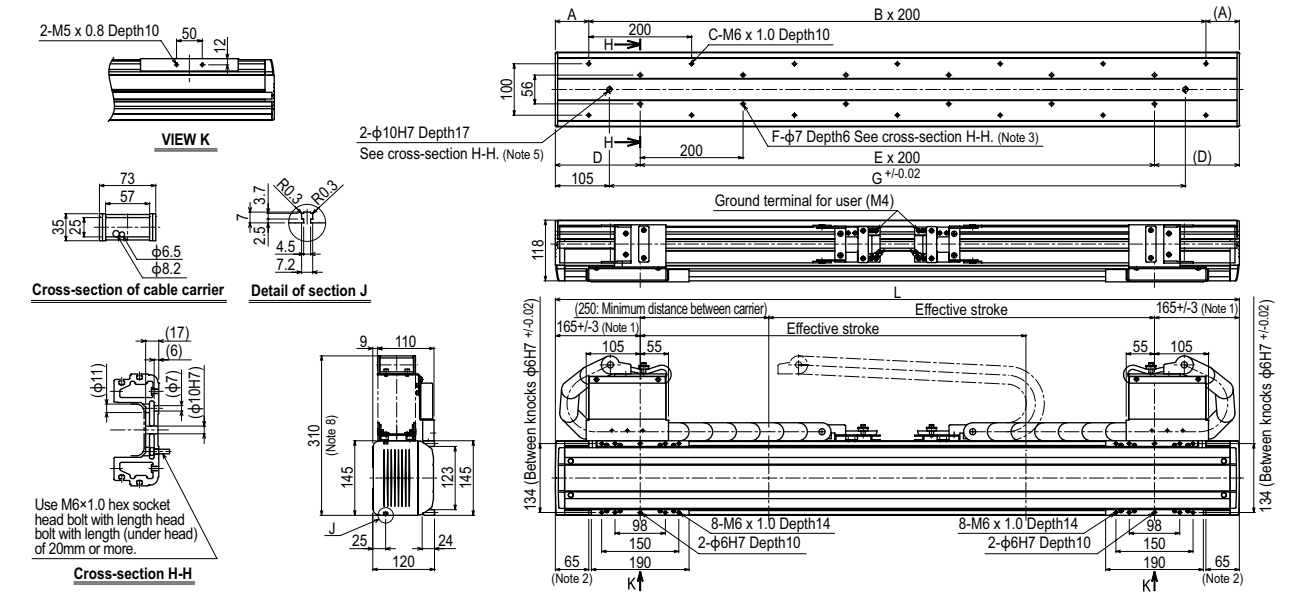

N18



Ordering method

N18-20

Model	Lead designation	Cable carrier entry location	Cable carrier specification	Origin position change	Grease type	Stroke	Cable length	Positioner	Driver: Power-supply voltage / Power capacity	Regenerative unit	LCD monitor	I/O selection	Battery
		RH: Horizontal, right LH: Horizontal, left RW: Wall, right LW: Wall, left	S: Standard M: Optional C: Cable carrier	Horizontal None: R side (Standard) Z: L side Wall None: L side (Standard) Z: R side	None: Standard GC: Clean	500 to 2500 (100mm pitch)	3L: 3.5m 5L: 5m 10L: 10m 3K/5K/10K (Flexible cable)	TSX TSX: TS-X	220: 200V/400 to 600W	R R: With RGT	No entry: None L: With LCD	NP: NPN PN: PNP CC: CC-Link DN: DeviceNet™ EP: EtherNet/IP™ PT: PROFINET GW: No I/O board	B: With battery (Absolute) N: None (Incremental)

SR1-X	20	R	I/O selection	Battery
Controller	Driver: Power capacity 20: 400 to 600W	Usable for CE No entry: Standard E: CE marking	No entry: None R: With RGT	N: NPN P: PNP CC: CC-Link DN: DeviceNet™ PB: PROFIBUS

RDV-X	2	20	RBR1
Driver	Power-supply voltage 2: AC200V	Driver: Power capacity 20: 600W or less	Regenerative unit

Note 1. To find information on cable carrier extraction directions see P.299.
 Note 2. The robot cable is standard cable (3L/5L/10L), but can be changed to flexible cable. See P.732 for details on robot cable.
 Note 3. See P.634 for DIN rail mounting bracket.
 Note 4. Select this selection when using the gateway function. For details, see P.96.

Specifications

AC servo motor output (W)	400
Repeatability ^{Note 1} (mm)	+/-0.01
Deceleration mechanism	Ball screw φ20
Ball screw lead (mm)	20
Maximum speed ^{Note 2} (mm/sec)	1200
Maximum payload (kg)	80
Rated thrust (N)	339
Stroke (mm)	500 to 2500 (100mm pitch)
Overall length (mm)	Stroke+362
Maximum dimensions of cross section of main unit (mm)	W180 × H115
Cable length (m)	Standard: 3.5 / Option: 5.10
Linear guide type	4 rows of circular arc grooves × 2 rail
Position detector	Resolvers ^{Note 3}
Resolution (Pulse/rotation)	16384

Note 1. Repeatability for single oscillation.
 Note 2. The maximum speed may not be reached when the moving distance is short.
 Note 3. Position detectors (resolvers) are common to incremental and absolute specifications. If the controller has a backup function then it will be absolute specifications.

Allowable overhang^{Note}

Horizontal installation (Unit: mm)	Horizontal installation (Unit: mm)			Wall installation (Unit: mm)		
	A	B	C	A	B	C
Lead 20	30kg 3045	1629	1902	30kg 1928	1553	3045
	50kg 2602	961	1150	50kg 1157	885	2602
	80kg 2193	586	716	80kg 707	509	2193

Note. Distance from center of slider top to center of gravity of object being carried at a guide service life of 10,000 km.

Static loading moment

(Unit: N·m)		
MY	MP	MR
1161	1163	1021

Controller

Controller	Operation method
SR1-X20-R RCX320 RCX221/222 RCX340	Programming / I/O point trace / Remote command / Operation using RS-232C communication
TS-X220-R	I/O point trace / Remote command
RDV-X220-RBR1	Pulse train control

Cable carrier for users

S type Standard cable carrier
 Note. Cannot pass more than 3 urethane hoses (φ6 × 4).
 Dimensions: 180mm width, 61mm depth, 58mm height, 114mm total height.

M type Optional cable carrier
 Space for optional cable for users.
 Dimensions: 180mm width, 86mm depth, 166mm height, 73mm cable space, 57mm cable space, 35mm cable space.

N18: Horizontal installation / Standard Cable carrier specification RH

Cross-section E-E
 Use M8 x 1.25 hex socket head bolt with length head bolt with length (under head) of 40mm or more.
 Dimensions: 179mm, 156mm, 58mm, 115mm, 114mm, 180mm, 22mm, 36mm, 14mm, 12mm, 50mm, 2-M5 x 0.8 Depth11, (Diameter or roller: φ20), (Note 9), 61mm, 65mm.

Cross-section of cable carrier
 Dimensions: 40mm, 14mm, φ6.5, φ8.2.

Detail of section F
 Dimensions: 7mm, 3.7mm, 2.5mm, 7.2mm, R1, R0.3.

Side View
 Dimensions: 181±/3: L-side origin position (181: When origin is on R side), 78±/1 (Note 1), Effective stroke L, 181±/3: R-side origin position (181: When origin is on L side), 190mm, 150mm, 98mm, 2-φ6H7 Depth10, 8-M8 x 1.25 Depth25, 168mm (Between knobs φ6H7 +0.02), (Note 7), Ground terminal for user (M4), 200mm, B x 200, C-φ9 Depth30 See cross-section E-E. (Note 2), 149mm, 2-φ10H7 Depth15 See cross-section E-E. (Note 5), D ±/0.02.

Note 1. Stop positions are determined by the mechanical stoppers at both ends.
 Note 2. When using φ9 holes for installation, do not use a washer, spring washer, etc. in the main unit.
 Note 3. When shipped from the factory, the horizontal model has the origin on the right side and the wall model has the origin on the left side. (This diagram shows the machine whose cable carrier taken out from right.)
 Note 4. If the model is a standard cable carrier specification, it is not possible to pass 3 or more φ6 × 4 urethane air hoses.
 Note 5. When using a φ10H7 hole, make sure that the pin does not go into deeper than as shown in the drawing.
 Note 6. Contact us for vertical installation.
 Note 7. For the robot with more than 2,100 stroke, a roller is installed to prevent the cable carrier hanging.
 Note 8. Weight of models with no brake. The weight of brake-attached models is 1 kg heavier than the models with no brake shown in the table.
 Note 9. Depending on the stroke and the operating conditions, the cable carrier bending radius might be larger, making it higher than the dimensions shown in the diagram.

Effective stroke	500	600	700	800	900	1000	1100	1200	1300	1400	1500	1600	1700	1800	1900	2000	2100	2200	2300	2400	2500
L	862	962	1062	1162	1262	1362	1462	1562	1662	1762	1862	1962	2062	2162	2262	2362	2462	2562	2662	2762	2862
A	131	81	131	81	131	81	131	81	131	81	131	81	131	81	131	81	131	81	131	81	131
B	3	4	4	5	5	6	6	7	7	8	8	9	9	10	10	11	11	12	12	13	13
C	8	10	10	12	12	14	14	16	16	18	18	20	20	22	22	24	24	26	26	28	28
D	650	750	850	950	1050	1150	1250	1350	1450	1550	1650	1750	1850	1950	2050	2150	2250	2350	2450	2550	2650
Weight (kg) ^{Note 8}	27	29	31	33	35	37	39	41	43	45	47	48	50	52	54	56	58	60	62	64	66

YA	Articulated robots
LCM	Linear conveyor modules
CX	Single-axis robots
Robomity	Multi-axis single-axis actuator
TRANSEVO	Compact single-axis robots
FLIP-X	Single-axis robots
PHASER	Linear motor single-axis robots
XY-X	Cartesian robots
YK-X	SCARA robots
YP-X	Pick & place robots
CLEAN	CLEAN robots
CONTROLLER	CONTROLLER
INFORMATION	INFORMATION
T type	T type
F type	F type
GF type	GF type
N type	N type
BR type	BR type

N18: Horizontal installation / Optional Cable carrier specification **RH**

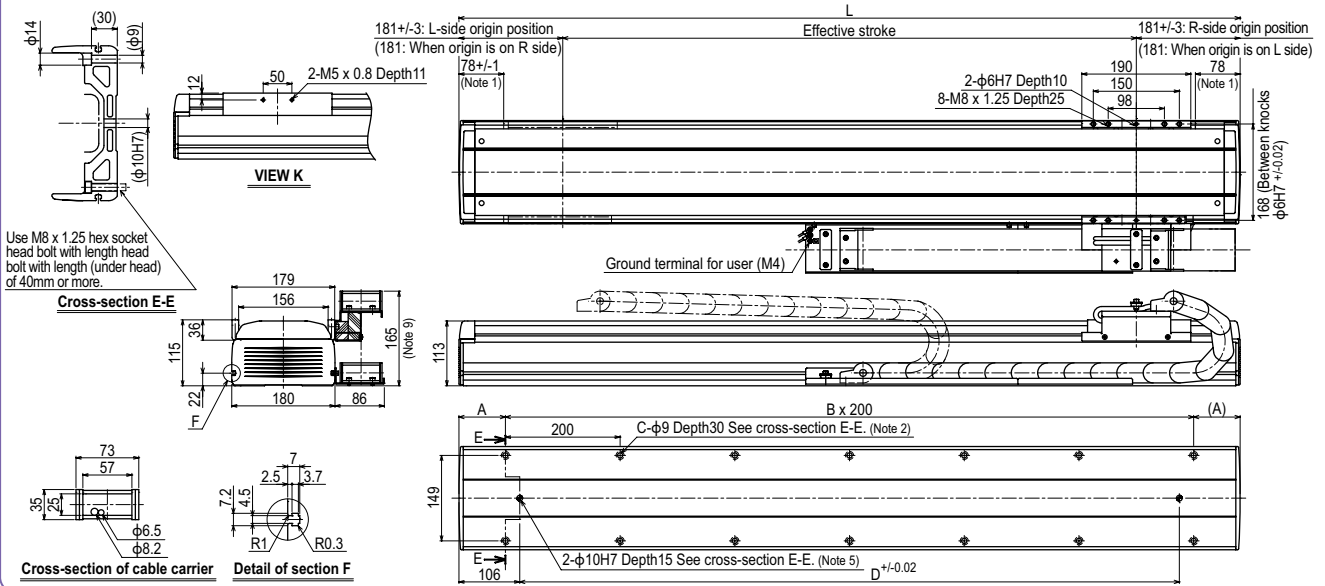

N18: Wall installation / Standard Cable carrier specification **RW**

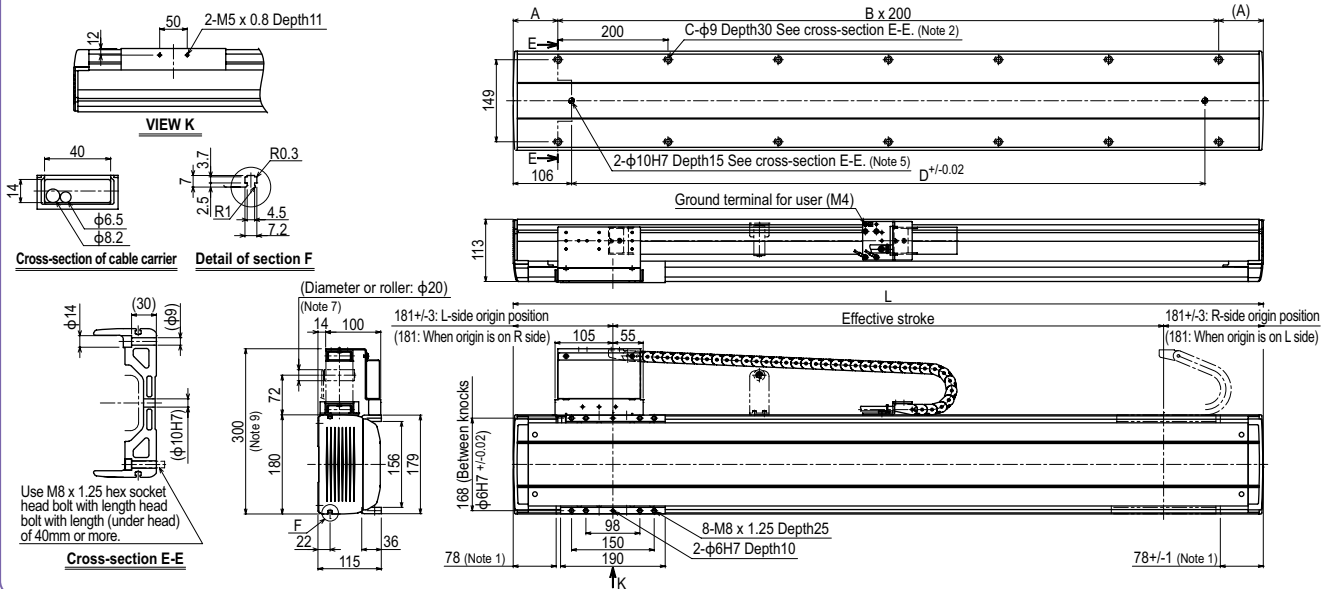

N18: Wall installation / Optional Cable carrier specification **RW**

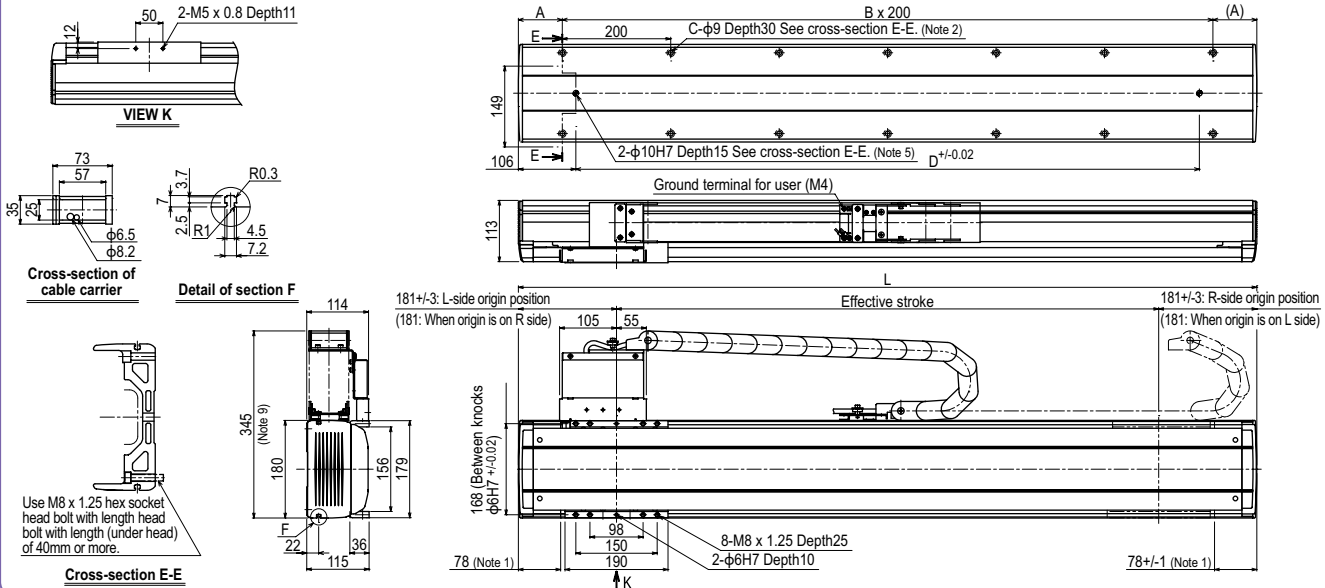

N18D

Double carriage

Ordering method

N18D - 20

Model	Lead designation	Installation direction	Cable carrier specification	Option	Stroke	Cable length	Controller ^{Note 1}
		H: Horizontal installation W: Wall installation	S: Standard Cable carrier M: Optional Cable carrier	Grease type None: Standard GC: Clean	250 to 2250 (100mm pitch)	3L: 3.5m 5L: 5m 10L: 10m 3K/5K/10K [Flexible cable] ^{Note 3}	RCX320 RCX222HP SR1-X (2 units) ^{Note 2} TS-X (2 units) ^{Note 2} RDV-X (2 units) ^{Note 2}

Note 1. To find controller selection options, see the ordering method on each controller page.

Note 2. 2 units are required when using SR1-X, TS-X or RDV-X.

Note 3. If a flexible cable is needed for the SR1-X, TS-X, or RDV-X, then select 3K/5K/10K. On the RCX320/RCX222HP, the standard cable is a flexible cable, so enter 3L/5L/10L when ordering.

Specifications

AC servo motor output (W)	400
Repeatability ^{Note 1} (mm)	+/-0.01
Deceleration mechanism	Ball screw $\phi 20$
Ball screw lead (mm)	20
Maximum speed ^{Note 2} (mm/sec)	1200
Maximum payload (kg)	80
Rated thrust (N)	339
Stroke (mm)	250 to 2250 (100 pitch)
Overall length (mm)	Stroke+362
Maximum dimensions of cross section of main unit (mm)	W180 x H115
Cable length (m)	Standard: 3.5 / Option: 5, 10
Linear guide type	4 rows of circular arc grooves x 2 rail
Position detector	Resolvers ^{Note 3}
Resolution (Pulse/rotation)	16384

Note 1. Positioning repeatability in one direction.

Note 2. The maximum speed may not be reached when the moving distance is short.

Note 3. Position detectors (resolvers) are common to incremental and absolute specifications. If the controller has a backup function then it will be absolute specifications.

Allowable overhang^{Note}

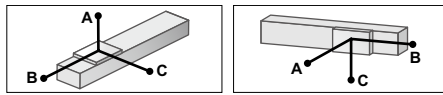

Horizontal installation	(Unit: mm)			Wall installation	(Unit: mm)		
	A	B	C		A	B	C
Lead 20	30kg 3045	1629	1902	Lead 20	30kg 1928	1553	3045
	50kg 2602	961	1150		50kg 1157	885	2602
	80kg 2193	586	716		80kg 707	509	2193

Note. Distance from center of slider top to center of gravity of object being carried at a guide service life of 10,000 km.

Cable carrier for users

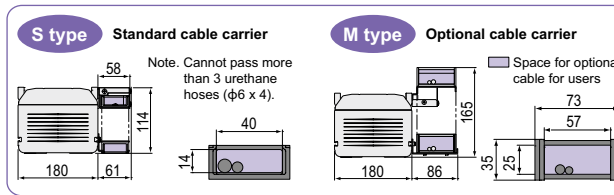

Static loading moment

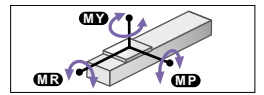

(Unit: N·m)		
MY	MP	MR
1161	1163	1021

Controller

Controller	Operation method
RCX320-R RCX222HP-R	Programming / I/O point trace / Remote command / Operation using RS-232C communication
SR1-X20-R ^{Note}	I/O point trace / Remote command
TS-X220-R ^{Note}	I/O point trace / Remote command
RDV-X20-RBR1 ^{Note}	Pulse train control

Note. 2 units are required when using SR1-X, TS-X or RDV-X.

N18D: Horizontal installation / Standard Cable carrier specification

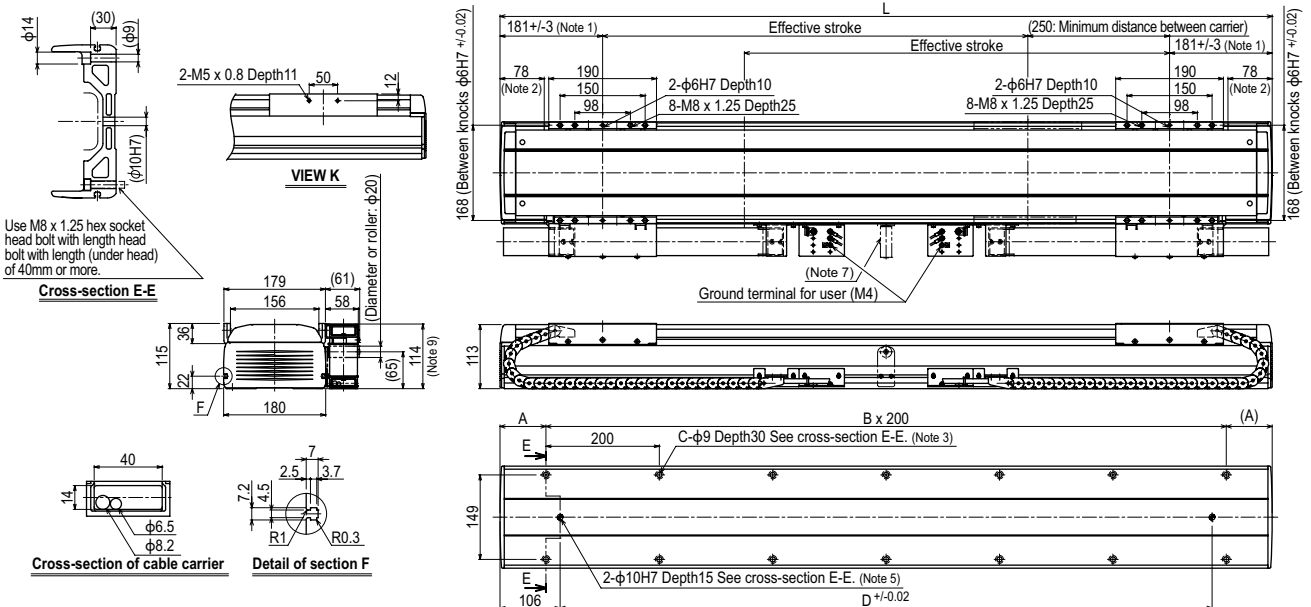

Note 1. Position of table carriage when searched to the origin.
Note 2. Stop positions are determined by the mechanical stoppers at both ends.
Note 3. When using $\phi 9$ holes for installation, do not use a washer, spring washer, etc. in the main unit.
Note 4. If the model is a standard cable carrier specification, it is not possible to pass 3 or more $\phi 6 \times 4$ urethane air hoses.
Note 5. When using a $\phi 10H7$ hole, make sure that the pin does not go into deeper than as shown in the drawing.
Note 6. Contact us for vertical installation.
Note 7. For the robot with more than 2,050 stroke, a roller to prevent the cable carrier from hanging is provided.
Note 8. Weight of models with no brake. The weight of brake-attached models is 1 kg heavier than the models with no brake shown in the table.
Note 9. Depending on the stroke and the operating conditions, the cable carrier bending radius might be larger, making it higher than the dimensions shown in the diagram.

Effective stroke	250	350	450	550	650	750	850	950	1050	1150	1250	1350	1450	1550	1650	1750	1850	1950	2050	2150	2250
L	862	962	1062	1162	1262	1362	1462	1562	1662	1762	1862	1962	2062	2162	2262	2362	2462	2562	2662	2762	2862
A	131	81	131	81	131	81	131	81	131	81	131	81	131	81	131	81	131	81	131	81	131
B	3	4	4	5	5	6	6	7	7	8	8	9	9	10	10	11	11	12	12	13	13
C	8	10	10	12	12	14	14	16	16	18	18	20	20	22	22	24	24	26	26	28	28
D	650	750	850	950	1050	1150	1250	1350	1450	1550	1650	1750	1850	1950	2050	2150	2250	2350	2450	2550	2650
Weight (kg) ^{Note 8}	35	37	39	41	43	45	47	48	50	52	54	56	58	60	62	64	66	68	70	72	74

Articulated robots
YA

Linear conveyor modules
LCM

Single-axis robots
CX

Multi-axis single axis actuator
Robotomy

Compact single-axis robots
TRANSERO

Single-axis robots
FLIP-X

Linear motor single-axis robots
PHASER

Cartesian robots
XY-X

SCARA robots
YK-X

Pick & place robots
YP-X

CLEAN

CONTROLLER

INFORMATION

T type

F type

GF type

N type

BR type

N18D: Horizontal installation / Optional Cable carrier specification

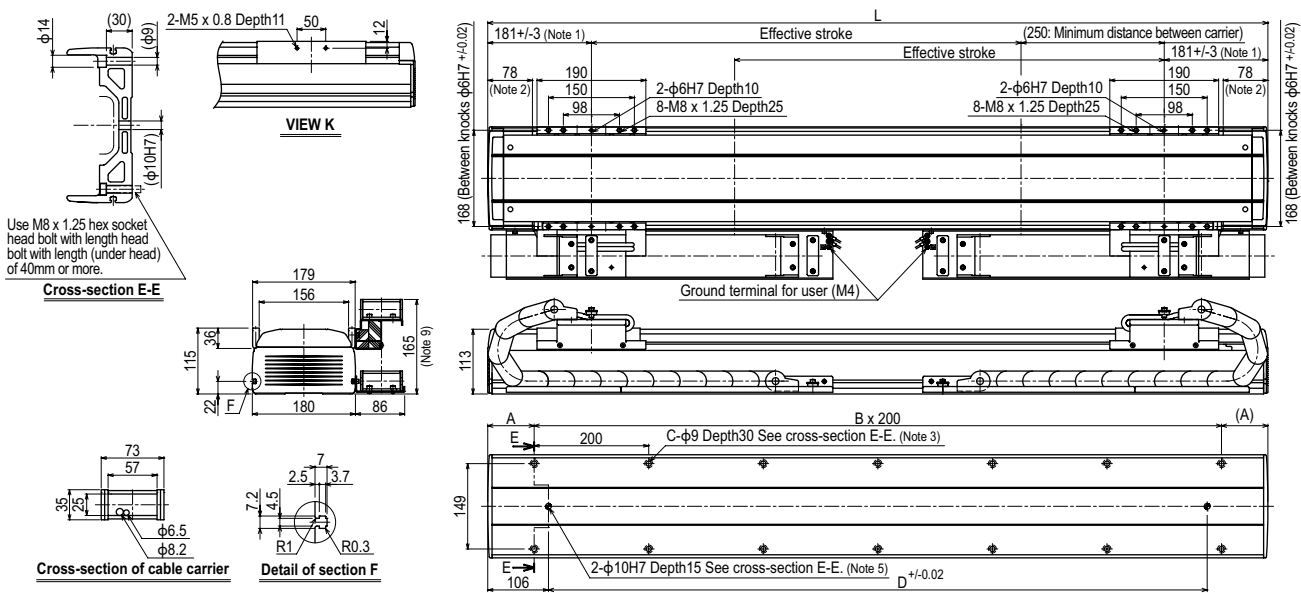

N18D: Wall installation / Standard Cable carrier specification

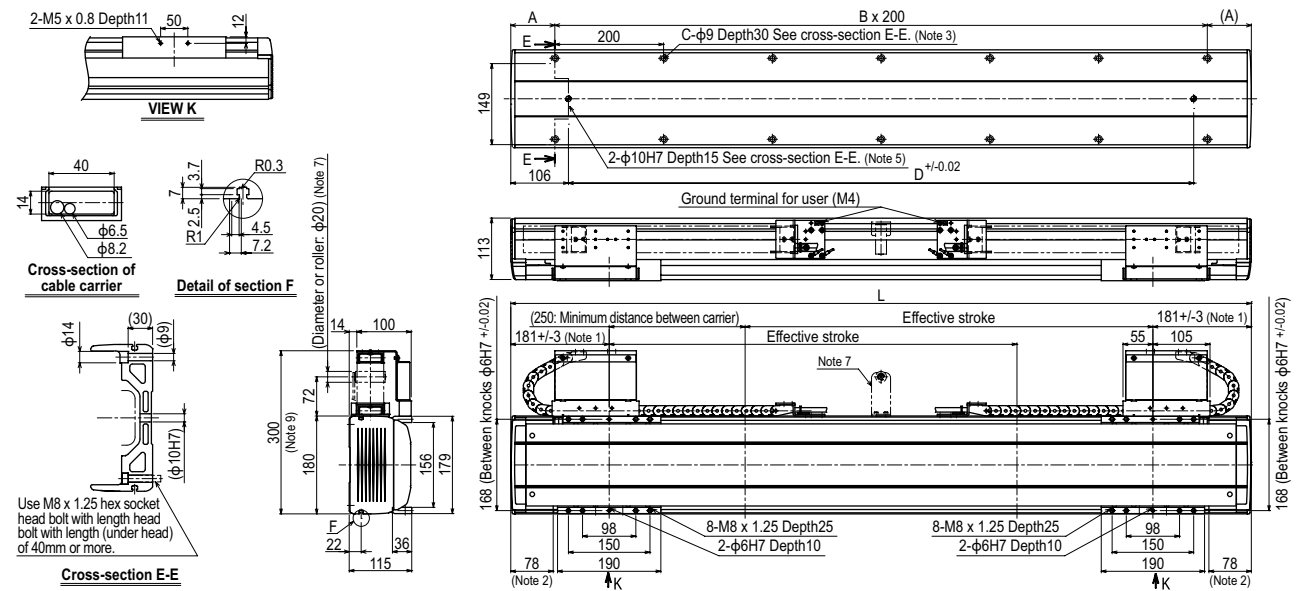

N18D: Wall installation / Optional Cable carrier specification

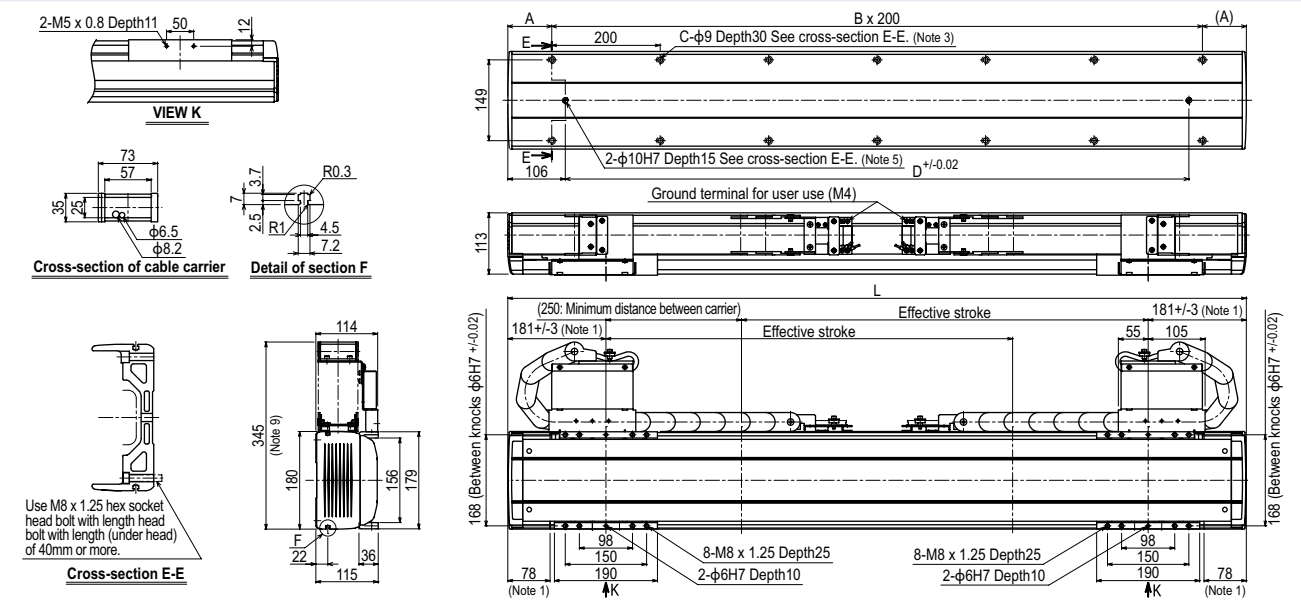

B10



Ordering method

B10

Model	Motor installation direction	Option	Stroke	Cable length ^{Note1}
	L: Motor leftward, horizontal position R: Motor rightward, horizontal position LU: Motor leftward, upper position RU: Motor rightward, upper position LD: Motor leftward, lower position RD: Motor rightward, lower position	Grease type None: Standard GC: Clean	150 to 2550 (100mm pitch)	3L: 3.5m 5L: 5m 10L: 10m 3K/5K/10K (Flexible cable)

TSX

Positioner ^{Note2} TSX: TS-X	Driver: Power-supply voltage / Power capacity 105: 100V/100W or less 205: 200V/100W or less	LCD monitor No entry: None L: With LCD	I/O selection NP: NPN PN: PNP CC: CC-Link DN: DeviceNet™ EP: EtherNet/IP™ PT: PROFINET GW: No I/O board ^{Note3}	Battery B: With battery (Absolute) N: None (Incremental)
--	---	--	---	--

SR1-X

Controller	05 Driver: Power capacity 05: 100W or less	Usable for CE No entry: Standard E: CE marking	I/O selection N: NPN P: PNP CC: CC-Link DN: DeviceNet™ PB: PROFIBUS	Battery B: With battery (Absolute) N: None (Incremental)
------------	--	--	--	--

RDV-X

Driver	2 Power-supply voltage 2: AC200V	05 Driver: Power capacity 05: 100W or less	RBR1 Regenerative unit
--------	--	--	---------------------------

Note 1. The robot cable is standard cable (3L/5L/10L), but can be changed to flexible cable.
See P.732 for details on robot cable.
Note 2. See P.634 for DIN rail mounting bracket.
Note 3. Select this selection when using the gateway function. For details, see P.96.

Specifications

AC servo motor output (W)	100
Repeatability ^{Note 1} (mm)	+/-0.04
Belt (mm)	Equivalent to lead 25
Maximum speed (mm/sec)	1875
Maximum payload (kg)	10
Stroke (mm)	150 to 2550 (100mm pitch)
Overall length (mm)	Motor installation L/R type Stroke+397.5 Another Stroke+310
Maximum dimensions of cross section of main unit (mm)	W100 × H81
Cable length (m)	Standard: 3.5 / Option: 5.10
Linear guide type	4 rows of circular arc grooves × 1 rail
Position detector	Resolvers ^{Note 2}
Resolution (Pulse/rotation)	16384

Note 1. Positioning repeatability in one direction.
Note 2. Position detectors (resolvers) are common to incremental and absolute specifications. If the controller has a backup function then it will be absolute specifications.

Allowable overhang^{Note}

	Horizontal installation (Unit: mm)			Wall installation (Unit: mm)		
	A	B	C	A	B	C
3kg	1800	1392	1084	1144	1005	1734
5kg	1574	826	696	724	576	1199
8kg	1221	509	474	493	333	918
10kg	1171	403	407	414	254	869

Note. Distance from center of slider top to center of gravity of object being carried at a guide service life of 10,000 km.

Static loading moment

(Unit: N·m)		
MY	MP	MR
188	188	165

Controller

Controller	Operation method
SR1-X05 RCX320 RCX221/222 RCX340	Programming / I/O point trace / Remote command / Operation using RS-232C communication
TS-X105 TS-X205	I/O point trace / Remote command
RDV-X205-RBR1	Pulse train control

Motor installation The line-up consisting of six models of different motor installation position as follows.

L type Leftward at horizontal position	R type Rightward at horizontal position	LU type Leftward at upper position	RU type Rightward at upper position	LD type Leftward at lower position	RD type Rightward at lower position
---	--	---	--	---	--

B10 R type (Motor rightward, horizontal position)

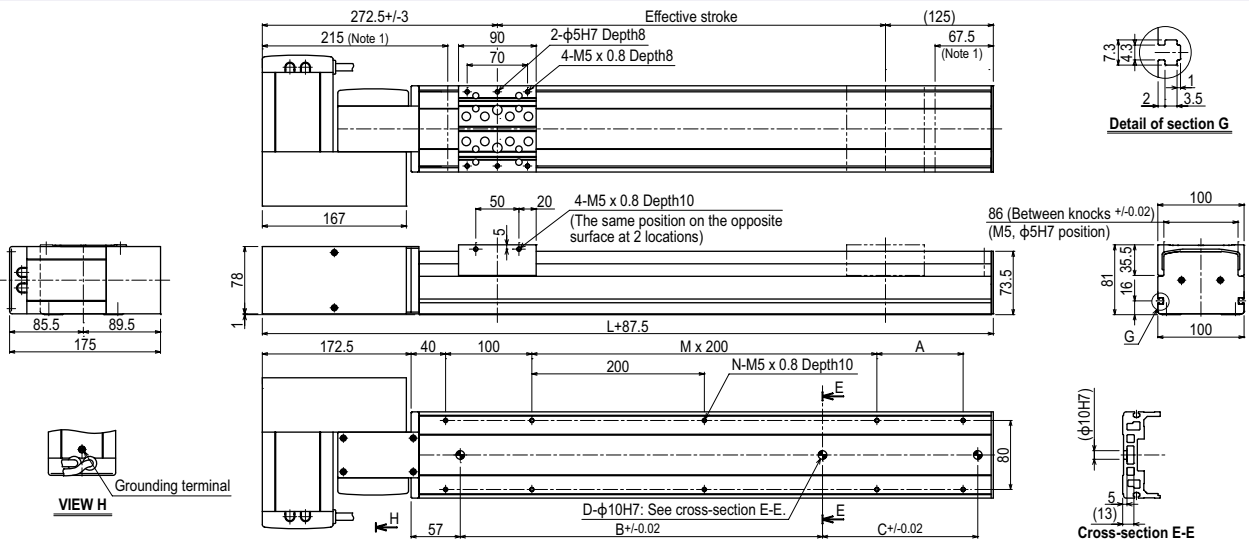

Effective stroke	150	200	250	300	350	400	450	500	550	600	650	700	750	800	850	900	950	1000	1050	1100	1150	1200	1250	1300	1350
L	460	510	560	610	660	710	760	810	860	910	960	1010	1060	1110	1160	1210	1260	1310	1360	1410	1460	1510	1560	1610	1660
A	200	50	100	150	200	50	100	150	200	50	100	150	200	50	100	150	200	50	100	150	200	50	100	150	200
B	240	240	240	420	420	420	600	600	600	600	780	780	780	780	960	960	960	960	1140	1140	1140	1140	1320	1320	1320
C	-	-	-	-	-	-	-	-	-	-	-	-	-	-	-	-	-	-	-	-	-	-	-	-	-
D	2	2	2	2	2	2	2	2	2	2	2	2	2	2	2	2	2	2	2	2	2	2	2	2	2
M	-	1	1	1	1	1	2	2	2	2	3	3	3	3	4	4	4	5	5	5	5	6	6	6	6
N	6	8	8	8	8	10	10	10	10	12	12	12	12	14	14	14	14	16	16	16	16	18	18	18	18
Weight (kg)	7.4	7.8	8.2	8.6	9.0	9.4	9.8	10.1	10.5	10.9	11.3	11.7	12.1	12.5	12.9	13.3	13.7	14.1	14.5	14.9	15.3	15.7	16.1	16.5	16.9

Effective stroke	1400	1450	1500	1550	1600	1650	1700	1750	1800	1850	1900	1950	2000	2050	2100	2150	2200	2250	2300	2350	2400	2450	2500	2550
L	1710	1760	1810	1860	1910	1960	2010	2060	2110	2160	2210	2260	2310	2360	2410	2460	2510	2560	2610	2660	2710	2760	2810	2860
A	50	100	150	200	50	100	150	200	50	100	150	200	50	100	150	200	50	100	150	200	50	100	150	200
B	1320	1320	1320	1320	1320	1320	1320	1320	1320	1320	1320	1320	1320	1320	1320	1320	1320	1320	1320	1320	1320	1320	1320	1320
C	-	240	240	240	420	420	420	600	600	600	600	780	780	780	780	960	960	960	960	1140	1140	1140	1140	1320
D	2	3	3	3	3	3	3	3	3	3	3	3	3	3	3	3	3	3	3	3	3	3	3	3
M	7	7	7	7	8	8	8	8	9	9	9	9	10	10	10	10	11	11	11	11	11	12	12	12
N	20	20	20	20	22	22	22	22	24	24	24	24	26	26	26	26	28	28	28	28	28	30	30	30
Weight (kg)	17.3	17.7	18.0	18.4	18.8	19.2	19.6	20.0	20.4	20.8	21.2	21.6	22.0	22.4	22.8	23.2	23.6	24.0	24.4	24.8	25.2	25.6	25.9	26.3

Note 1. Stop positions are determined by the mechanical stoppers at both ends.
Note 2. Cables can be extracted in upward, downward, forward or rearward directions. (This figure shows the forward direction.)

Articulated robots
YA

Linear conveyor modules
LCM

Single-axis robots
CX

Motor-less single axis actuator
Robomity

Compact single-axis robots
TRANSERO

Single-axis robots
FLIP-X

Linear motor single-axis robots
PHASER

Cartesian robots
XY-X

SCARA robots
YK-X

Pick & place robots
YP-X

CLEAN

CONTROLLER

INFORMATION

T type

F type

GF type

N type

B type

B10 RU type (Motor rightward, upper position)

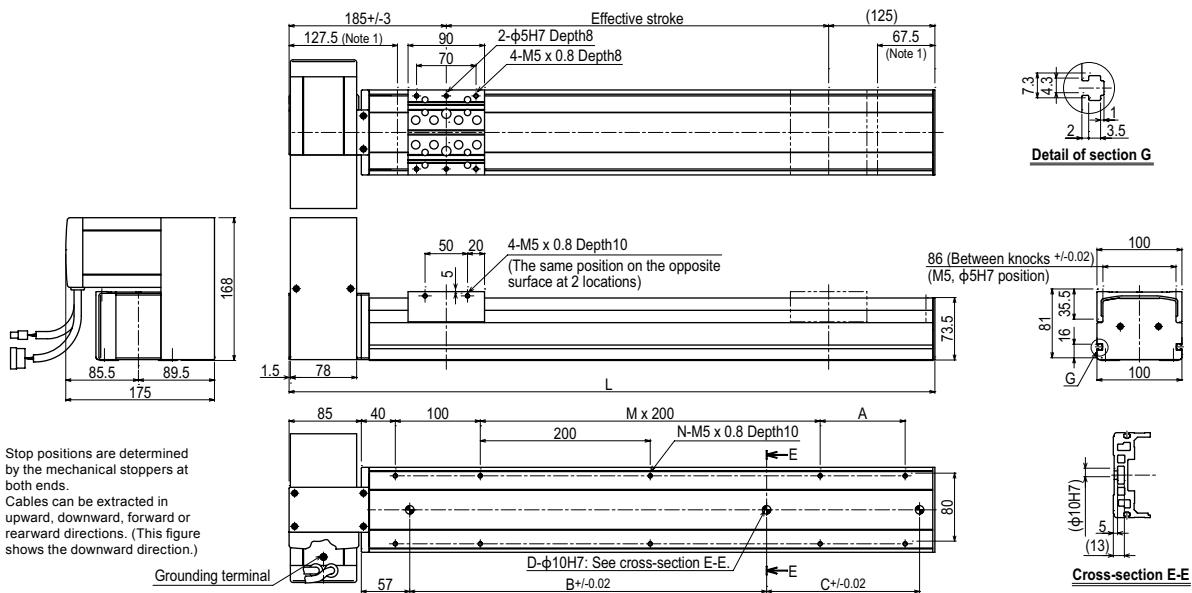

Note 1. Stop positions are determined by the mechanical stoppers at both ends.

Note 2. Cables can be extracted in upward, downward, forward or rearward directions. (This figure shows the downward direction.)

B10 RD type (Motor rightward, lower position)

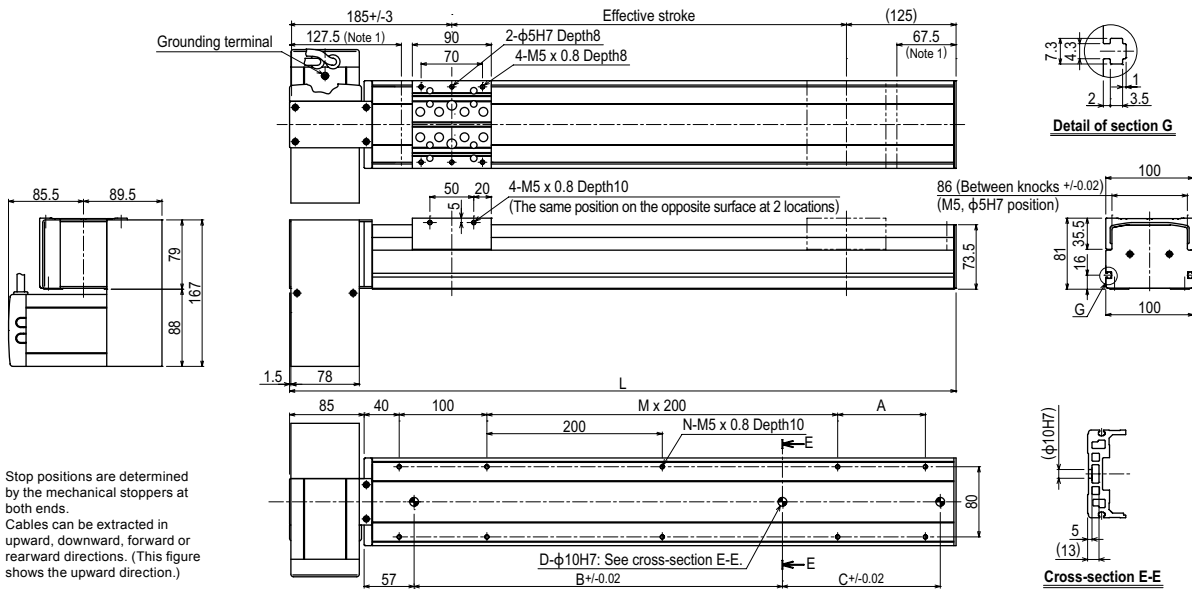

Note 1. Stop positions are determined by the mechanical stoppers at both ends.

Note 2. Cables can be extracted in upward, downward, forward or rearward directions. (This figure shows the upward direction.)

B10 LU type (Motor leftward, upper position)

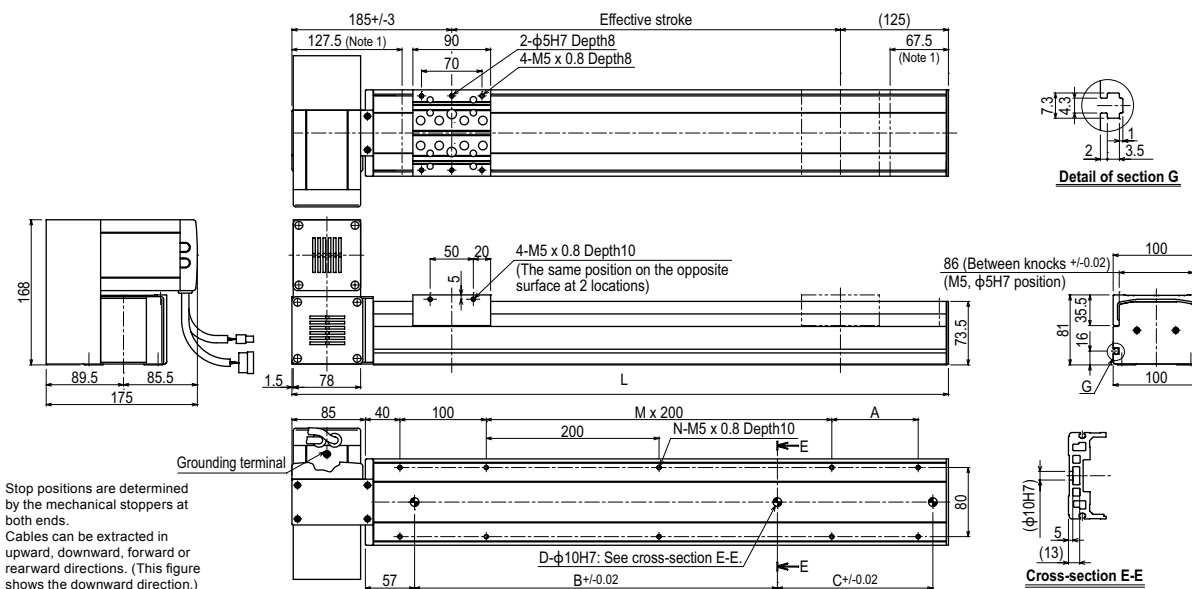

Note 1. Stop positions are determined by the mechanical stoppers at both ends.

Note 2. Cables can be extracted in upward, downward, forward or rearward directions. (This figure shows the downward direction.)

B14



Ordering method

B14	Model	Motor installation direction L: Motor leftward, horizontal position R: Motor rightward, horizontal position LU: Motor leftward, upper position RU: Motor rightward, upper position LD: Motor leftward, lower position RD: Motor rightward, lower position	Option Grease type None: Standard GC: Clean	Stroke 150 to 3050 (50mm pitch)	Cable length^{Note 1} 3L: 3.5m 5L: 5m 10L: 10m 3K/5K/10K (Flexible cable)	TSX Positioner ^{Note 2} TSX: TS-X	Driver: Power-supply voltage / Power capacity 105: 100V/100W or less 205: 200V/100W or less	LCD monitor No entry: None L: With LCD	I/O selection NP: NPN PN: PNP CC: CC-Link DN: DeviceNet™ EP: EtherNet/IP™ PT: PROFINET GW: No I/O board ^{Note 3}	Battery B: With battery (Absolute) N: None (Incremental)
	SR1-X	Controller	05	Driver: Power capacity 05: 100W or less	Usable for CE No entry: Standard E: CE marking	I/O selection N: NPN P: PNP CC: CC-Link DN: DeviceNet™ PB: PROFIBUS	Battery B: With battery (Absolute) N: None (Incremental)			
	RDV-X	Driver	2	Power-supply voltage 2: AC200V	05	Driver: Power capacity 05: 100W or less	RBR1	Regenerative unit		

Note 1. The robot cable is standard cable (3L/5L/10L), but can be changed to flexible cable.
See P.732 for details on robot cable.
Note 2. See P.634 for DIN rail mounting bracket.
Note 3. Select this selection when using the gateway function. For details, see P.96.

Specifications

AC servo motor output (W)	100
Repeatability ^{Note 1} (mm)	+/-0.04
Belt (mm)	Equivalent to lead 25mm
Maximum speed (mm/sec)	1875
Maximum payload (kg)	20
Stroke (mm)	150 to 3050 (100mm pitch)
Overall length (mm)	Motor installation L/R type Stroke+425.5 Another Stroke+338
Maximum dimensions of cross section of main unit (mm)	W146 × H94
Cable length (m)	Standard: 3.5 / Option: 5.10
Linear guide type	4 rows of circular arc grooves × 2 rail
Position detector	Resolvers ^{Note 2}
Resolution (Pulse/rotation)	16384

Note 1. Positioning repeatability in one direction.
Note 2. Position detectors (resolvers) are common to incremental and absolute specifications. If the controller has a backup function then it will be absolute specifications.

Allowable overhang^{Note}

	Horizontal installation (Unit: mm)			Wall installation (Unit: mm)		
	A	B	C	A	B	C
5kg	2159	1228	943	1064	816	1468
10kg	1389	623	548	564	377	888
20kg	1102	320	348	305	156	615

Note. Distance from center of slider top to center of gravity of object being carried at a guide service life of 10,000 km.

Static loading moment

(Unit: N·m)		
MY	MP	MR
226	227	199

Controller

Controller	Operation method
SR1-X05 RCX320 RCX221/222 RCX340	Programming / I/O point trace / Remote command / Operation using RS-232C communication
TS-X105 TS-X205	I/O point trace / Remote command
RDV-X205-RBR1	Pulse train control

Motor installation The line-up consisting of six models of different motor installation position as follows.

L type Leftward at horizontal position	R type Rightward at horizontal position	LU type Leftward at upper position	RU type Rightward at upper position	LD type Leftward at lower position	RD type Rightward at lower position
---	--	---	--	---	--

B14 R type (Motor rightward, horizontal position)

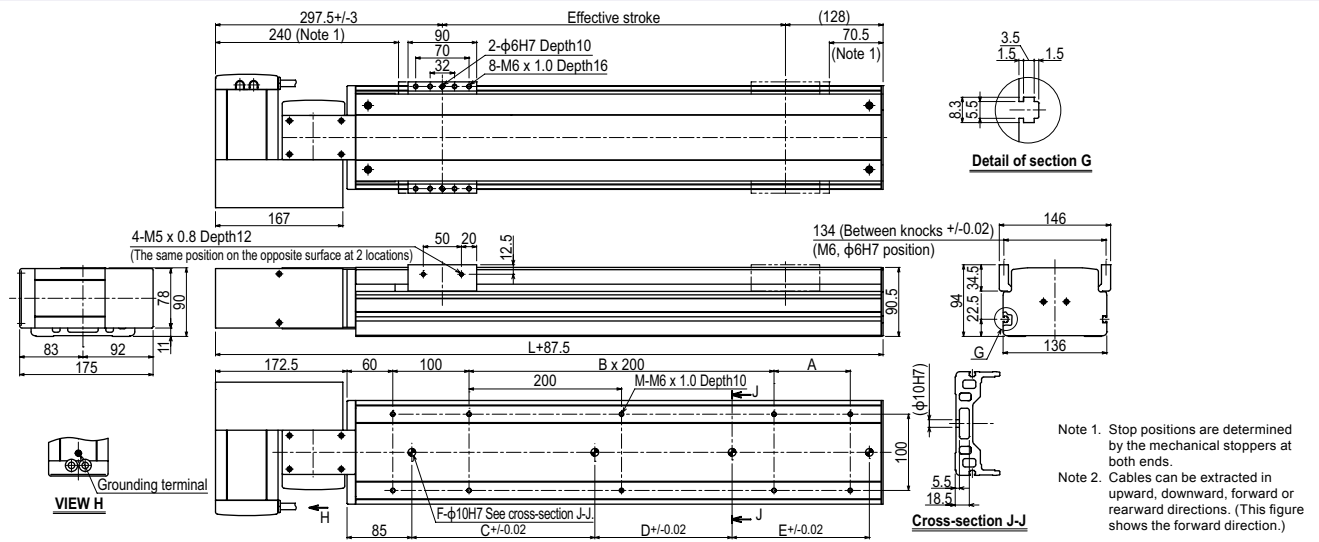

Note 1. Stop positions are determined by the mechanical stoppers at both ends.
Note 2. Cables can be extracted in upward, downward, forward or rearward directions. (This figure shows the forward direction.)

Effective stroke	150	200	250	300	350	400	450	500	550	600	650	700	750	800	850	900	950	1000	1050	1100	1150	1200	1250	1300	1350	1400	1450	1500	1550	1600
L	488	538	588	638	688	738	788	838	888	938	988	1038	1088	1138	1188	1238	1288	1338	1388	1438	1488	1538	1588	1638	1688	1738	1788	1838	1888	1938
M	6	8	8	8	8	10	10	10	10	12	12	12	12	14	14	14	16	16	16	16	18	18	18	18	20	20	20	20	22	
A	-	50	100	150	200	50	100	150	200	50	100	150	200	50	100	150	200	50	100	150	200	50	100	150	200	50	100	150	200	50
B	1	1	1	1	1	2	2	2	2	3	3	3	3	4	4	4	5	5	5	5	6	6	6	6	7	7	7	7	8	
C	240	240	240	420	420	420	600	600	600	600	780	780	780	780	960	960	960	1140	1140	1140	1140	1140	1140	1140	1140	1140	1140	1140	1140	1140
D	-	-	-	-	-	-	-	-	-	-	-	-	-	-	-	-	-	-	-	-	-	-	240	240	240	240	420	420	420	600
E	-	-	-	-	-	-	-	-	-	-	-	-	-	-	-	-	-	-	-	-	-	-	-	-	-	-	-	-	-	-
F	2	2	2	2	2	2	2	2	2	2	2	2	2	2	2	2	2	2	2	2	2	2	2	2	2	2	2	2	2	2
Weight (kg)	9.6	10.2	10.8	11.4	12	12.5	13.1	13.7	14.3	14.9	15.5	16.0	16.6	17.2	17.8	18.4	19	19.5	20.2	20.7	21.3	21.9	22.5	23.1	23.7	24.2	24.8	25.4	26	26.6

Effective stroke	1650	1700	1750	1800	1850	1900	1950	2000	2050	2100	2150	2200	2250	2300	2350	2400	2450	2500	2550	2600	2650	2700	2750	2800	2850	2900	2950	3000	3050	
L	1988	2038	2088	2138	2188	2238	2288	2338	2388	2438	2488	2538	2588	2638	2688	2738	2788	2838	2888	2938	2988	3038	3088	3138	3188	3238	3288	3338	3388	
M	22	22	22	24	24	24	26	26	26	26	28	28	28	28	28	30	30	30	30	32	32	32	34	34	34	34	34	36	36	
A	100	150	200	50	100	150	200	50	100	150	200	50	100	150	200	50	100	150	200	50	100	150	200	50	100	150	200	50	100	
B	8	8	8	9	9	9	10	10	10	10	11	11	11	11	12	12	12	12	13	13	13	13	14	14	14	14	14	15	15	
C	1140	1140	1140	1140	1140	1140	1140	1140	1140	1140	1140	1140	1140	1140	1140	1140	1140	1140	1140	1140	1140	1140	1140	1140	1140	1140	1140	1140	1140	1140
D	600	600	600	780	780	780	780	960	960	960	960	1140	1140	1140	1140	1140	1140	1140	1140	1140	1140	1140	1140	1140	1140	1140	1140	1140	1140	1140
E	-	-	-	-	-	-	-	-	-	-	-	-	-	-	-	240	240	240	240	420	420	420	420	600	600	600	780	780	780	
F	3	3	3	3	3	3	3	3	3	3	3	3	3	3	3	4	4	4	4	4	4	4	4	4	4	4	4	4	4	
Weight (kg)	27.2	27.7	28.3	28.9	29.5	30.1	30.7	31.3	31.9	32.4	33	33.6	34.2	34.8	35.4	35.9	36.5	37.1	37.7	38.3	38.9	39.4	40	40.6	41.2	41.8	42.4	43.0	43.6	

B14 RU type (Motor rightward, upper position)

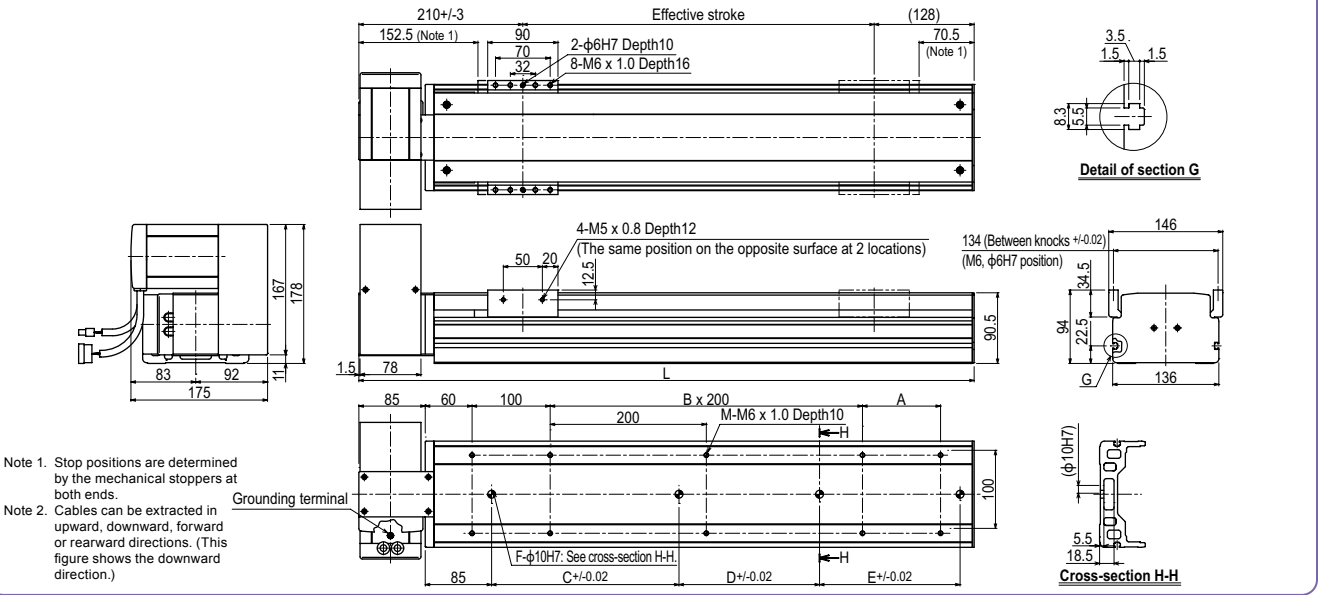

B14 RD type (Motor rightward, lower position)

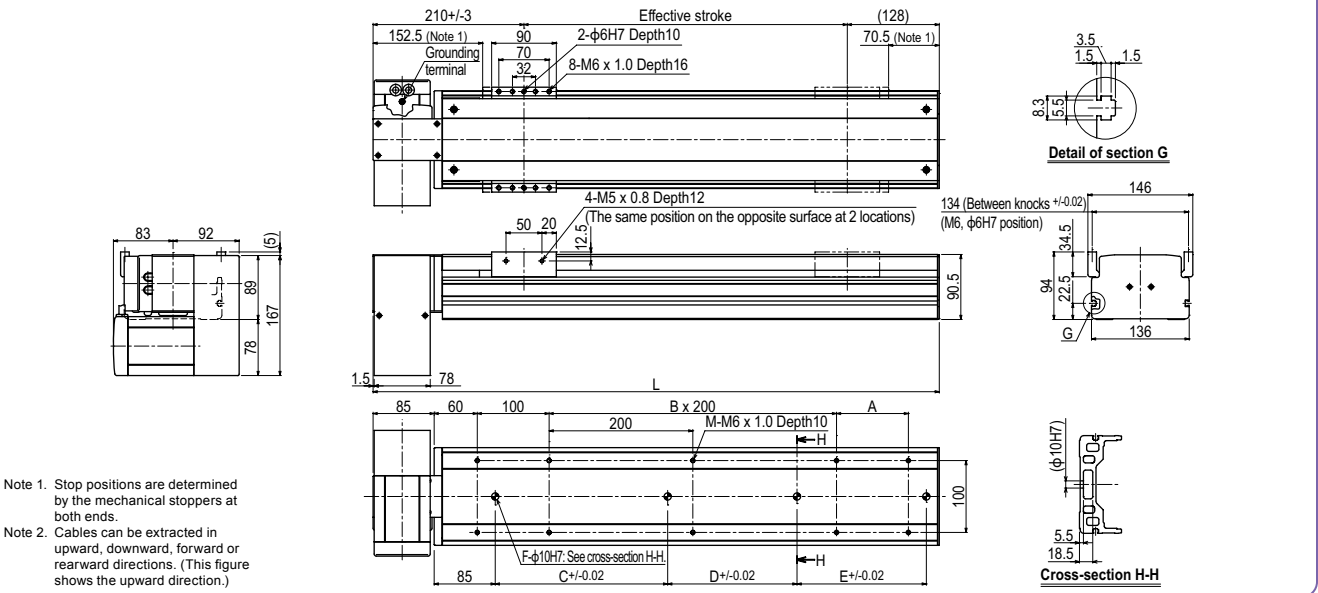

B14 LU type (Motor leftward, upper position)

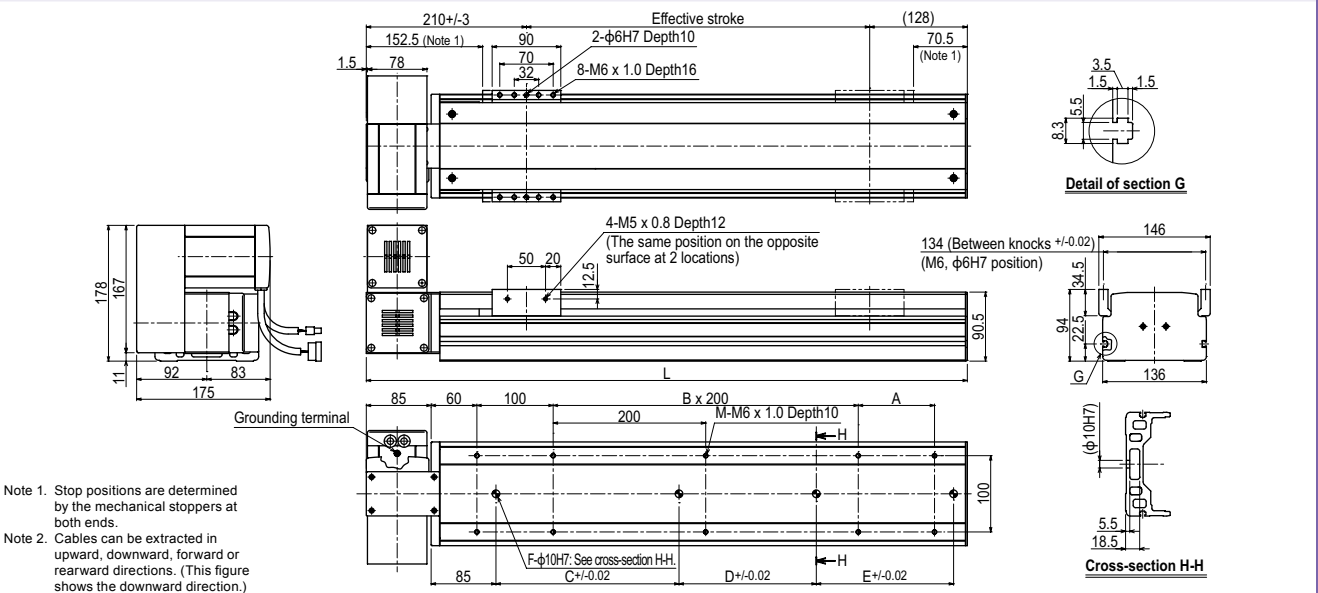

YA	Articulated robots
LCM	Linear conveyor modules
CX	Single-axis robots
Robonity	Motor-less single axis actuator
TRANSERO	Compact single-axis robots
FLIP-X	Single-axis robots
PHASER	Linear motor single-axis robots
XY-X	Cartesian robots
YK-X	SCARA robots
YP-X	Pick & place robots
CLEAN	Clean robots
CONTROLLER	Controller
INFORMATION	Information
T type	T type
F type	F type
GF type	GF type
N type	N type
B type	B type

B14H RU type (Motor rightward, upper position)

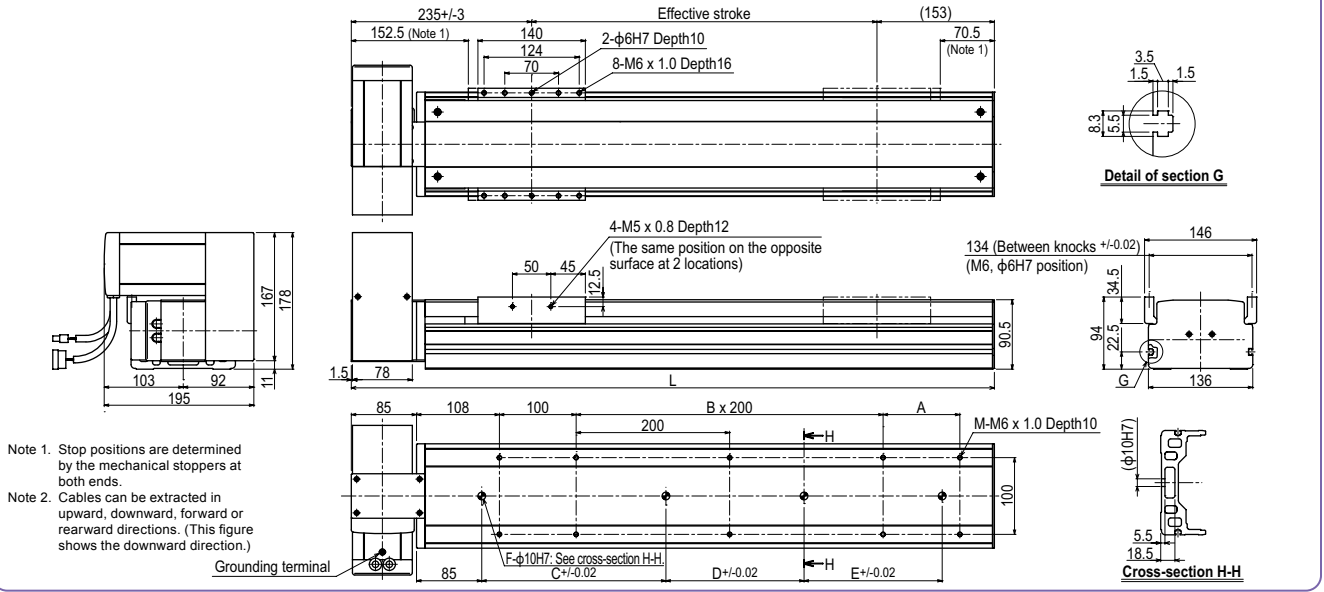

B14H RD type (Motor rightward, lower position)

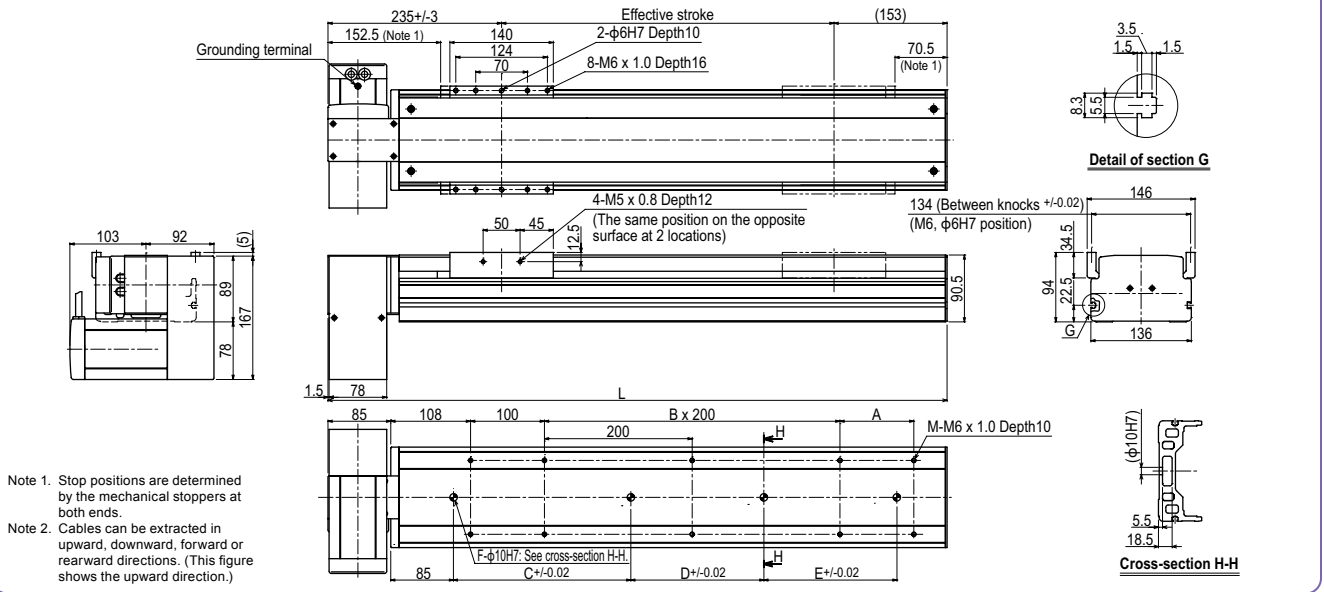

B14H LU type (Motor leftward, upper position)

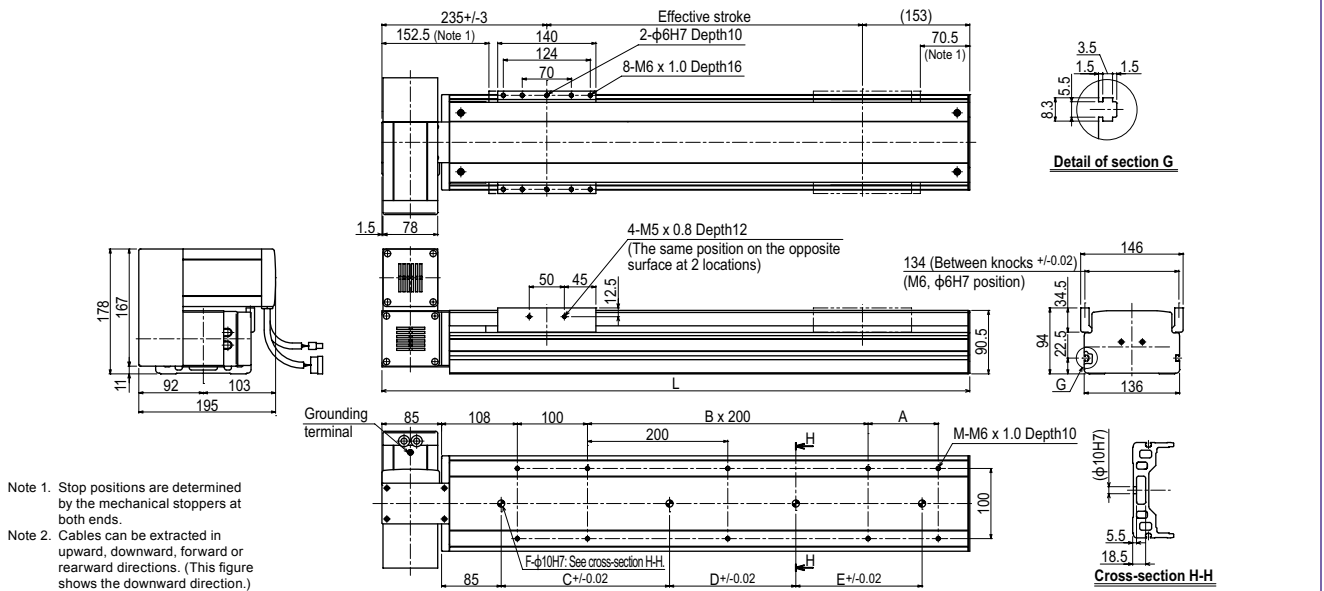

Articulated robots
YA

Linear conveyor modules
LCM

Single-axis robots
CX

Multi-axis single-axis actuator
Robotomy

Compact single-axis robots
TRANSEVO

Single-axis robots
FLIP-X

Linear motor single-axis robots
PHASER

Cartesian robots
XY-X

SCARA robots
YK-X

Pick & place robots
YP-X

CLEAN

CONTROLLER

INFORMATION

T type

F type

GF type

N type

B type

R10



Ordering method

R10	Model	Cable entry location No entry: Standard (S) B: From the side	Cable length ^{Note 1} 3L: 3.5m 5L: 5m 10L: 10m 3K/5K/10K (Flexible cable)	TSX	Positioner ^{Note 2} TSX: TS-X	Driver: Power-supply voltage / Power capacity 105: 100V/100W or less 205: 200V/100W or less	LCD monitor No entry: None L: With LCD	I/O selection NP: NPN PN: PNP CC: CC-Link DN: DeviceNet™ EP: EtherNet/IP™ PT: PROFINET GW: No I/O board ^{Note 3}	Battery B: With battery (Absolute) N: None (Incremental)
	SR1-X	Controller	05	Driver: Power capacity 05: 100W or less	Usable for CE No entry: Standard E: CE marking	I/O selection N: NPN P: PNP CC: CC-Link DN: DeviceNet™ PB: PROFIBUS	Battery B: With battery (Absolute) N: None (Incremental)		
	RDV-X	Driver	2	Power-supply voltage 2: AC200V	05	Driver: Power capacity 05: 100W or less	RBR1	Regenerative unit	

Note 1. The robot cable is standard cable (3L/5L/10L), but can be changed to flexible cable.
See P.732 for details on robot cable.
Note 2. See P.634 for DIN rail mounting bracket.
Note 3. Select this selection when using the gateway function. For details, see P.96.

Specifications

AC servo motor output (W)	100
Repeatability (°)	+/-0.0083
Maximum speed (°/sec)	360
Maximum allowable moment inertia (kgm ² [kgfcm ²])	0.36 [3.71]
Rated torque (Nm[kgfm])	10.78 [1.10]
Speed reduction ratio	1/50
Rotation range (°)	360
Cable length (m)	Standard: 3.5 / Option: 5,10
Speed reducer type	Harmonic drive
Position detector	Resolvers
Resolution (Pulse/rotation)	16384

Maximum allowable moment inertia

Payload parameters W (kg)	1	2	3	4	5	6	7	8	9	10
Maximum allowable moment inertia J (kgfcm ²)	0.25	0.49	0.74	0.99	1.24	1.48	1.73	1.98	2.23	2.47
Payload parameters W (kg)	11	12	13	14	15					
Maximum allowable moment inertia J (kgfcm ²)	2.72	2.97	3.22	3.46	3.71					

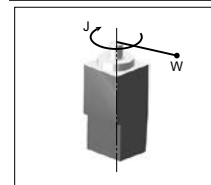

Note. When the weight of a tool or workpiece attached to the shaft R10 is W (kg), its moment of inertia (J) must be smaller than the values shown in the table above. (For example, enter 4kg if W is 3kg and J is 0.99kgf cm sec²). Enter the above mass parameter value for the controller, and optimum acceleration is automatically set based on this value.

Note. For calculation (equation) of the inertia moment, please refer to P.746.

Controller

Controller	Operation method
SR1-X05 RCX320 RCX221/222 RCX340	Programming / I/O point trace / Remote command / Operation using RS-232C communication
TS-X105 TS-X205	I/O point trace / Remote command
RDV-X205-RBR1	Pulse train control

R10

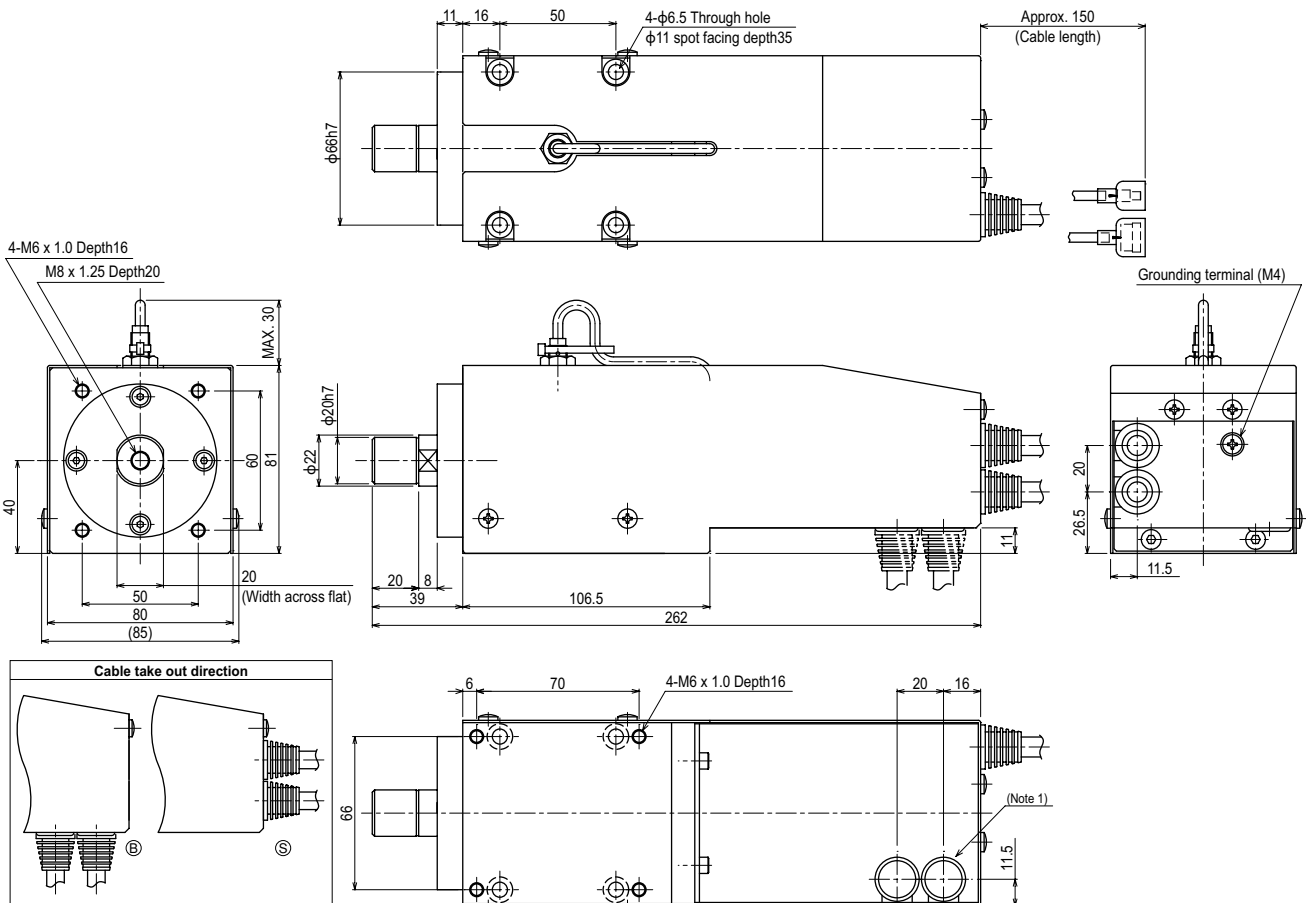

Weight (kg) 3.5

Note 1. The cable extraction port can be changed.

Articulated robots
YA

Linear conveyor modules
LCM

Single-axis robots
CX

Multi-axis single axis actuator
Robotomy

Compact single-axis robots
TRANSEVO

Single-axis robots
FLIP-X

Linear motor single-axis robots
PHASER

Cartesian robots
XY-X

SCARA robots
YK-X

Pick & place robots
YP-X

CLEAN

CONTROLLER INFORMATION

T type

F type

GF type

N type

R type

R20



Ordering method

R20	Model	Cable entry location No entry: Standard (S) B: From the side	Cable length ^{Note 1} 3L: 3.5m 5L: 5m 10L: 10m 3K/5K/10K (Flexible cable)	TSX	Driver: Power-supply voltage / Power capacity 110: 100V/200W or less 210: 200V/200W or less	LCD monitor No entry: None L: With LCD	I/O selection NP: NPN PN: PNP CC: CC-Link DN: DeviceNet™ EP: EtherNet/IP™ PT: PROFINET GW: No I/O board ^{Note 3}	Battery B: With battery (Absolute) N: None (Incremental)
	SR1-X	Controller	Driver: Power capacity 10: 200W or less	Usable for CE No entry: Standard E: CE marking	I/O selection N: NPN P: PNP CC: CC-Link DN: DeviceNet™ PB: PROFIBUS	Battery B: With battery (Absolute) N: None (Incremental)		
	RDV-X	Driver	Power-supply voltage 2: AC200V	10	Driver: Power capacity 10: 200W or less	RBR1	Regenerative unit	

Note 1. The robot cable is standard cable (3L/5L/10L), but can be changed to flexible cable. See P.732 for details on robot cable.
Note 2. See P.634 for DIN rail mounting bracket.
Note 3. Select this selection when using the gateway function. For details, see P.96.

Specifications

AC servo motor output (W)	200
Repeatability (°)	+/-0.0083
Maximum speed (°/sec)	360
Maximum allowable moment inertia (kgm²[kgfcm²])	1.83 [18.7]
Rated torque (Nm[kgfm])	21.46 [2.19]
Speed reduction ratio	1/50
Rotation range (°)	360
Cable length (m)	Standard: 3.5 / Option: 5,10
Speed reducer type	Harmonic drive
Position detector	-
Resolution (Pulse/rotation)	16384

Maximum allowable moment inertia

Payload parameters W (kg)	1	2	3	4	5	6	7	8	9	10
Maximum allowable moment inertia J (kgfcm²)	0.93	1.8	2.8	3.7	4.6	5.6	6.5	7.4	8.4	9.3

Payload parameters W (kg)	11	12	13	14	15	16	17	18	19	20
Maximum allowable moment inertia J (kgfcm²)	10.2	11.2	12.1	13.1	14	14.9	15.9	16.8	17.7	18.7

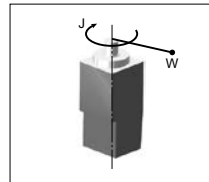

Note. When the weight of a tool or workpiece attached to the shaft R20 is W (kg), its moment of inertia (J) must be smaller than the values shown in the table above. (For example, enter 4kg if W is 3kg and J is 3.7kgf cm sec².) Enter the above mass parameter value for the controller, and optimum acceleration is automatically set based on this value.

Note. For calculation (equation) of the inertia moment, please refer to P.746.

Controller

Controller	Operation method
SR1-X10	Programming / I/O point trace / Remote command / Operation using RS-232C communication
RCX320	
RCX221/222	
RCX340	
TS-X110	I/O point trace / Remote command
TS-X210	Remote command
RDV-X210-RBR1	Pulse train control

R20

