

Top cowl A

Yellow (double strand 7/0) : 1

| Rows | Stitches |
|------|----------|
| 90 | 38 |
| ⋮ | ⋮ |
| 69 | 38 |
| 68 | 38(+2) |
| 67 | 36 |
| ⋮ | ⋮ |
| 47 | 36 |
| 46 | 36(+2) |
| 45 | 34 |
| ⋮ | ⋮ |
| 24 | 34 |
| 23 | 34(+2) |
| 22 | 32 |
| ⋮ | ⋮ |
| 1 | 32 |

*Starter ch 32 stitches

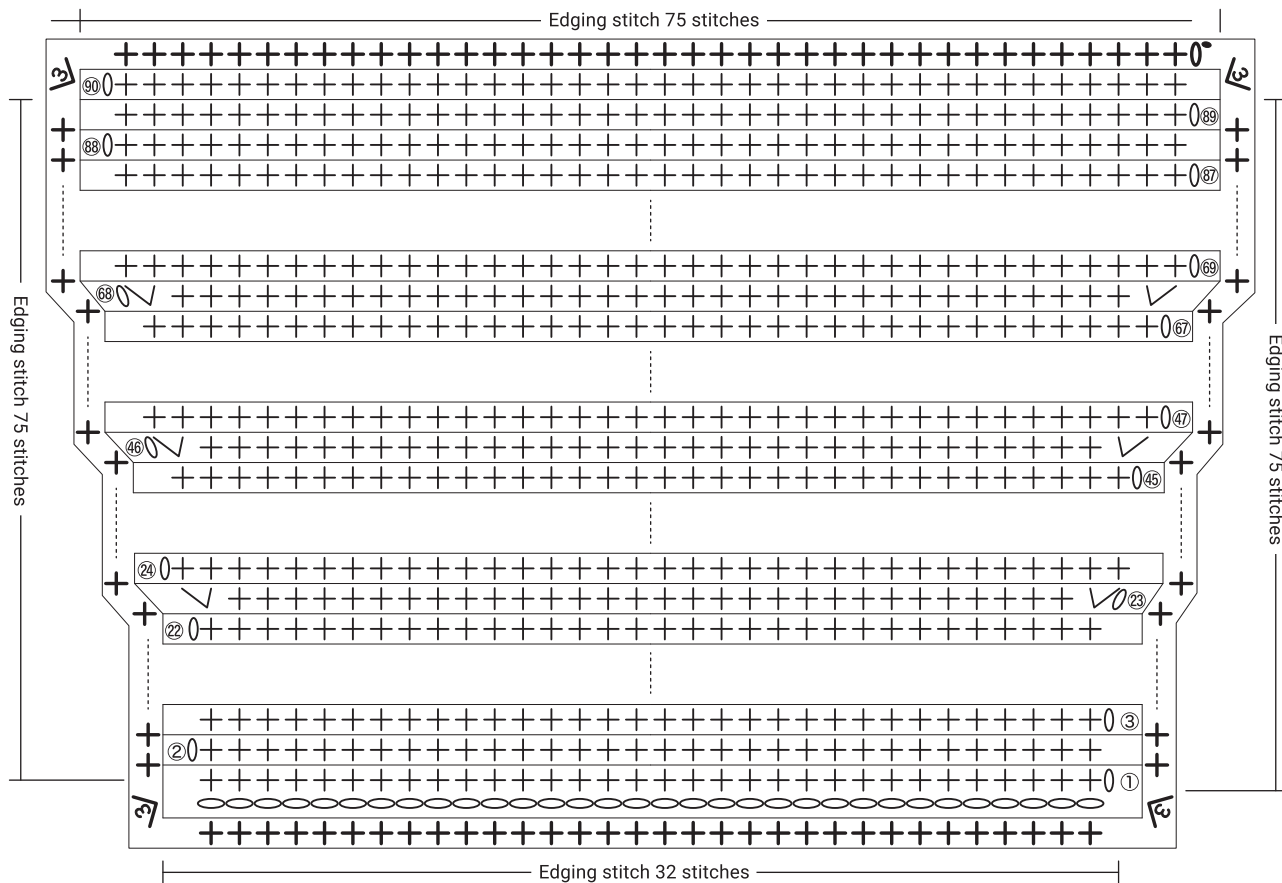

Top cowl cover finish

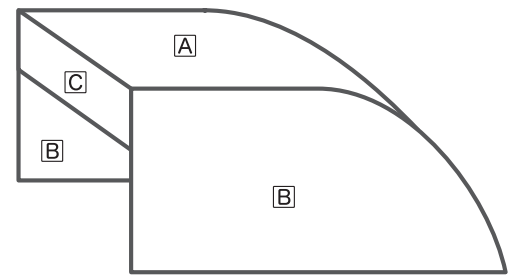

Crochet together with silver quadruple strand back sc

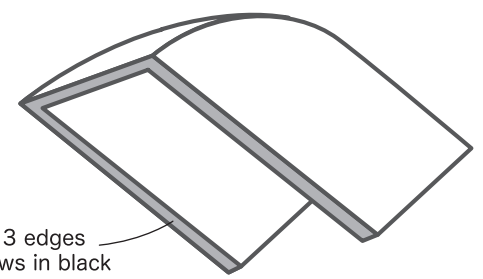
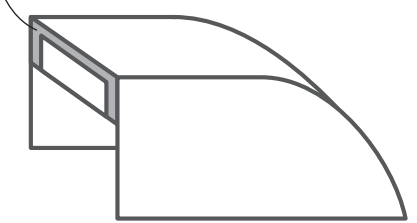

Pick up the 3 edges and sc 2 rows in black

Top cowl C

White (double strand 7/0) : 1

| Rows | Stitches |
|------|----------|
| 5 | 38 |
| ⋮ | ⋮ |
| 1 | 38 |

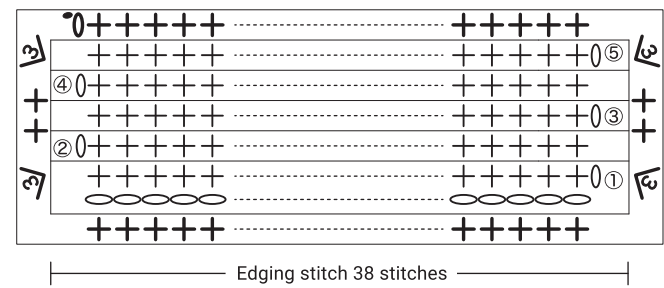

*Starter ch 38 stitches



| Rows | Stitches |
|------|------------|
| 35 | 32(-9) |
| 34 | 41(-1) |
| 33 | 42(-5) |
| 32 | 47(-2) |
| 31 | 49(+1, -2) |
| 30 | 50(-1) |
| 29 | 51(-1) |
| 28 | 52(-1) |
| 27 | 53 |
| 26 | 53(-1) |
| 25 | 54 |
| 24 | 54 |
| 23 | 54(+1, -1) |
| 22 | 54 |
| 21 | 54(-1) |
| 20 | 55 |
| 19 | 55 |
| 18 | 55(-1) |
| 17 | 56 |
| 16 | 56 |
| 15 | 56(+1, -1) |
| 14 | 56 |
| 13 | 56 |
| 12 | 56(-1) |
| 11 | 57 |
| 10 | 57 |
| 9 | 57(-1) |
| 8 | 58 |
| 7 | 58 |
| 6 | 58(+1, -1) |
| 5 | 58 |
| 4 | 58(+1) |
| 3 | 57(-1) |
| 2 | 58(+1) |
| 1 | 57(+1) |

*Starter ch 56 stitches

Top cowl  left, right **Yellow (double strand 7/0) : one of each**

-  ...attach the yarn
-  ...cut the yarn

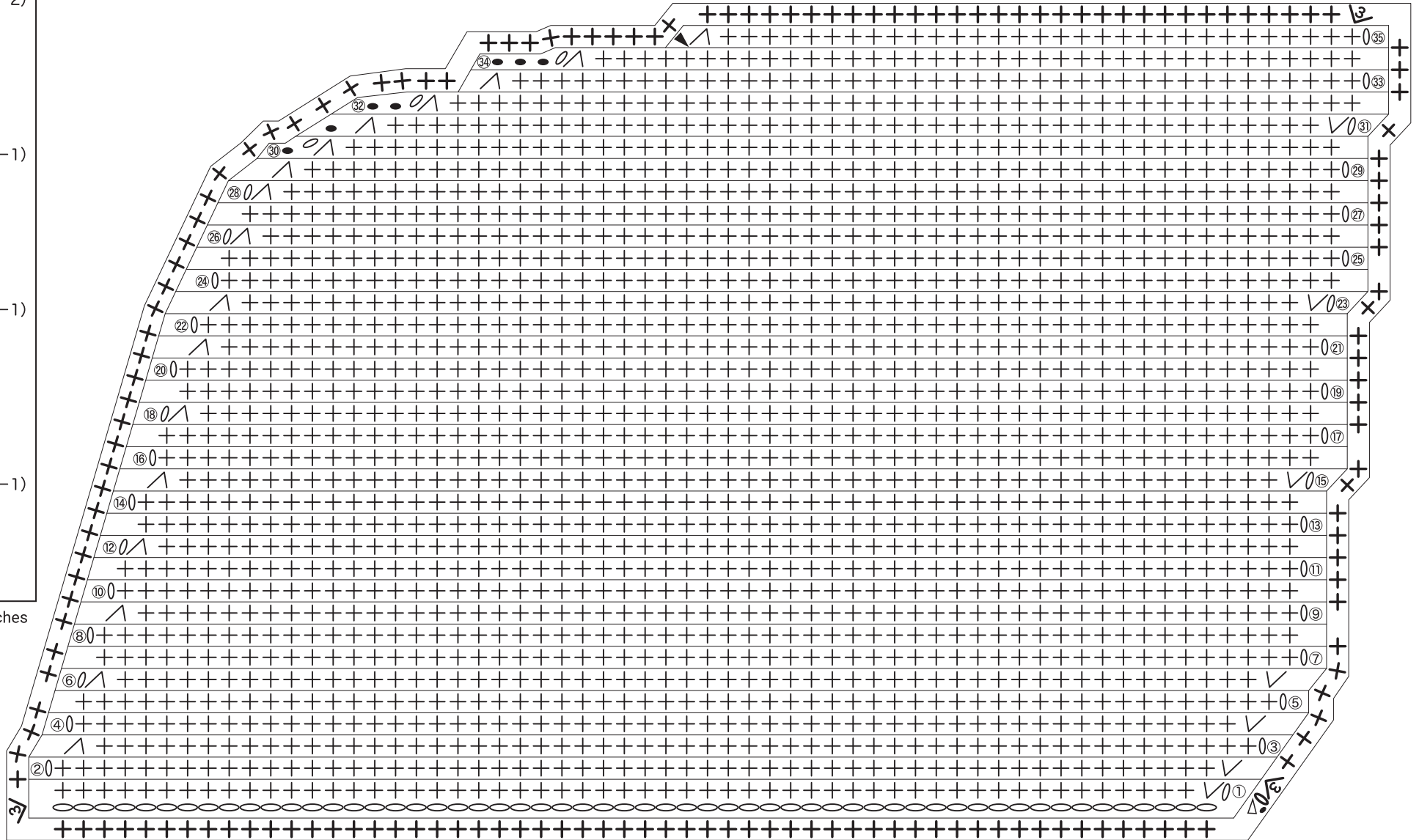

*Crochet edging stitch for the other piece in the opposite direction

Top cowl pedestal **A**

White (double strand 7/0) : 1

| Rows | Stitches |
|------|----------|
| 85 | 40 |
| ⋮ | ⋮ |
| 71 | 40 |
| 70 | 40(+2) |
| 69 | 38 |
| ⋮ | ⋮ |
| 43 | 38 |
| 42 | 38(+2) |
| 41 | 36 |
| ⋮ | ⋮ |
| 16 | 36 |
| 15 | 36(+2) |
| 14 | 34 |
| ⋮ | ⋮ |
| 1 | 34 |

*Starter ch 34 stitches

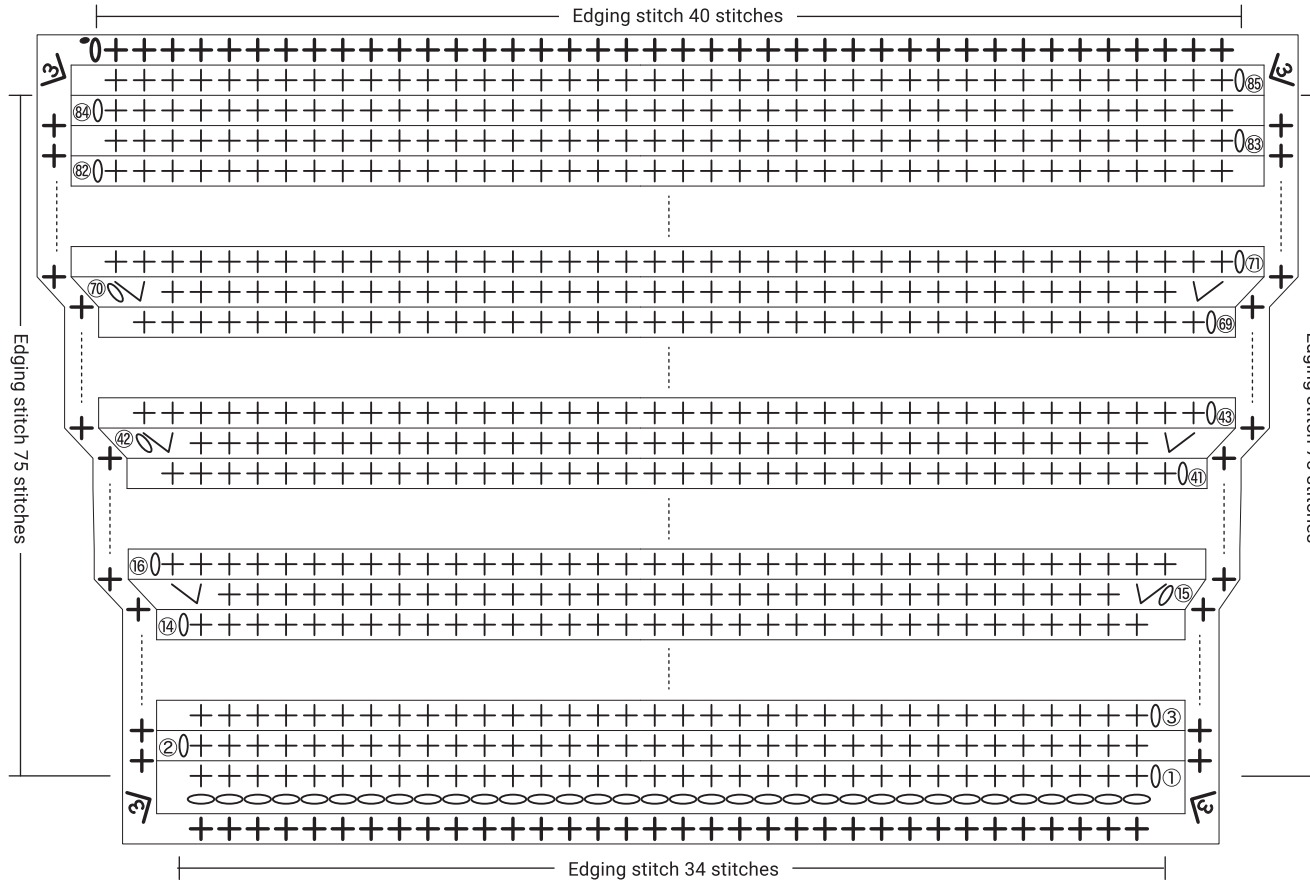

Top cowl pedestal ☐

White (double strand 7/0) :2

| Rows | Stitches |
|------|----------|
| 139 | 40 |
| ⋮ | ⋮ |
| 131 | 40 |
| 130 | 40 *bpsc |
| 129 | 40 |
| ⋮ | ⋮ |
| 79 | 40 |
| 78 | 40(+2) |
| 77 | 38 |
| ⋮ | ⋮ |
| 50 | 38 |
| 49 | 38(+2) |
| 48 | 36 |
| ⋮ | ⋮ |
| 22 | 36 |
| 21 | 36(+2) |
| 20 | 34 |
| ⋮ | ⋮ |
| 7 | 34 |
| 6 | 34 *bpsc |
| 5 | 34 |
| ⋮ | ⋮ |
| 1 | 34 |

*Starter ch 34 stitches

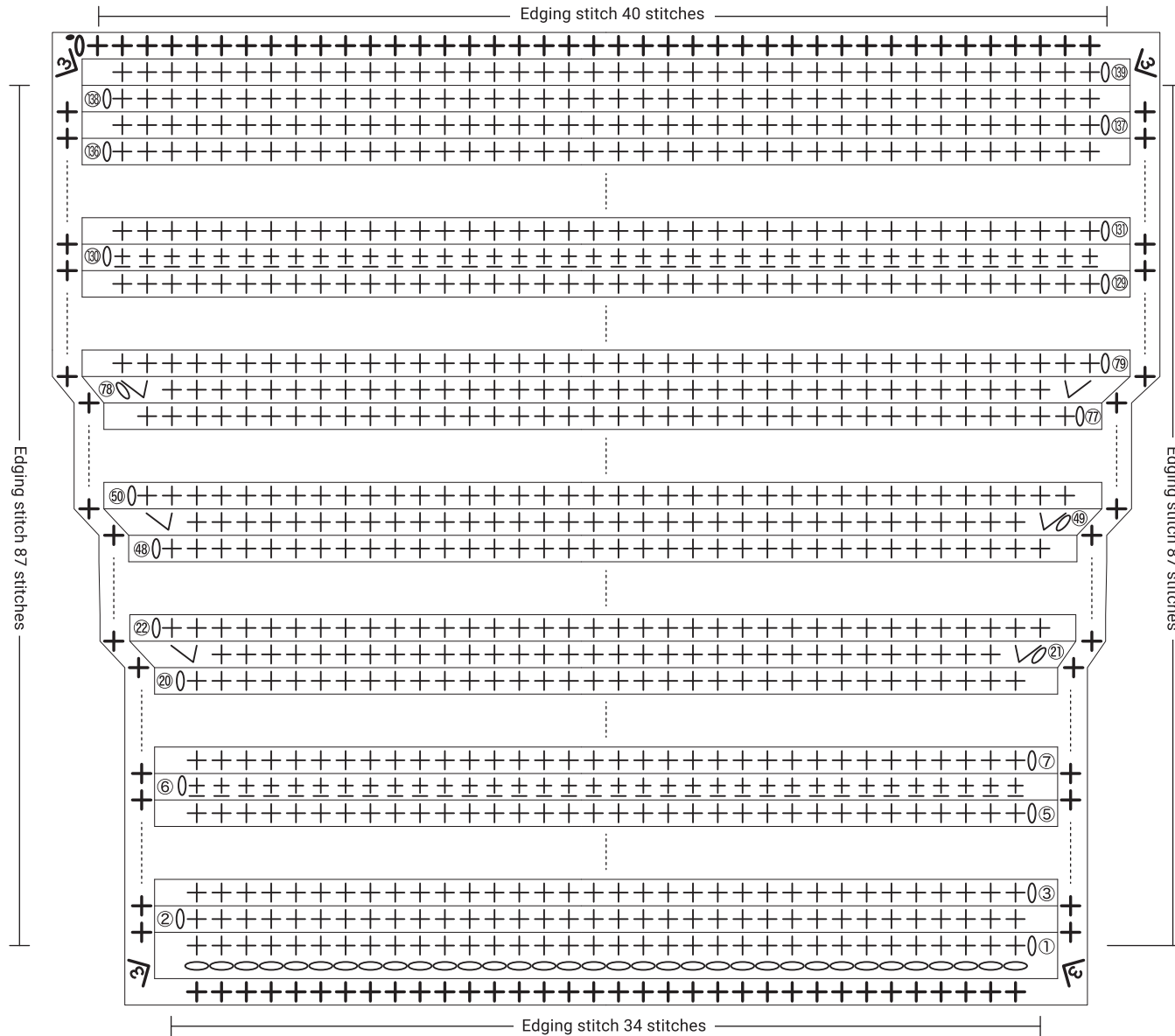

Top cowl bottom

Light grey (double strand 7/0) : 1

| Rows | Stitches |
|------|----------|
| 11 | 212(+2) |
| 10 | 210(+4) |
| 9 | 206(+2) |
| 8 | 204(+2) |
| 7 | 202(+2) |
| 6 | 200(+4) |
| 5 | 196(+2) |
| 4 | 194(+2) |
| 3 | 192(+6) |
| 2 | 186 |
| 1 | 186 |
| 65 | 35 |
| ⋮ | ⋮ |
| 1 | 35 |

Edging stitch

*Starter ch 35 stitches

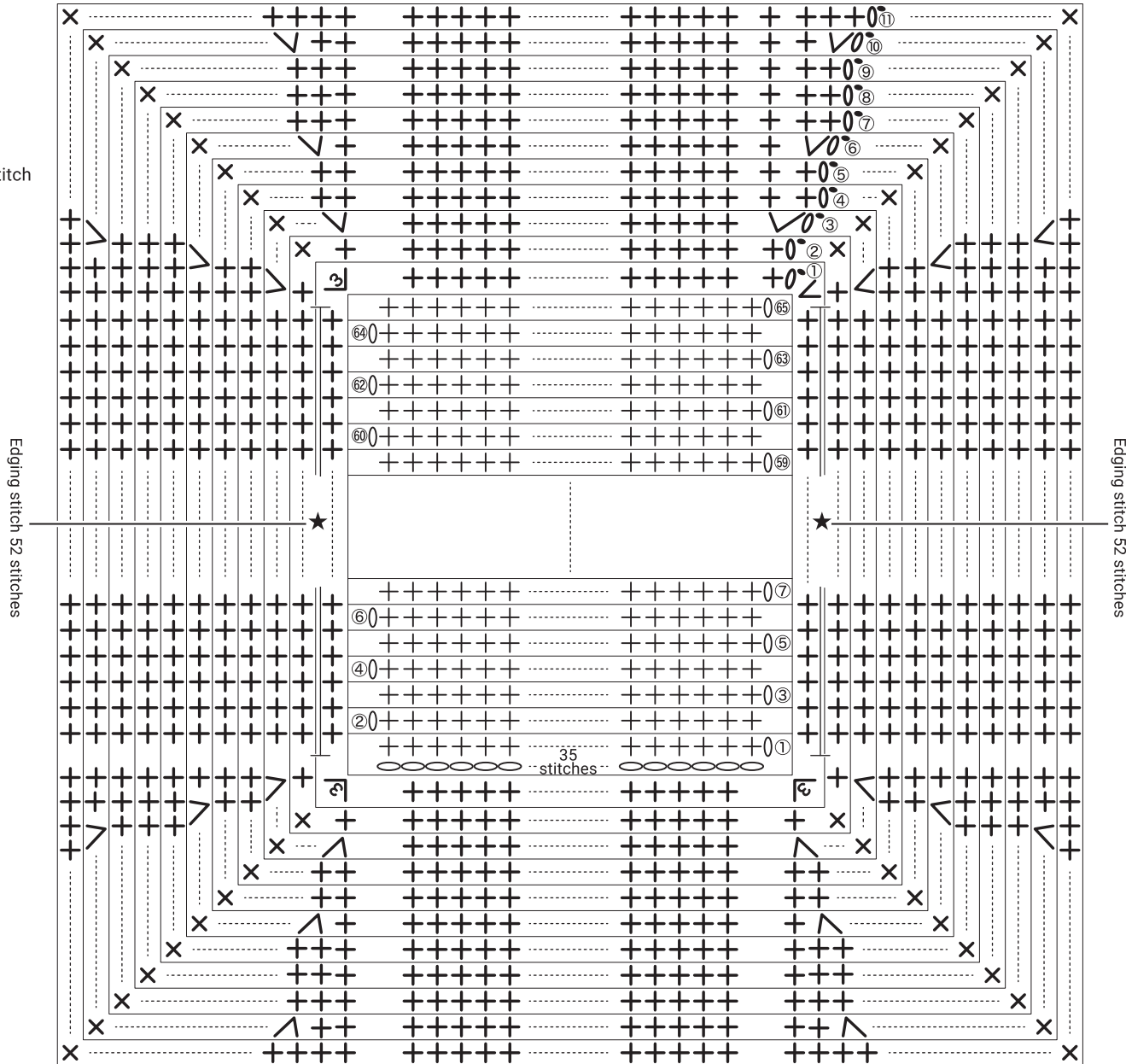

Operation panel

Cream (double strand 7/0) :1

| Rows | Stitches |
|------|----------|
| 35 | 37 |
| ⋮ | ⋮ |
| 32 | 37 |
| 31 | 37(-2) |
| 30 | 39 |
| ⋮ | ⋮ |
| 1 | 39 |

*Starter ch 39 stitches

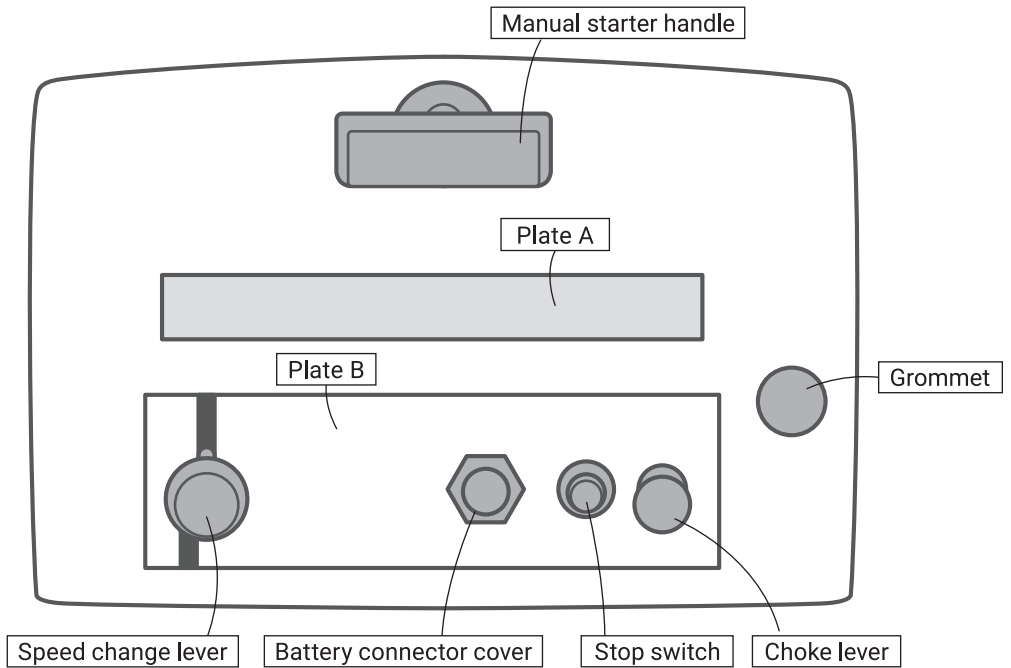
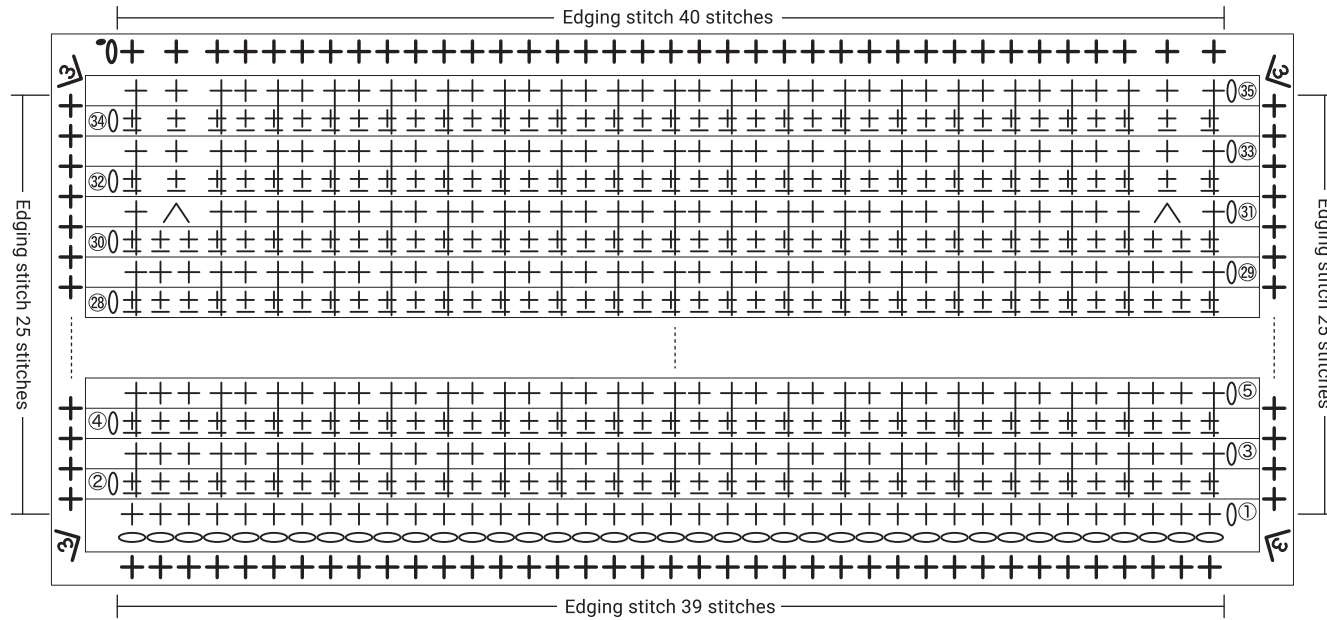

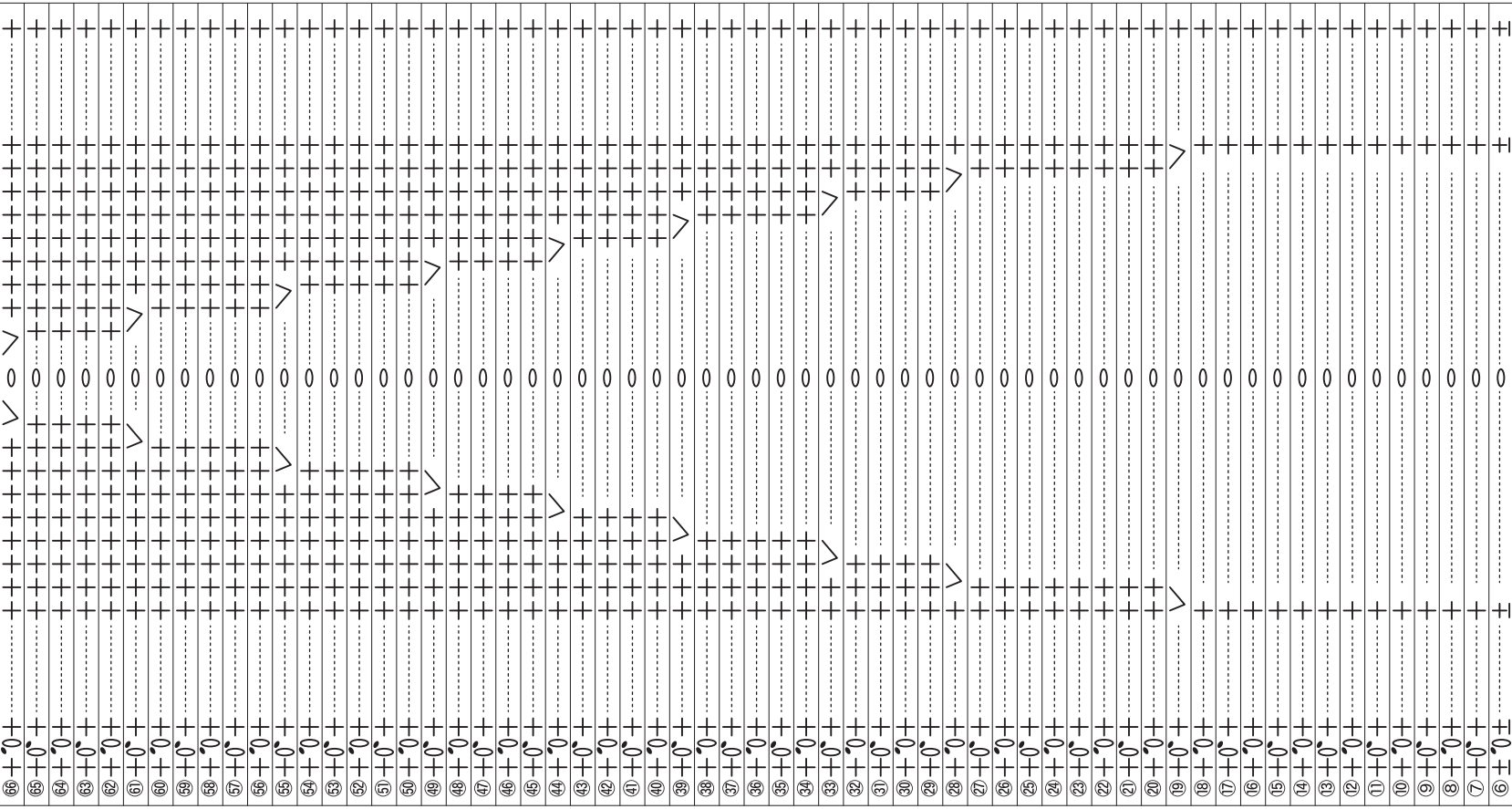

Casing upper ①

Light grey (double strand 7/0) : 1

| Rows | Stitches |
|------|----------|
| 66 | 82(+2) |
| 65 | 80 |
| ... | ... |
| 62 | 80 |
| 61 | 80(+2) |
| 60 | 78 |
| ... | ... |
| 56 | 78 |
| 55 | 78(+2) |
| 54 | 76 |
| ... | ... |
| 50 | 76 |
| 49 | 76(+2) |
| 48 | 74 |
| ... | ... |
| 45 | 74 |
| 44 | 74(+2) |
| 43 | 72 |
| ... | ... |
| 40 | 72 |
| 39 | 72(+2) |
| 38 | 70 |
| ... | ... |
| 34 | 70 |
| 33 | 70(+2) |
| 32 | 68 |
| ... | ... |
| 29 | 68 |
| 28 | 68(+2) |
| 27 | 66 |
| ... | ... |
| 20 | 66 |
| 19 | 66(+2) |
| 18 | 64 |
| ... | ... |
| 7 | 64 *bpsc |
| 6 | 64(+5) |
| 5 | 59(+6) |
| 4 | 53(+6) |
| 3 | 47(+11) |
| 2 | 36(+8) |
| 1 | 28 |

Double
crochet

*Starter ch 13 stitches

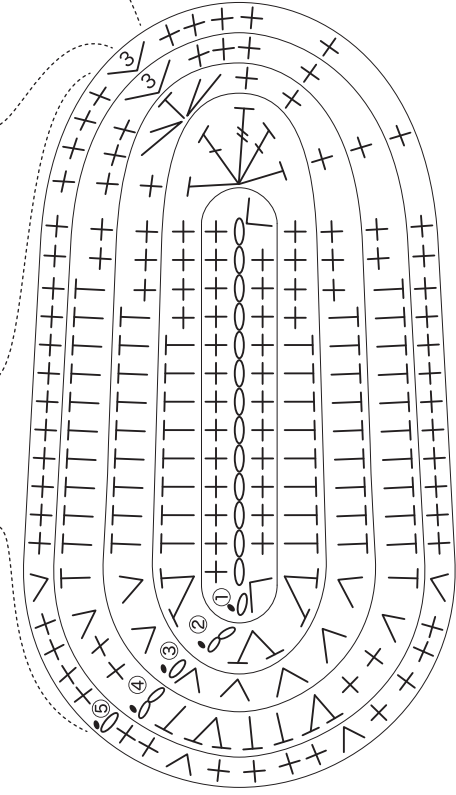

Casing upper ②

Light grey (double strand 7/0) :1

| Rows | Stitches |
|------|----------|
| 28 | 48 |
| ⋮ | ⋮ |
| 5 | 48 |
| 4 | 48 *bpsc |
| 3 | 48(+5) |
| 2 | 43(+7) |
| 1 | 36 |

Double
crochet

*Starter ch 17 stitches

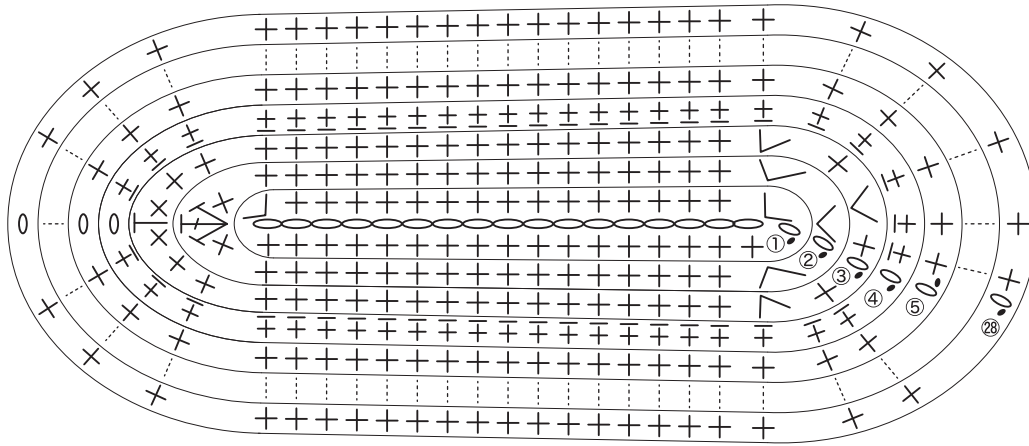

Exhaust vent

Light grey (double strand 7/0) :1

| Rows | Stitches |
|------|----------|
| 21 | 2(-2) |
| 20 | 4(-2) |
| 19 | 6 |
| 18 | 6(-2) |
| 17 | 8 |
| 16 | 8(-2) |
| 15 | 10 |
| 14 | 10(-2) |
| 13 | 12 |
| 12 | 12(-2) |
| 11 | 14 |
| 10 | 14(+2) |
| 9 | 12 |
| 8 | 12(+2) |
| 7 | 10 |
| 6 | 10(+2) |
| 5 | 8 |
| 4 | 8(+2) |
| 3 | 6 |
| 2 | 6(+2) |
| 1 | 4 |

*Starter ch 4 stitches

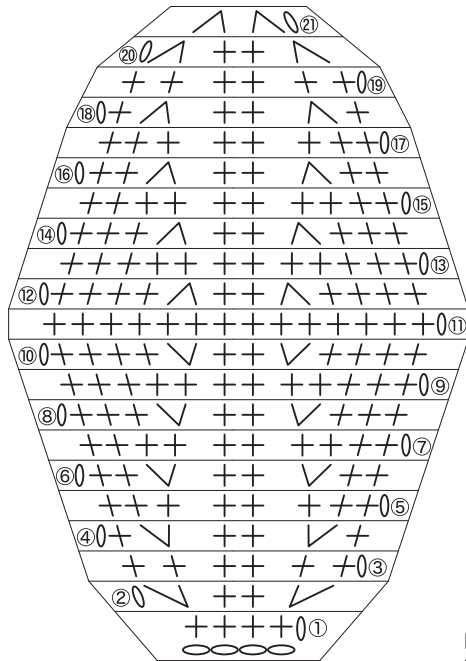

Fold and crochet together
3 sides with sc

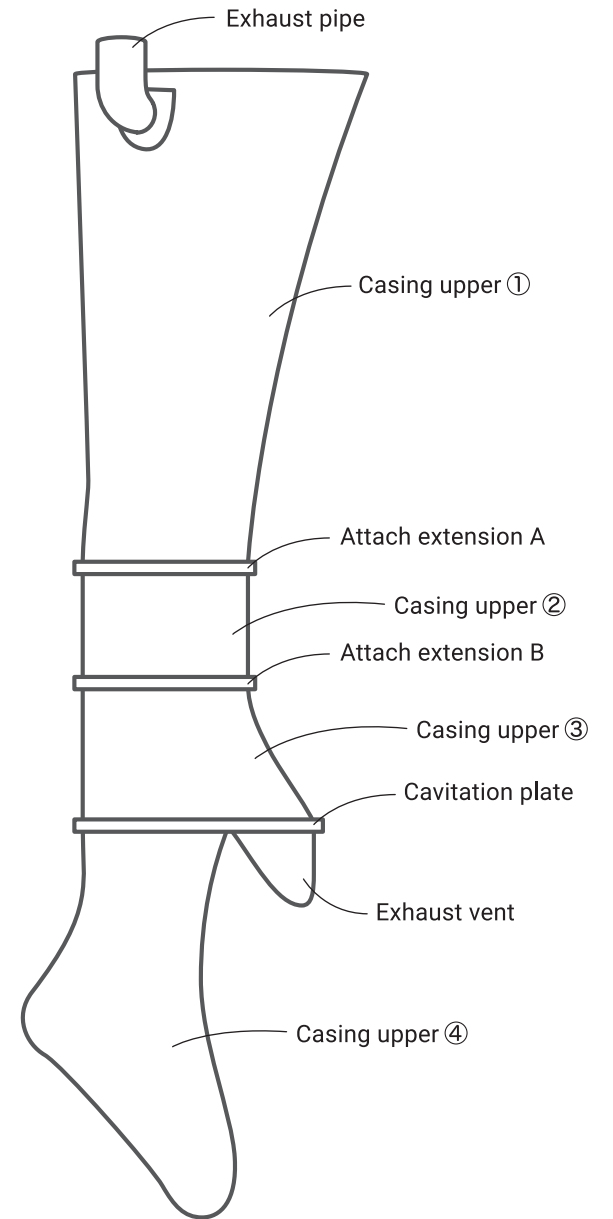

Casing upper ③

Light grey (double strand 7/0) : 1

| Rows | Stitches |
|------|----------|
| 20 | 64(+2) |
| 19 | 62(+2) |
| 18 | 60(+2) |
| 17 | 58 |
| 16 | 58(+2) |
| 15 | 56(+2) |
| 14 | 54 |
| 13 | 54(+2) |
| 12 | 52 |
| 11 | 52(+2) |
| 10 | 50 |
| 9 | 50 |
| 8 | 50(+2) |
| 7 | 48 |
| 6 | 48 |
| 5 | 48 |
| 4 | 48 *bpsc |
| 3 | 48(+5) |
| 2 | 43(+7) |
| 1 | 36 |

Double
crochet

*Starter ch 17 stitches

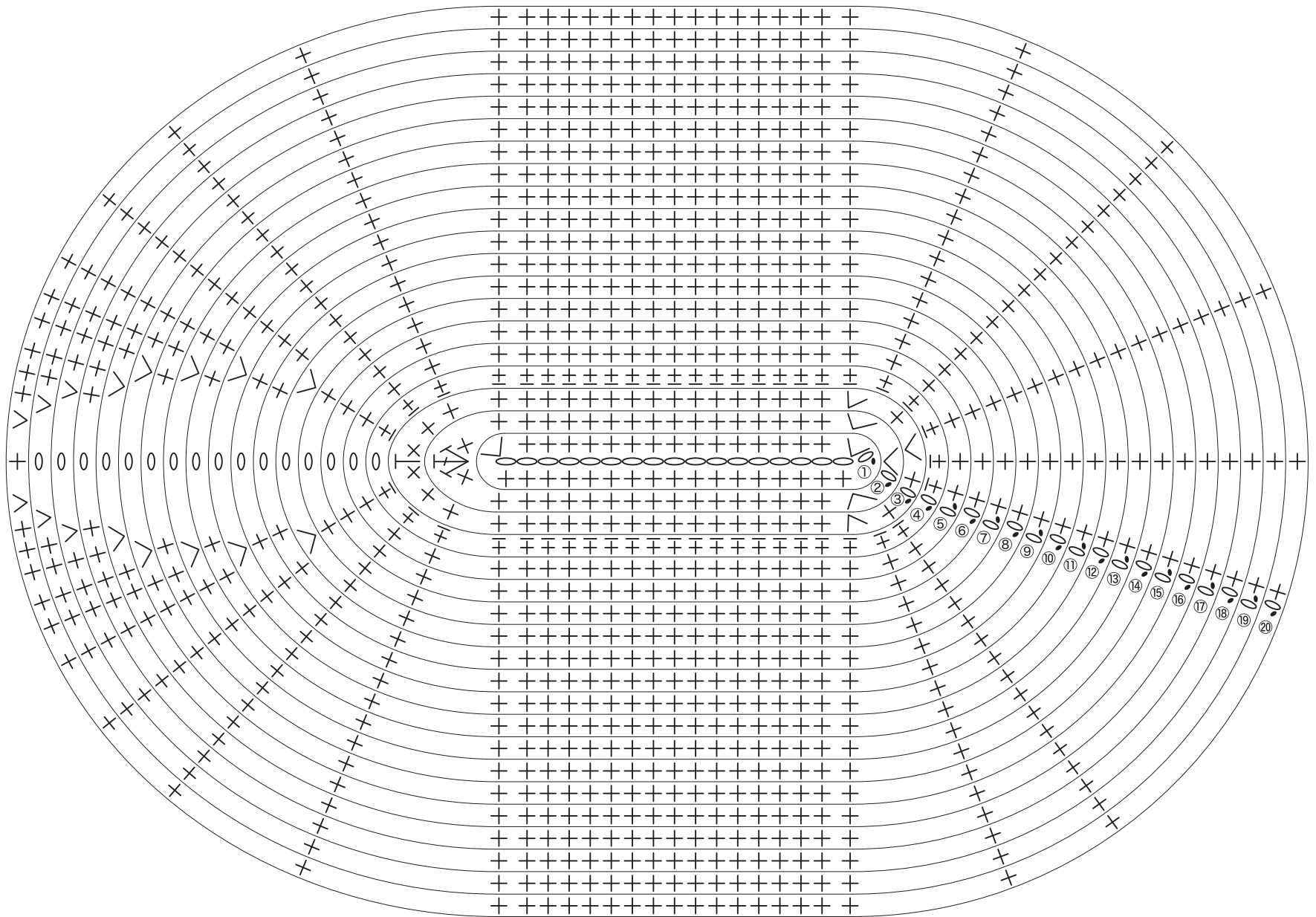

Casing upper ④

Light grey (double strand 7/0) : 1

| Rows | Stitches |
|------|----------|
| 51 | 40(+2) |
| 50 | 38 |
| 49 | 38(+2) |
| 48 | 36 |
| 47 | 36(+2) |
| 46 | 34 |
| 45 | 34(-2) |
| 44 | 36(+2) |
| 43 | 34 |
| 42 | 34 |
| 41 | 34(+2) |
| 40 | 32 |
| 39 | 32 |
| 38 | 32(-2) |
| 37 | 34 |
| 36 | 34 |
| 35 | 34 |
| 34 | 34(-2) |
| 33 | 36(-4) |
| 32 | 40(-2) |
| 31 | 42 |
| 30 | 42(-2) |
| 29 | 44(-2) |
| 28 | 46(-2) |
| 27 | 48(+2) |
| 26 | 46(+2) |
| 25 | 44(+2) |
| 24 | 42(+2) |
| 23 | 40(+4) |
| 22 | 36(+2) |
| 21 | 34(+4) |
| 20 | 30 |
| 19 | 30(+4) |
| 18 | 26 |
| 17 | 26(+2) |
| 16 | 24(+2) |
| 15 | 22(+2) |
| 14 | 22(+2) |
| 13 | 20(+2) |
| 12 | 18 |
| 11 | 18 |
| 10 | 18(+2) |
| 9 | 16 |
| 8 | 16(+2) |
| 7 | 14 |
| 6 | 14 |
| 5 | 14(+2) |
| 4 | 12 |
| 3 | 12(+2) |
| 2 | 10(+2) |
| 1 | 8 |

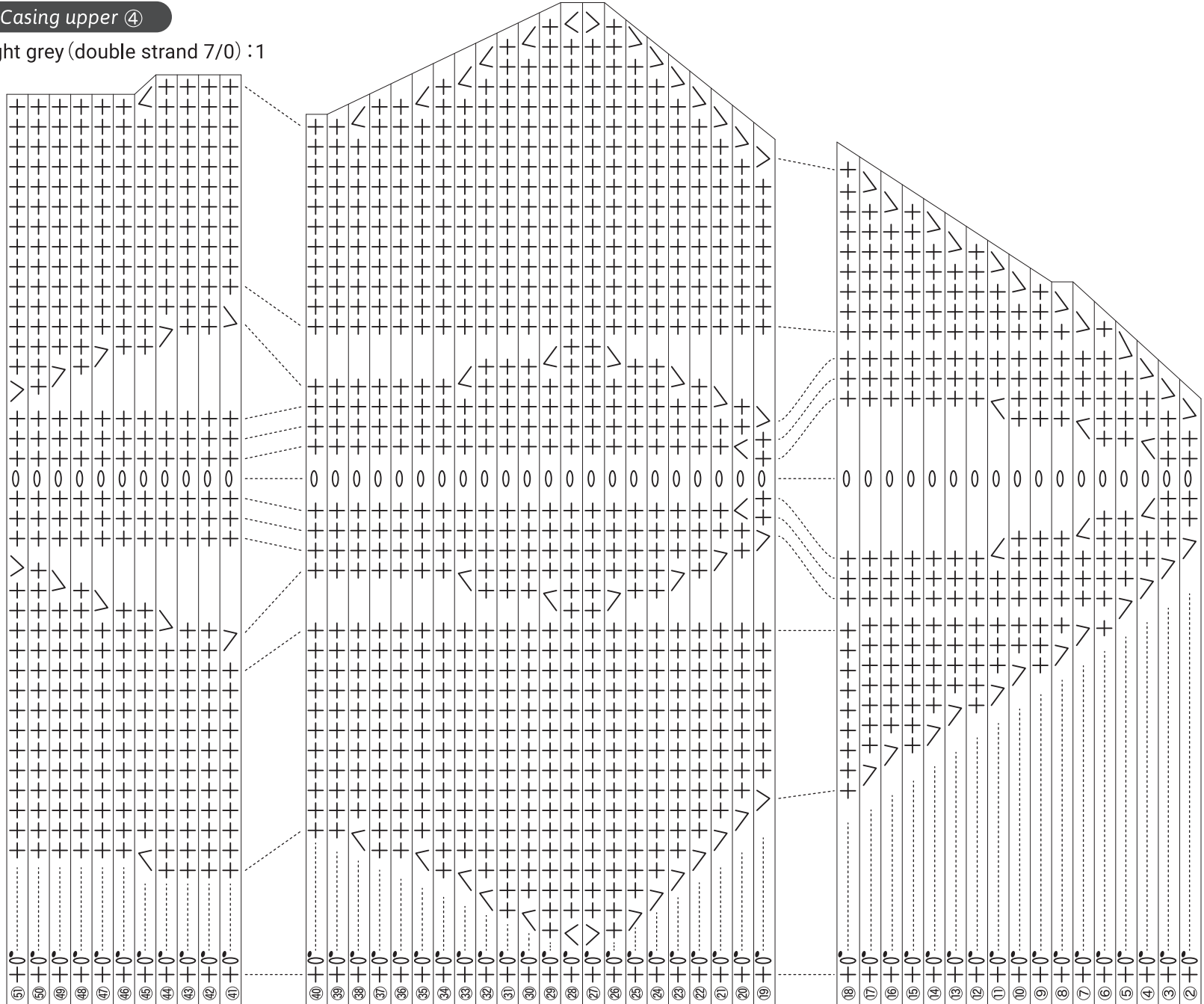

*Starter ch 3 stitches

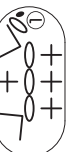

Attach extensions **A** - **B**

Light grey (double strand 7/0) : 4

| Rows | Stitches |
|------|----------|
| 6 | 64(+5) |
| 5 | 59(+6) |
| 4 | 53(+6) |
| 3 | 47(+11) |
| 2 | 36(+8) |
| 1 | 28 |

*Starter ch 13 stitches

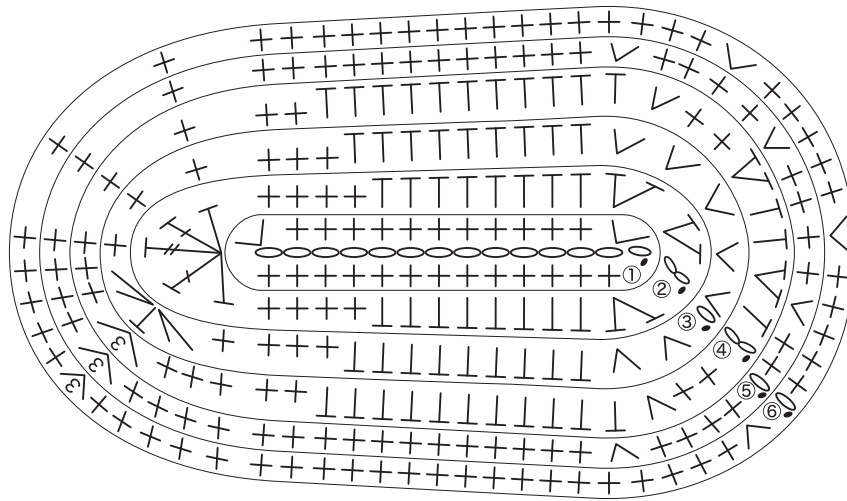

Exhaust pipe

Light grey (double strand 7/0) : 1

| Rows | Stitches |
|------|----------|
| 20 | 4(-2) |
| 19 | 6(-3) |
| 18 | 9 |
| 17 | 9(-3) |
| 16 | 12 |
| 15 | 12(-3) |
| 14 | 15 |
| : | : |
| 8 | 15 |
| 7 | 15(+3) |
| 6 | 12 |
| 5 | 12(+3) |
| 4 | 9 |
| 3 | 9(+3) |
| 2 | 6(+2) |
| 1 | 4 |

*Starter ch 4 stitches

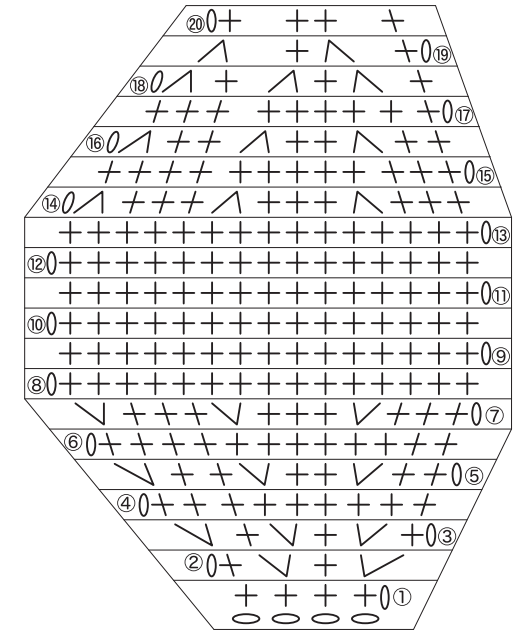

Exhaust bottom

Light grey (double strand 7/0) : 1

| Rows | Stitches |
|------|----------|
| 13 | 37 |
| : | : |
| 10 | 37 *bpsc |
| 9 | 37 |
| 8 | 10(+2) |
| 7 | 8 |
| 6 | 8 |
| 5 | 8 |
| 4 | 8(+2) |
| 3 | 6(+2) |
| 2 | 4(+2) |
| 1 | 2 |

Edging stitch

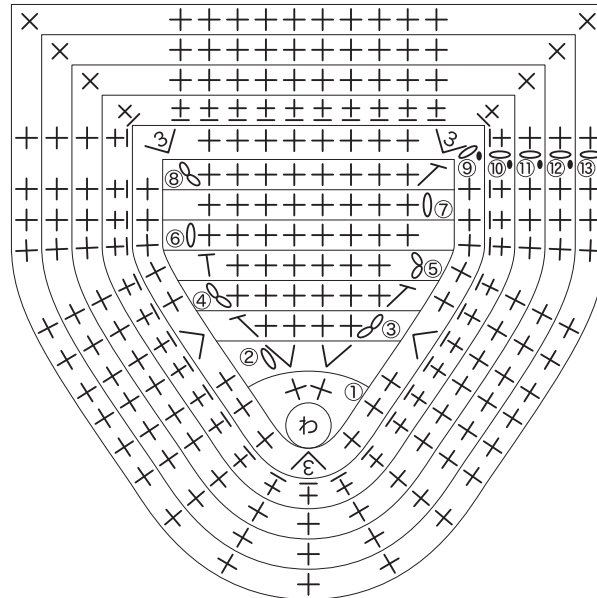

Edging stitch 20 stitches 2 rows

Graft

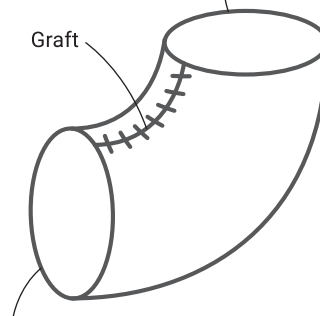

Edging stitch 20 stitches 1 row

Cavitation plate

Light grey (double strand 7/0) : 2

| Rows | Stitches |
|------|----------|
| 38 | 94(+10) |
| 37 | 84(+6) |
| 36 | 78 |
| 35 | 4(-2) |
| 34 | 6(-2) |
| 33 | 8 |
| 32 | 8 |
| 31 | 8(-2) |
| 30 | 10 |
| 29 | 10 |
| 28 | 10(-2) |
| 27 | 12 |
| ⋮ | ⋮ |
| 24 | 12(-2) |
| 23 | 14 |
| 22 | 14 |
| 21 | 14(-2) |
| 20 | 16 |
| ⋮ | ⋮ |
| 15 | 16(-2) |
| 14 | 18 |
| ⋮ | ⋮ |
| 4 | 18(+2) |
| 3 | 16(+2) |
| 2 | 14(+2) |
| 1 | 12 |

Edging stitch

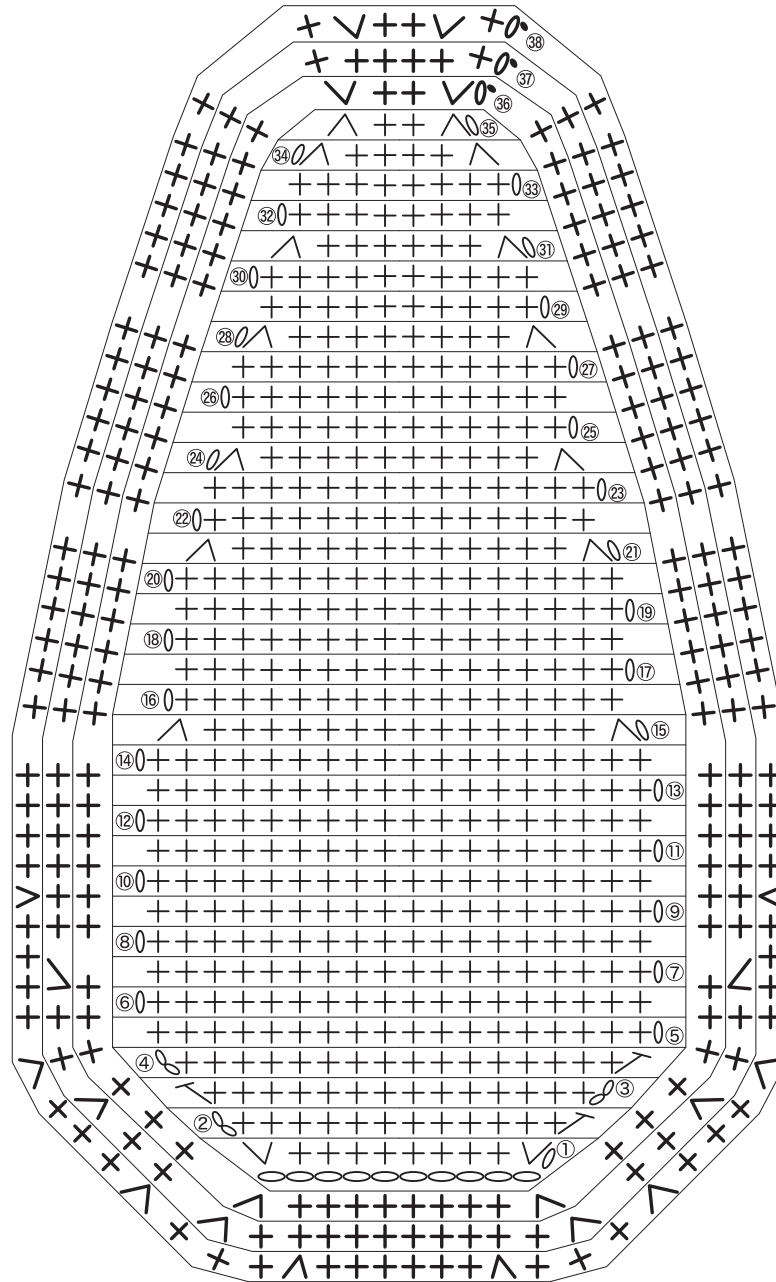

*Starter ch 10 stitches

Grip A

Light grey (double strand 7/0) :1

| Rows | Stitches |
|------|-----------|
| 9 | 103 |
| 8 | 103 |
| 7 | 103 |
| 6 | 103 *bpsc |
| 5 | 103 |
| 4 | 47(+14) |
| 3 | 33 |
| 2 | 33 |
| 1 | 33 |

*Starter ch 33 stitches

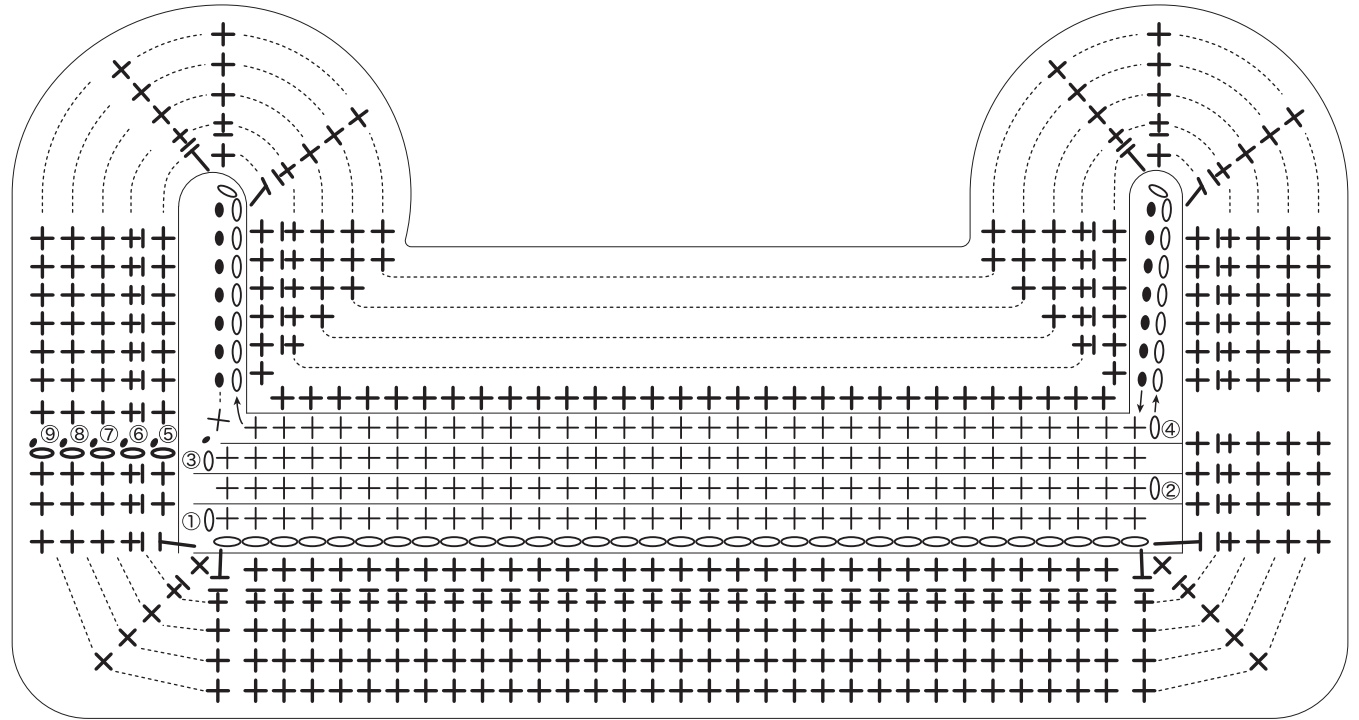
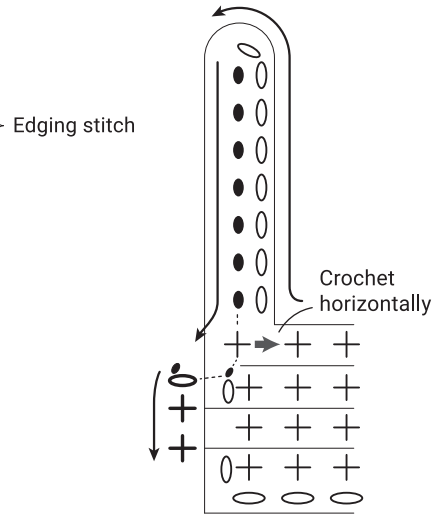

Grip B

Light grey (double strand 7/0) :1

| Rows | Stitches |
|------|----------|
| 5 | 103 |
| 4 | 47(+14) |
| 3 | 33 |
| 2 | 33 |
| 1 | 33 |

*Starter ch 33 stitches

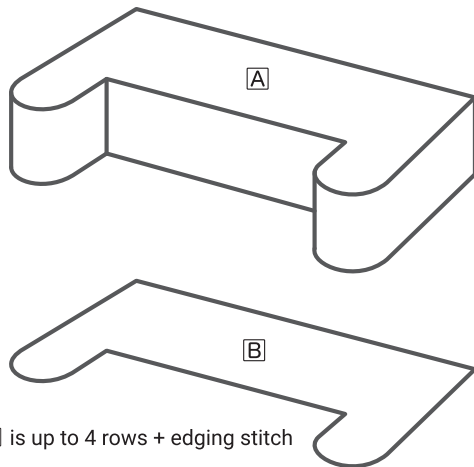

※ B is up to 4 rows + edging stitch

Handle join

Light grey (double strand 7/0) :1

Handle B

| Rows | Stitches |
|------|----------|
| 8 | 26 |
| 7 | 26 |
| 6 | 26 *bpsc |
| 5 | 26(+14) |
| 4 | 8 |
| 3 | 8(+3) |
| 2 | 5 |
| 1 | 5(+2) |

*Starter ch 3 stitches

Handle A

Up to the 5th row of A

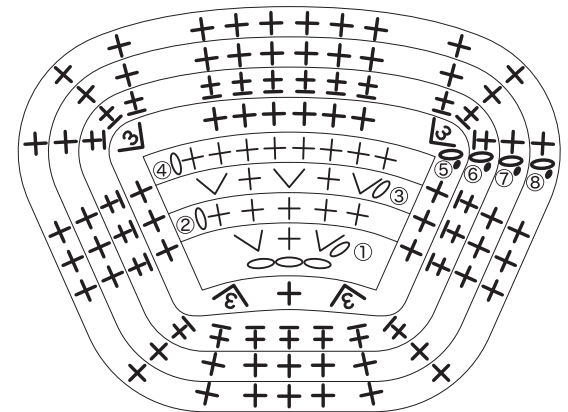

Speed change lever (1 strand 4/0) : 1

| Rows | Stitches | Colour |
|------|----------|------------|
| 8 | 5 | Light grey |
| 7 | 5(-5) | |
| 6 | 10(-10) | Black |
| 5 | 20 | |
| 4 | 20(+4) | |
| 3 | 16 *bpsc | |
| 2 | 16(+8) | |
| 1 | 8 | |

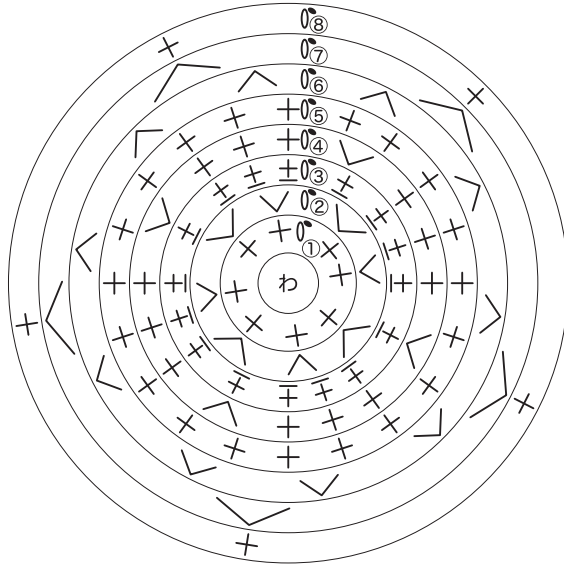

Choke lever

Black (1 strand 4/0) : 1

| Rows | Stitches |
|------|----------|
| 7 | 12(+4) |
| 6 | 8 |
| 5 | 8 |
| 4 | 8(-4) |
| 3 | 12 *bpsc |
| 2 | 12(+4) |
| 1 | 8 |

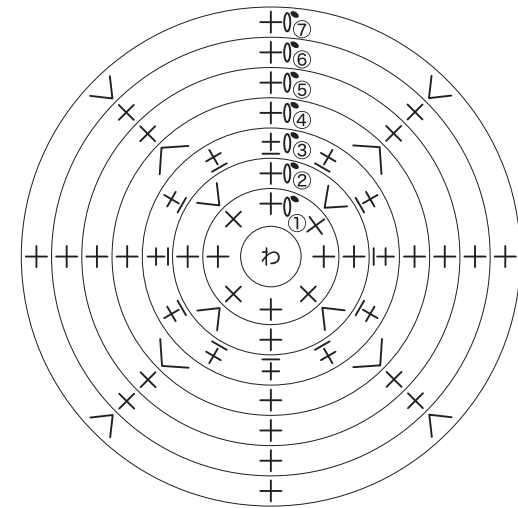

Battery connector

A Black (1 strand 4/0) : 1

| Rows | Stitches |
|------|----------|
| 2 | 12(+6) |
| 1 | 6 |

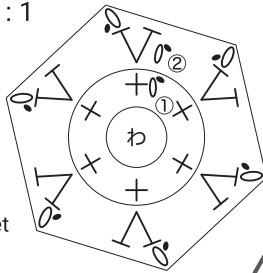

*ch 1 stitch of picot crochet

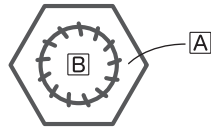

Stop switch

A Light Grey (1 strand 4/0) : 1

| Rows | Stitches |
|------|----------|
| 3 | 9 *bpsc |
| 2 | 9(+3) |
| 1 | 6 |

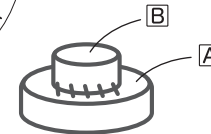
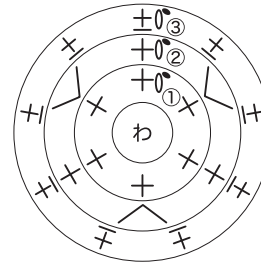

Grommet

Black (1 strand 4/0) : 1

| Rows | Stitches |
|------|----------|
| 2 | 14(+7) |
| 1 | 7 |

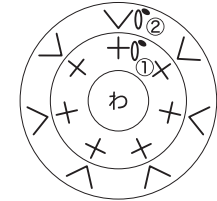

B Light Grey (1 strand 4/0) : 1

| Rows | Stitches |
|------|----------|
| 3 | 12 *bpsc |
| 2 | 12(+6) |
| 1 | 6 |

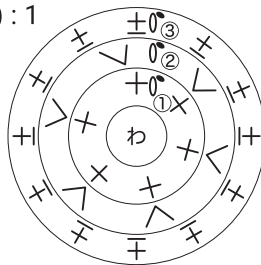

B Black (1 strand 4/0) : 1

| Rows | Stitches |
|------|----------|
| 2 | 6 *bpsc |
| 1 | 6 |

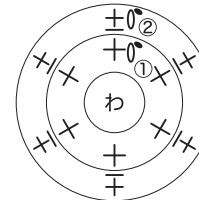

Manual starter handle

A (1 strand 4/0) : 1

| Rows | Stitches | Colour |
|------|--------------|------------|
| 6 | 44(+8) | Black |
| 5 | 36 | |
| 4 | 36 | |
| 3 | 36(+8) *bpsc | |
| 2 | 28(+18) | |
| 1 | 10 | Light grey |

*Starter ch 10 stitches

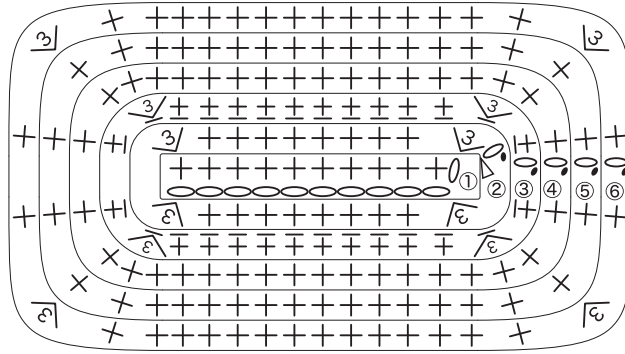

C Black (1 strand 4/0) : 1

| Rows | Stitches |
|------|----------|
| 8 | 16(+4) |
| 7 | 12 |
| ⋮ | ⋮ |
| 3 | 12 |
| 2 | 12(+6) |
| 1 | 6 |

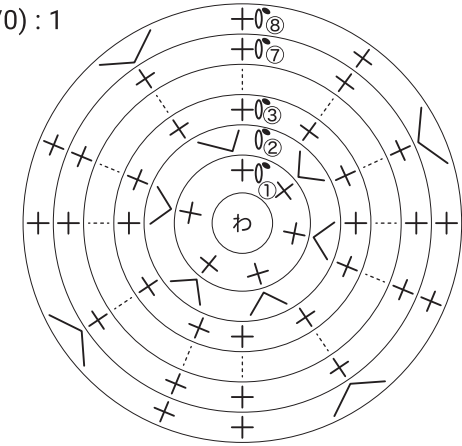

B Black (1 strand 4/0) : 1

| Rows | Stitches |
|------|----------|
| 4 | 44(+8) |
| 3 | 36(+8) |
| 2 | 28(+8) |
| 1 | 20 |

*Starter ch 16 stitches

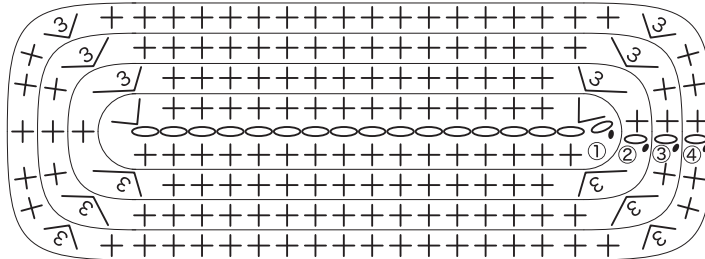

D Black (1 strand 4/0) : 1

| Rows | Stitches |
|------|----------|
| 3 | 24(+8) |
| 2 | 16(+8) |
| 1 | 8 |

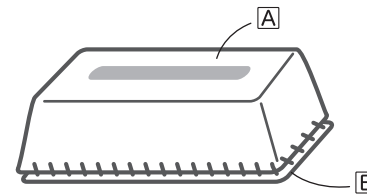
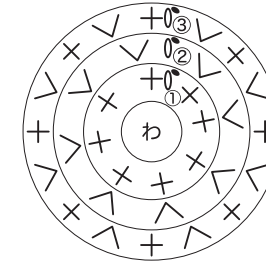

↑ Sew on

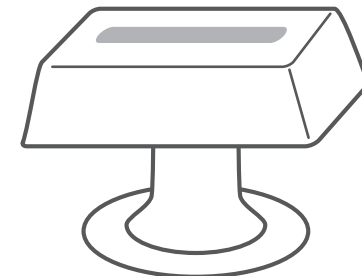
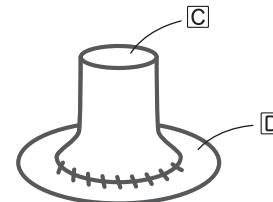

Top cowl side logo mark bottom

Black (1 strand 4/0) : 2

| Rows | Stitches |
|------|----------|
| 6 | 45 |
| ⋮ | ⋮ |
| 1 | 45 |

*Starter ch 45 stitches

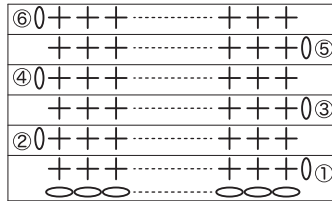

Embroidery diagram

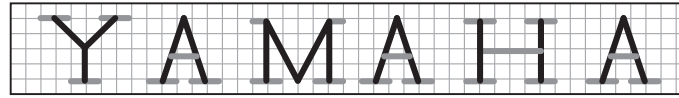

— Straight stitch (black/1 strand)
— ch (black/1 strand)

Logo mark

Yellow (1 strand 4/0) : 1

| Rows | Stitches |
|------|----------|
| 8 | 48(+6) |
| 7 | 42(+6) |
| 6 | 36(+6) |
| 5 | 30(+6) |
| 4 | 24(+6) |
| 3 | 18(+6) |
| 2 | 12(+6) |
| 1 | 6 |

*Starter ch 2 stitches

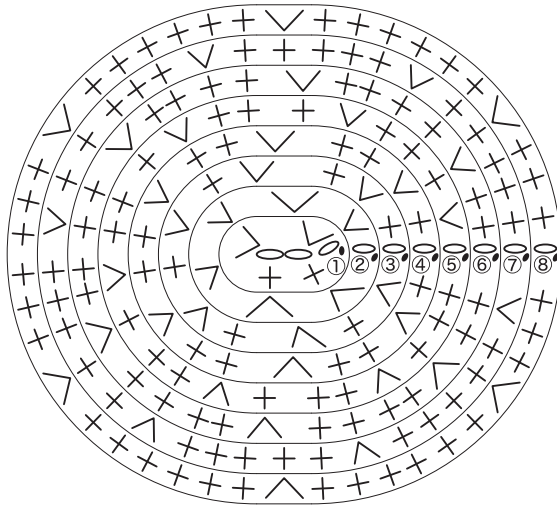

Plate A

Red (1 strand 4/0) : 1

| Rows | Stitches |
|------|----------|
| 4 | 40 |
| ⋮ | ⋮ |
| 1 | 40 |

*Starter ch 40 stitches

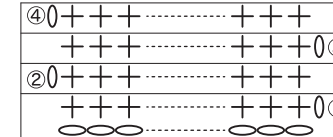
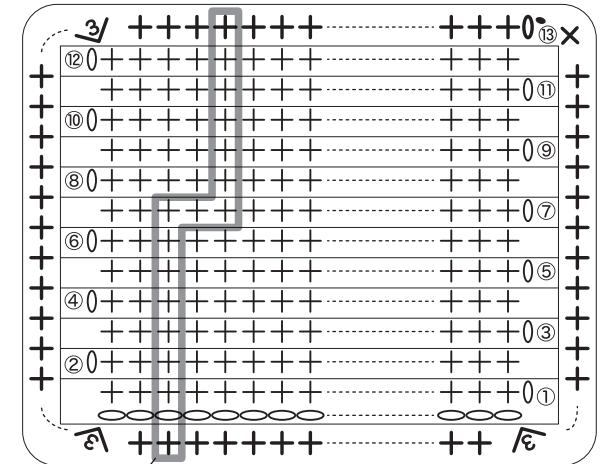

Plate B

Red (1 strand 4/0) : 1

| Rows | Stitches |
|------|-----------|
| 13 | 113 *bpsc |
| 12 | 42 |
| ⋮ | ⋮ |
| 1 | 42 |

*Starter ch 42 stitches



Last, ch with 1 black strand

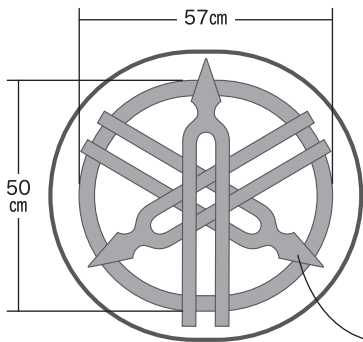

ch with 1 silver strand

Propellor axis

Grey (double strand 7/0) : one of each

| Rows | Stitches |
|------|----------------------------------|
| 13 | 30 |
| : | : |
| 6 | 30(+6) |
| 5 | 24 |
| 4 | 24 *Pick up the front with bpssc |
| 3 | 24(+8) |
| 2 | 16(+8) |
| 1 | 8 |

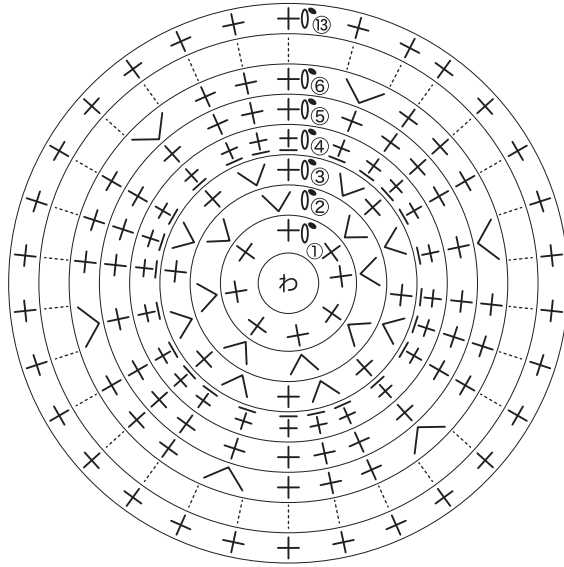

Propellor blades

Grey (double strand 7/0) : 3

| Rows | Stitches |
|------|-------------------|
| 18 | 39 ※Edging stitch |
| 17 | 5 |
| 16 | 5 |
| 15 | 5(-2) |
| 14 | 7 |
| 13 | 7 |
| 12 | 7(-1) |
| 11 | 8 |
| 10 | 8(-1) |
| 9 | 9 |
| 8 | 9(-1) |
| 7 | 10 |
| 6 | 10 |
| 5 | 10 |
| 4 | 10(+2) |
| 3 | 8(+2) |
| 2 | 6(+2) |
| 1 | 4 |

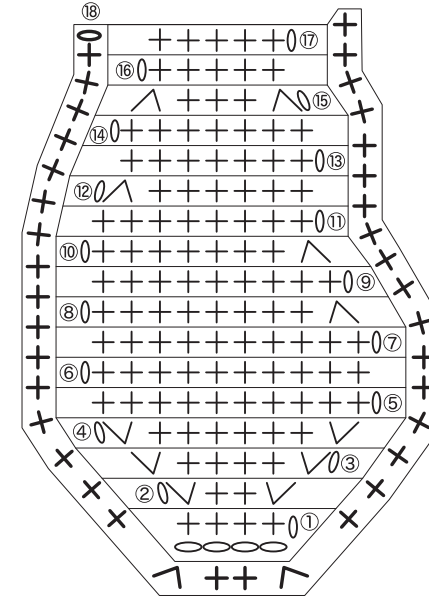

*Starter ch 4 stitches

Propellor nut

Light grey (triple strand 7/0) : 1

Gold (triple strand 7/0) : 2

| Rows | Stitches |
|------|----------|
| 3 | 8 |
| 2 | 8 |
| 1 | 8 |

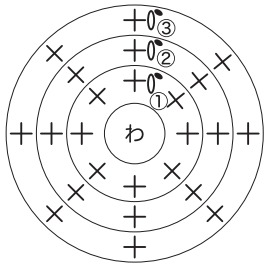

Propellor blade attachment angle

