

1

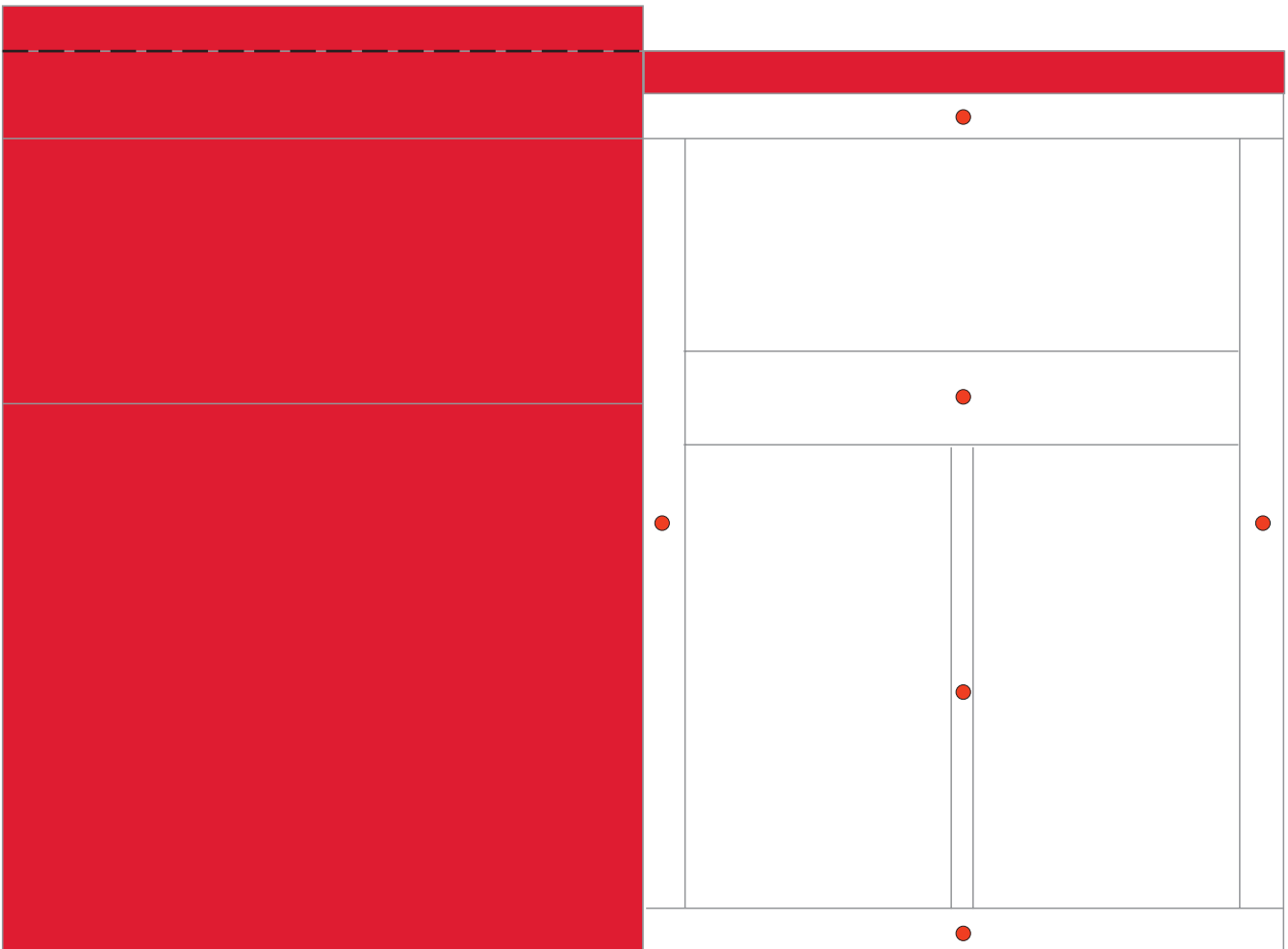

2

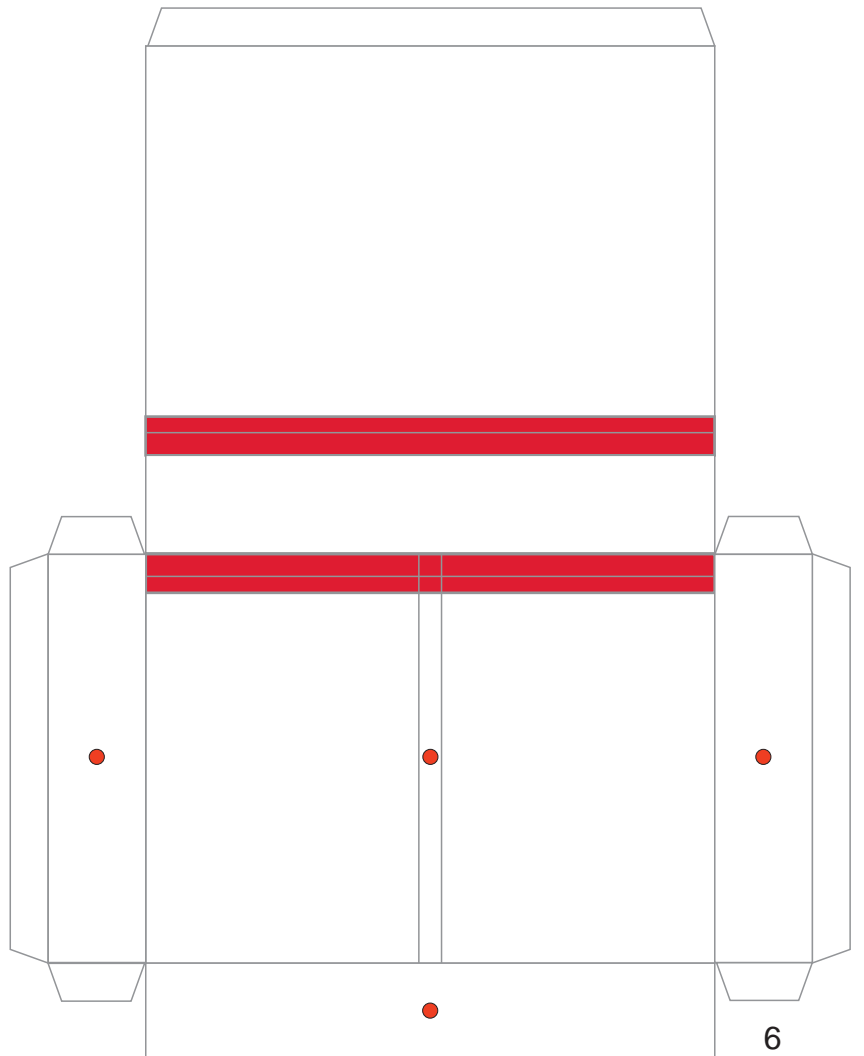

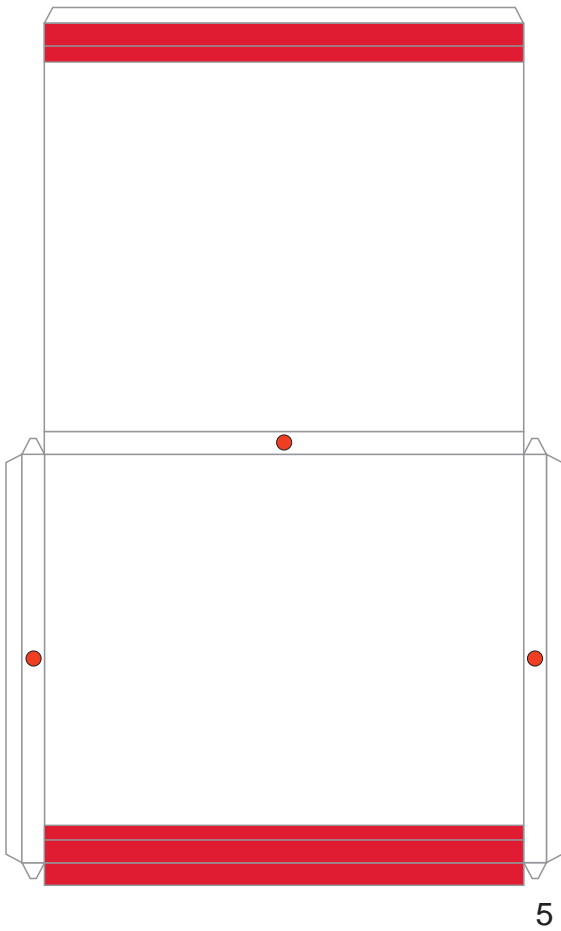
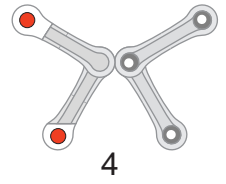
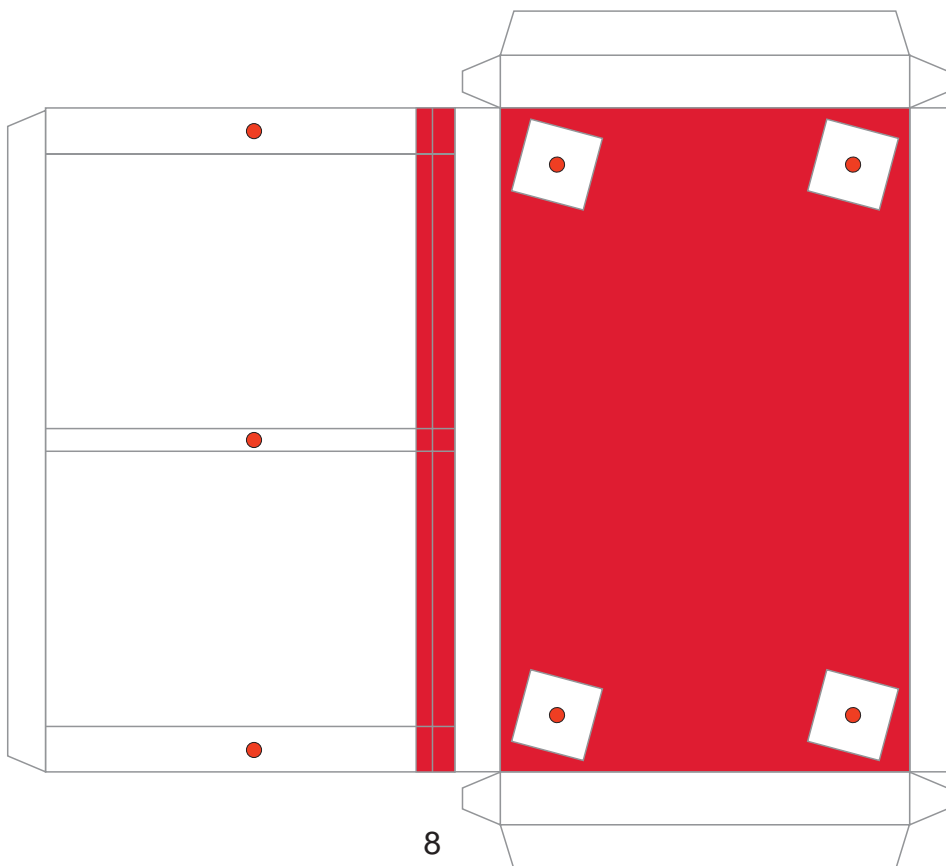
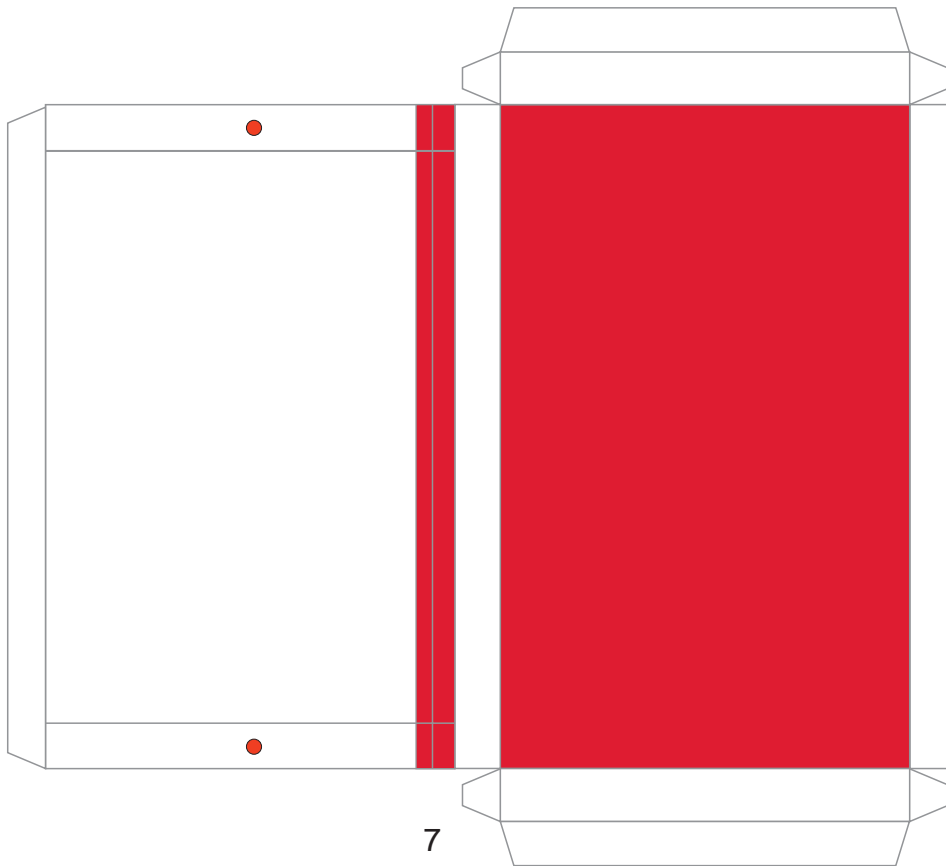

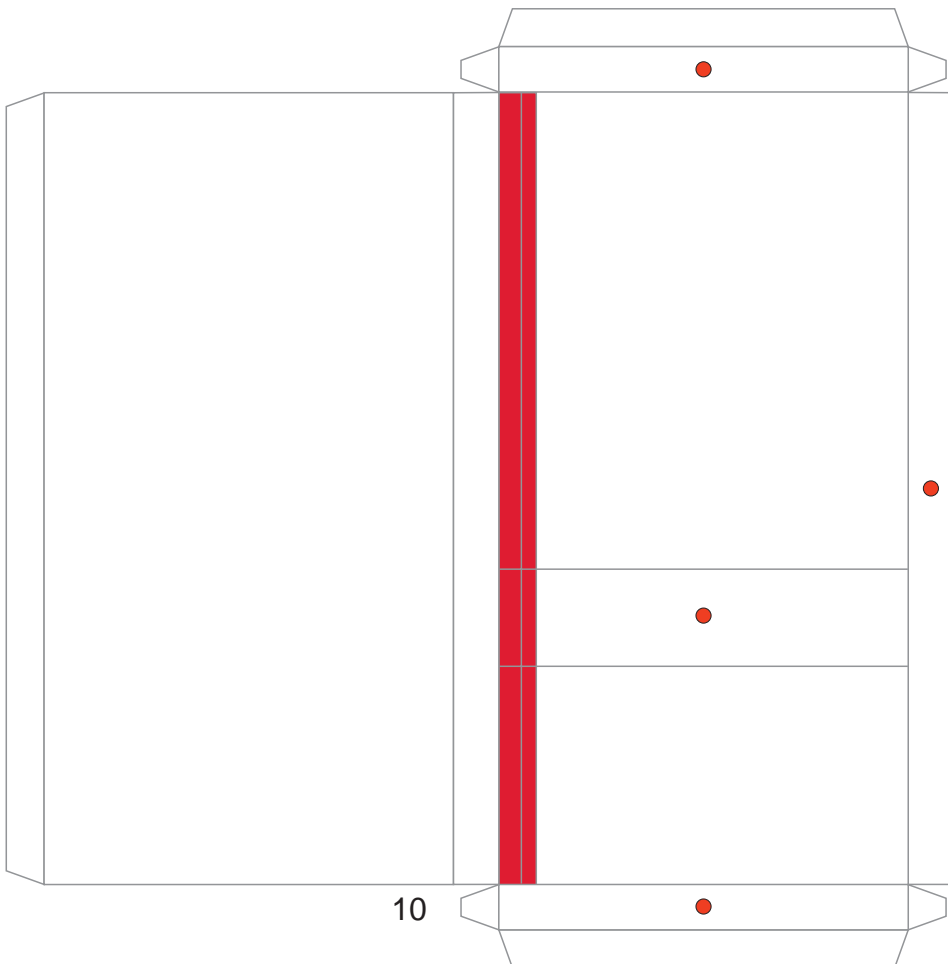
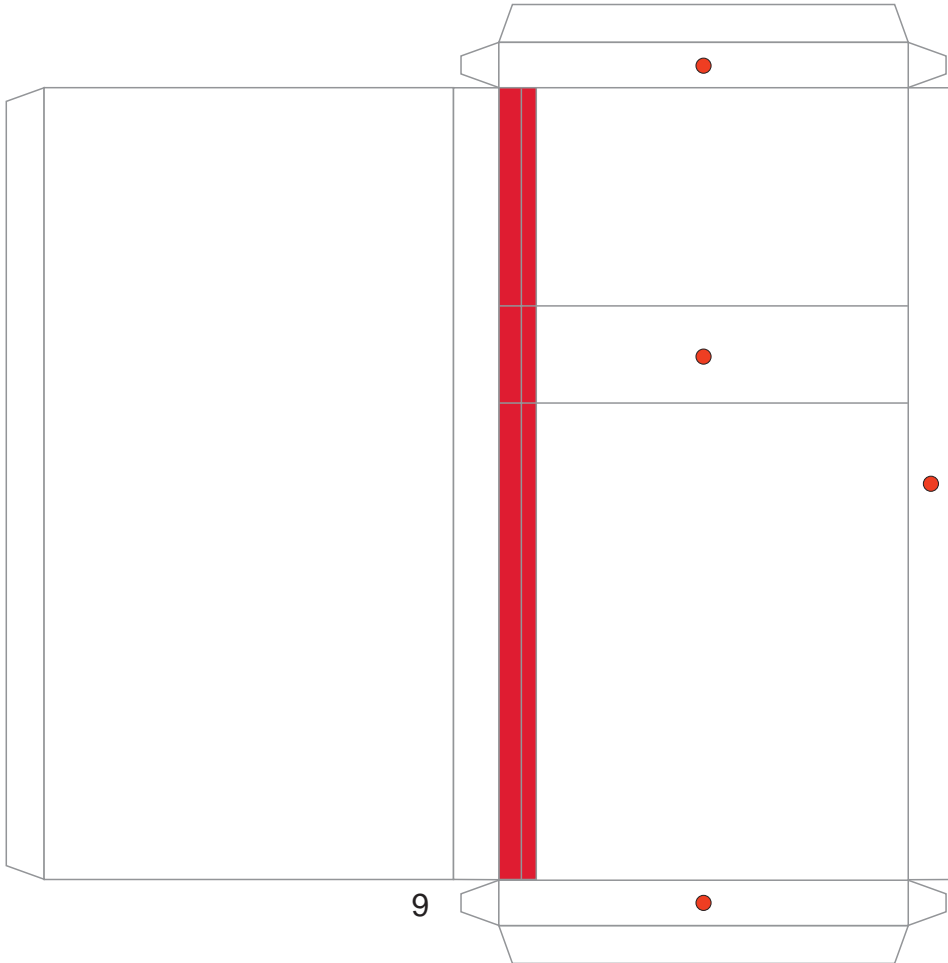

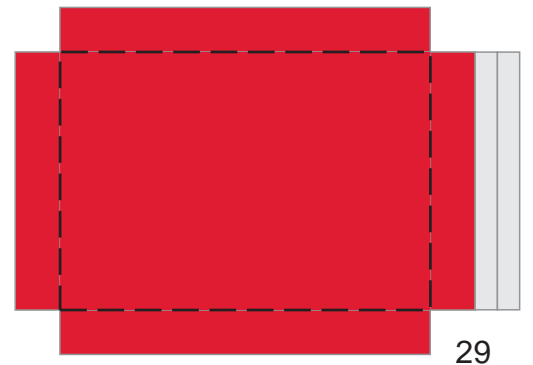
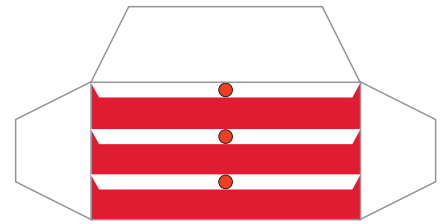
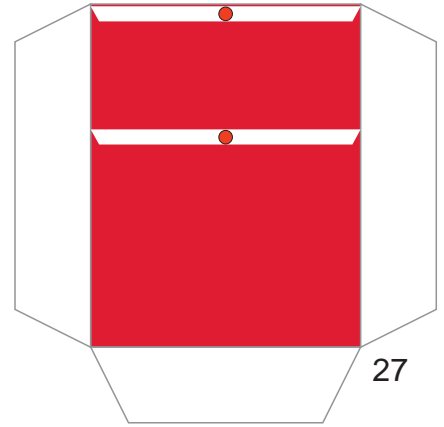
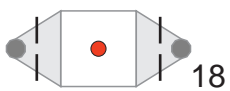
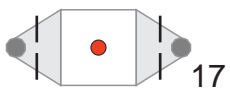
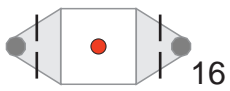
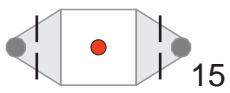
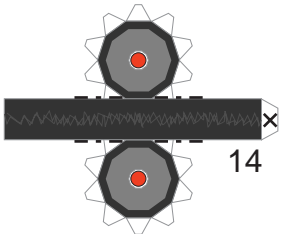
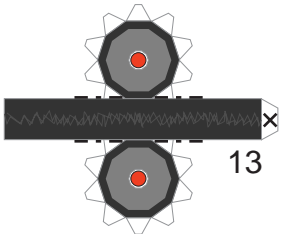
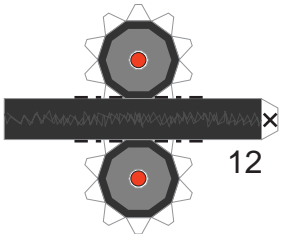
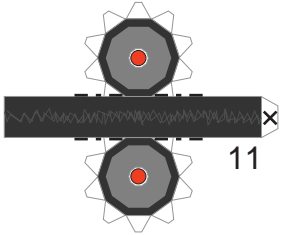

26

31

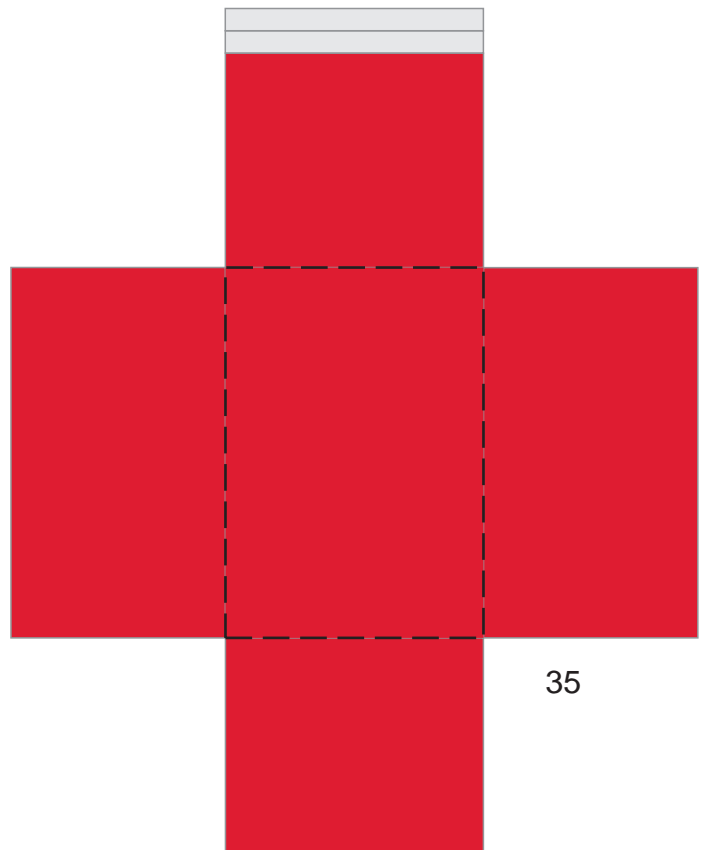
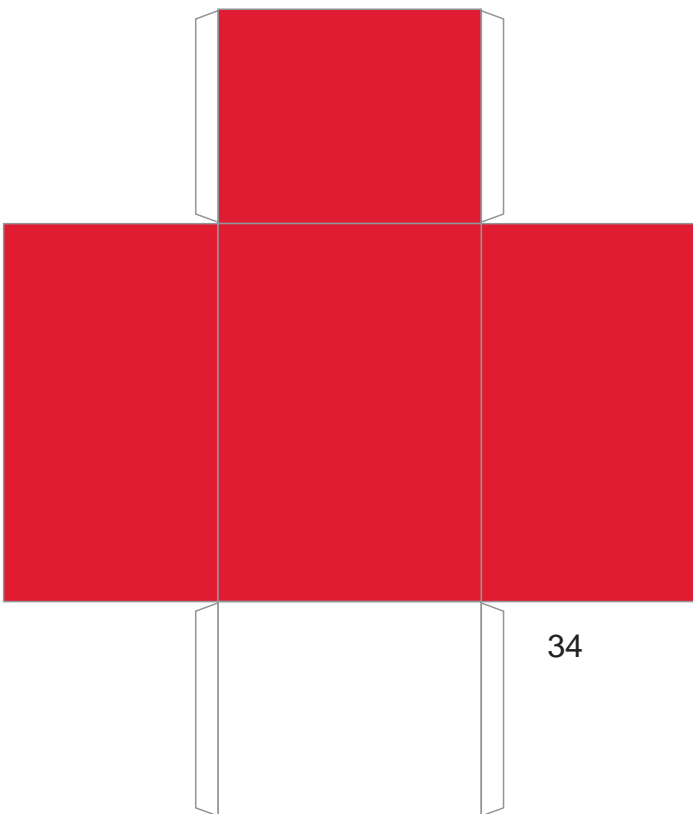
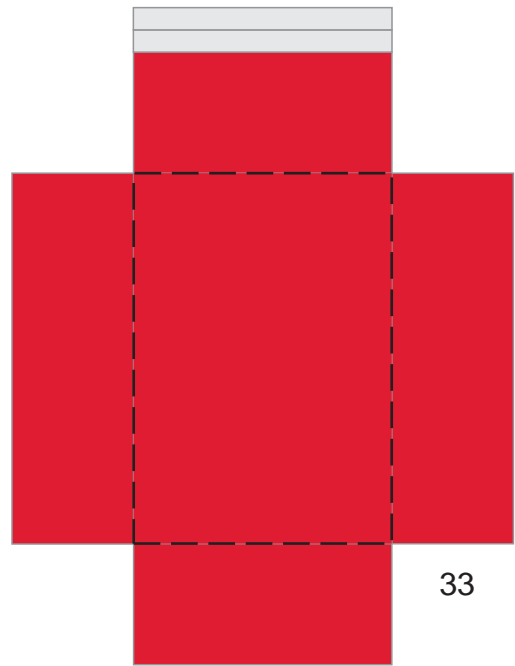
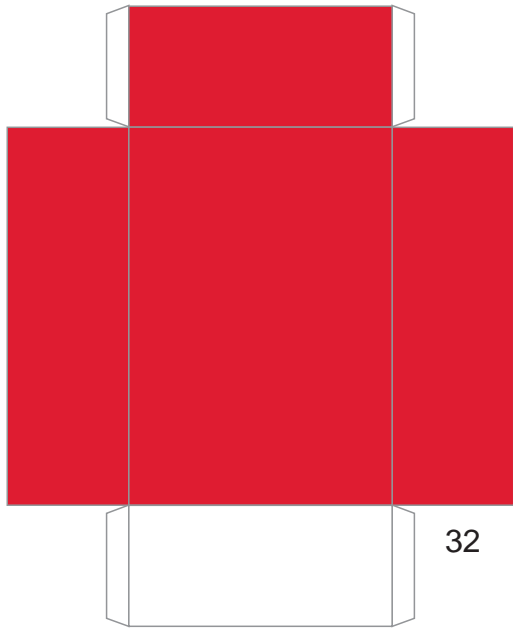

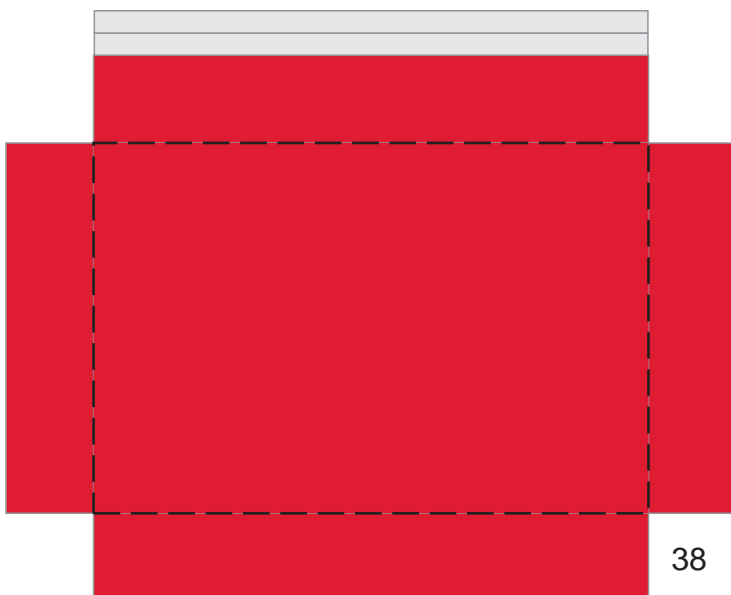
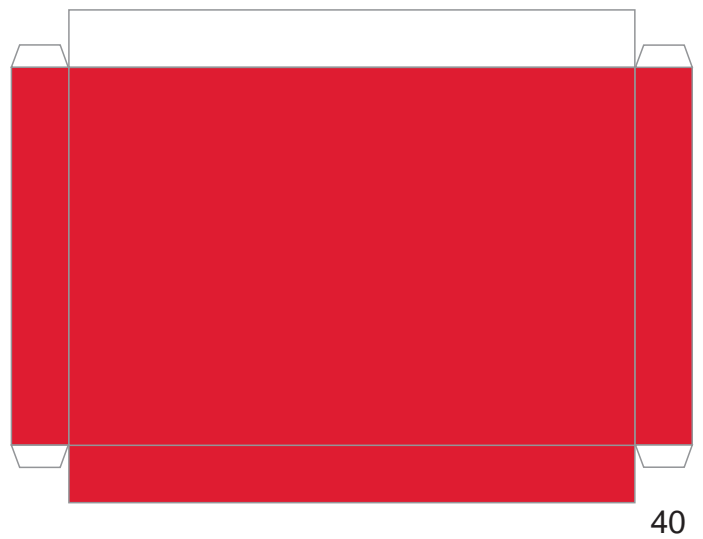
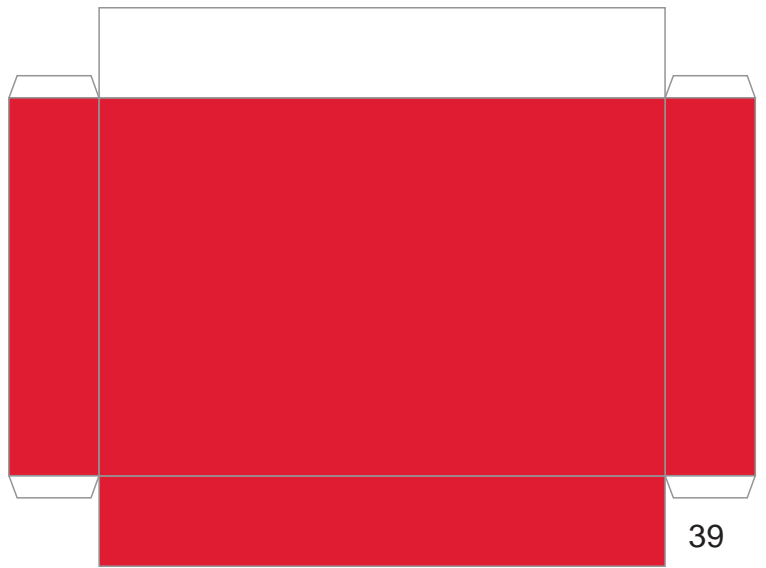

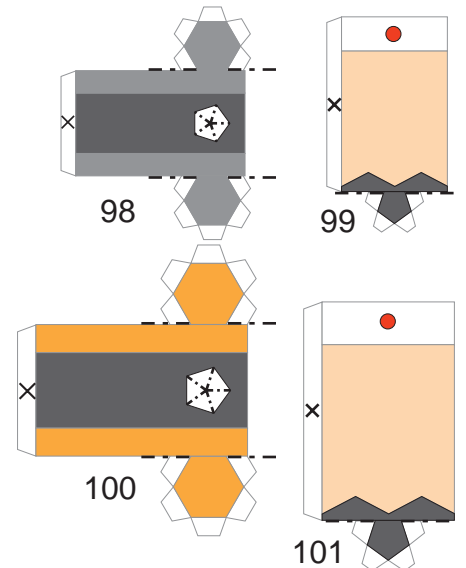
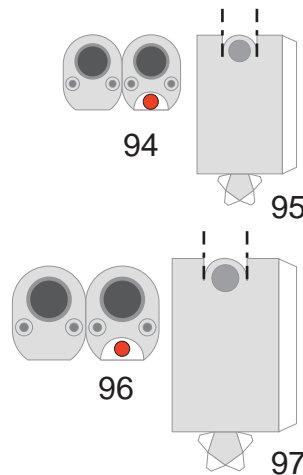
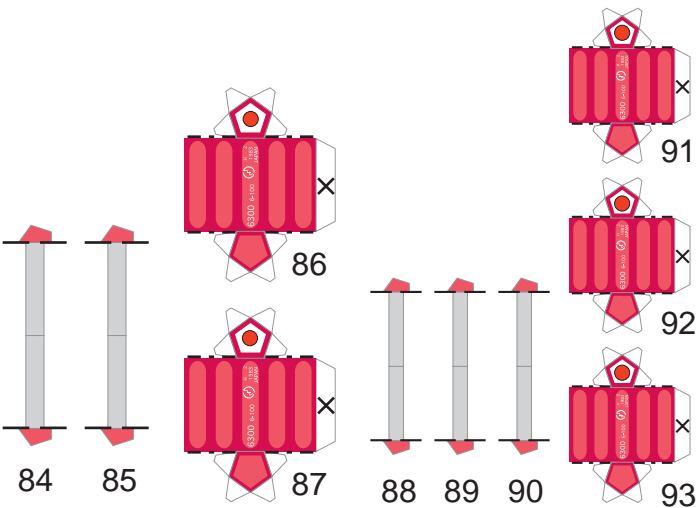
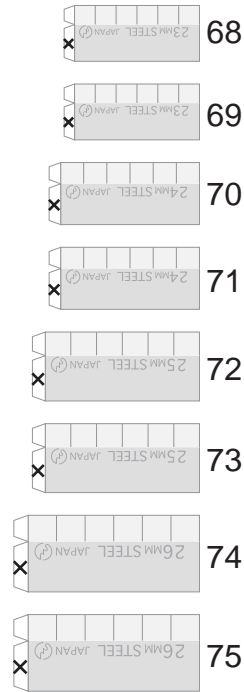
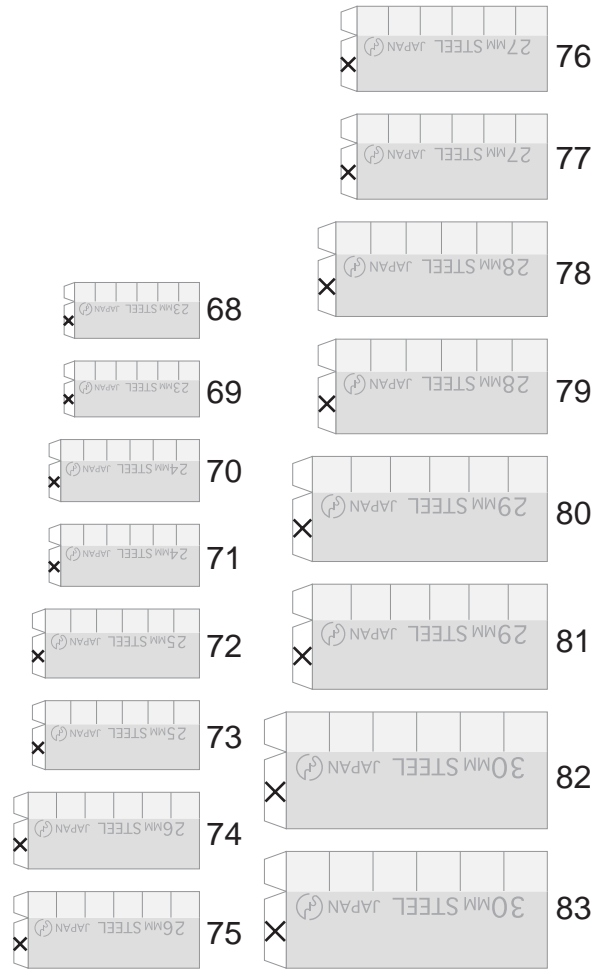
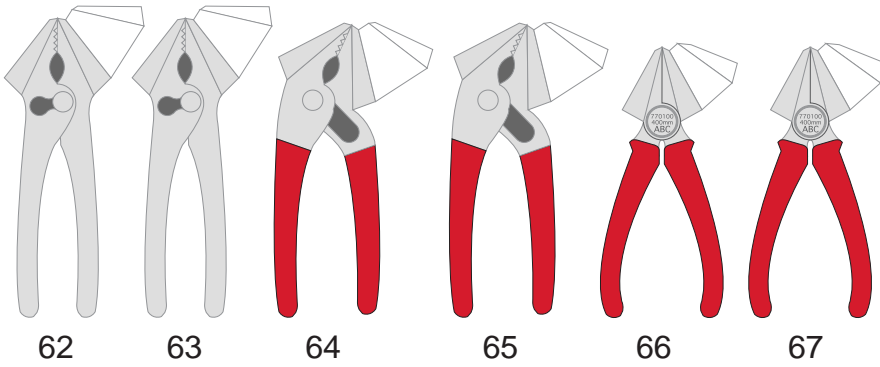
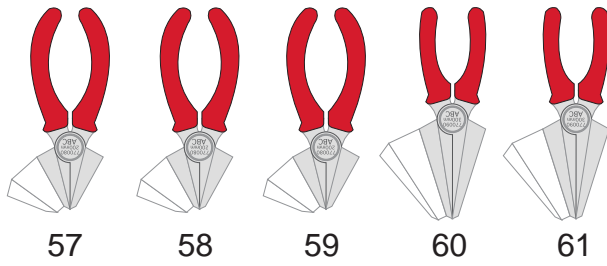
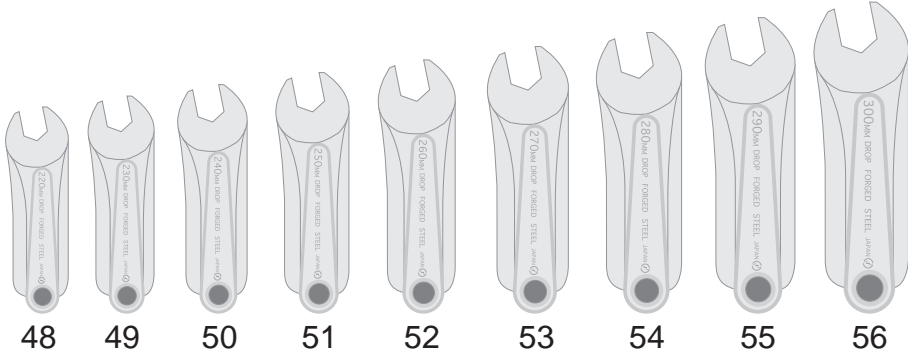
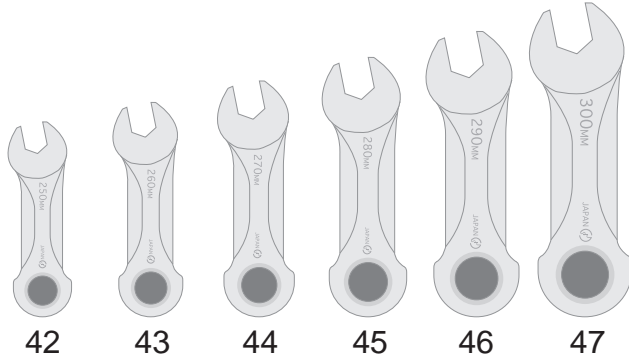

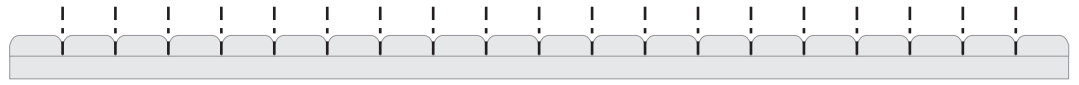

1

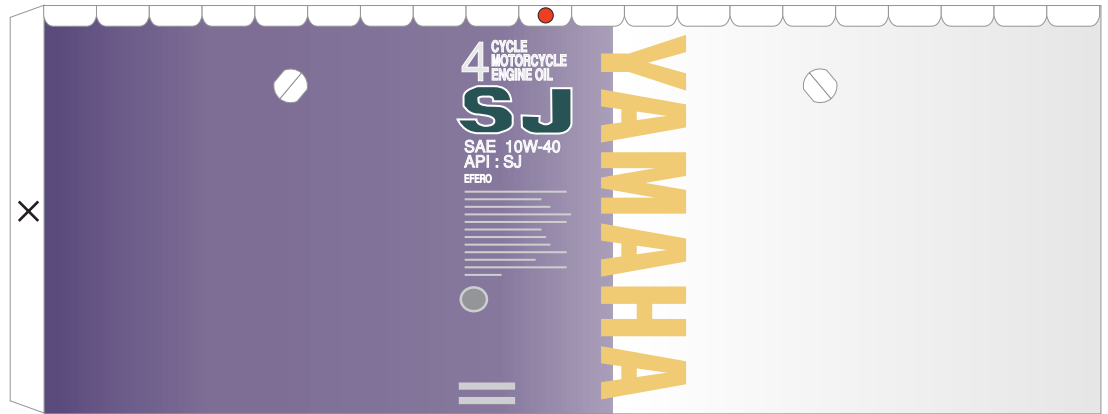

2

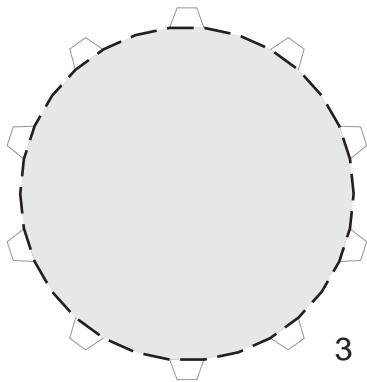

3

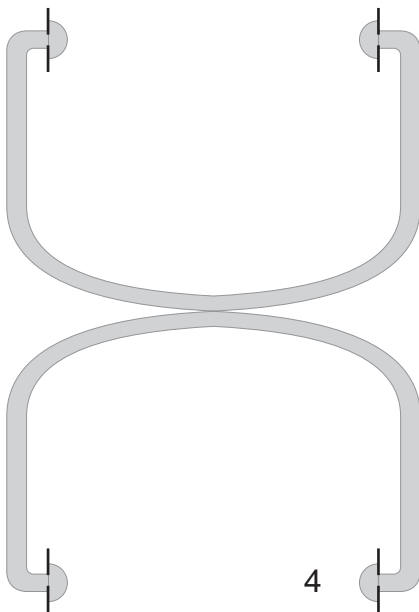
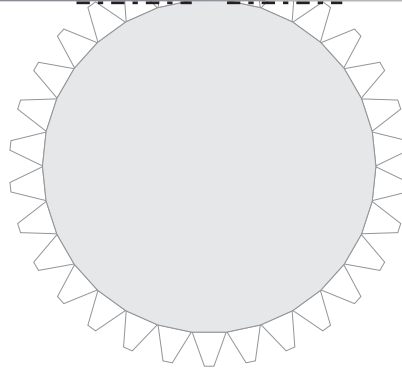

4

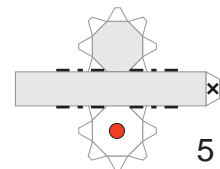

5



6

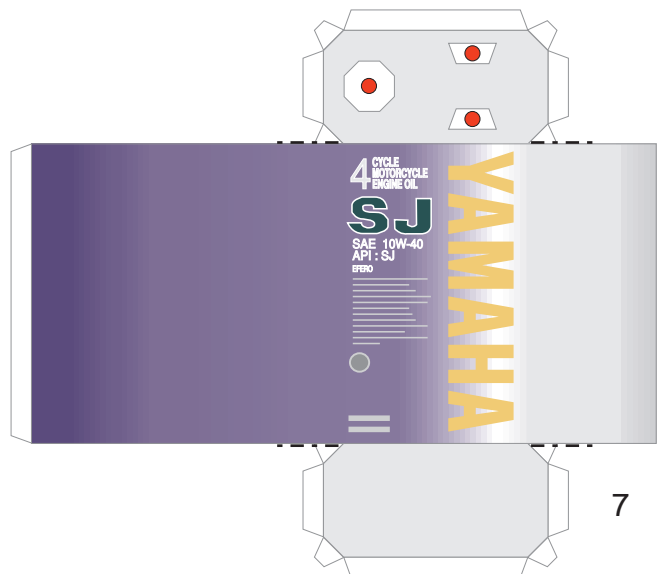

7

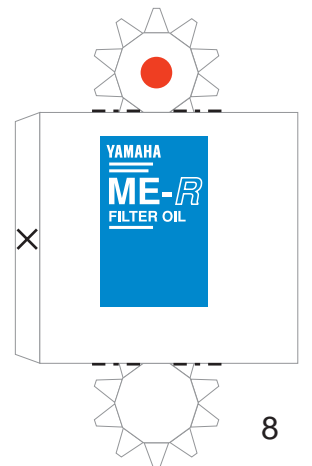
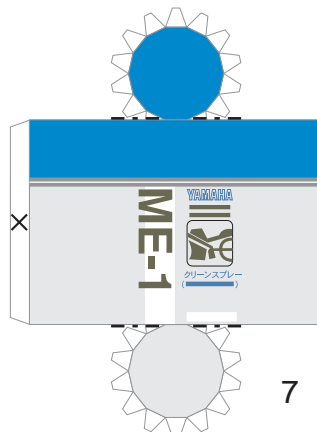
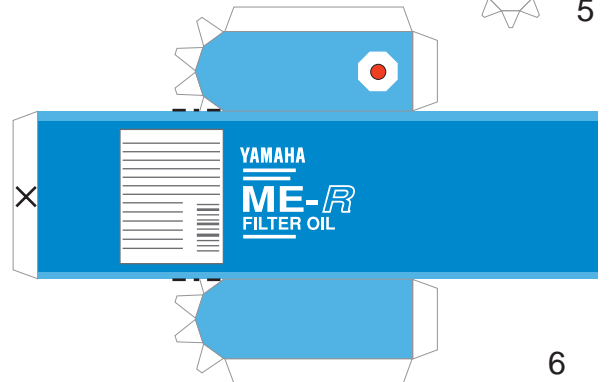
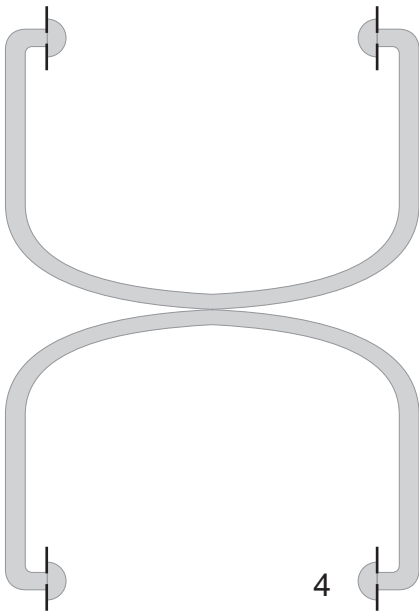
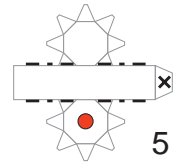
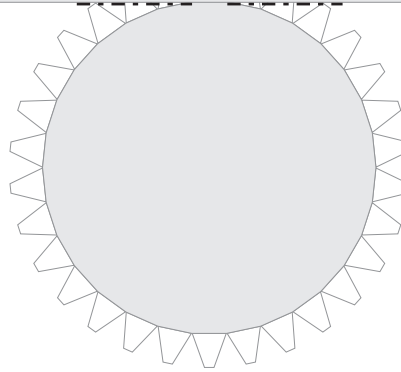
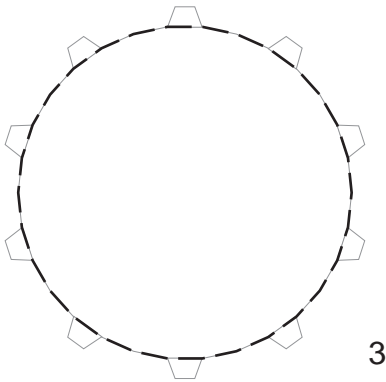
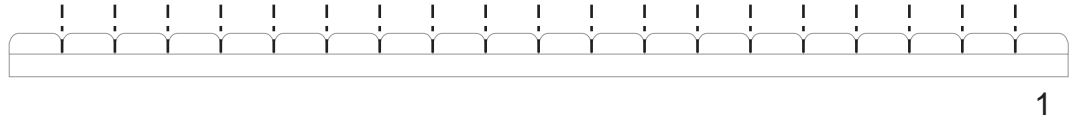

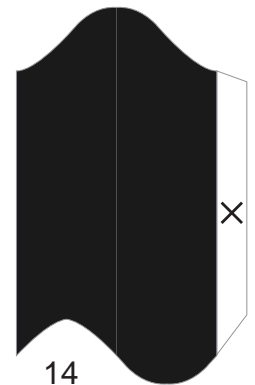
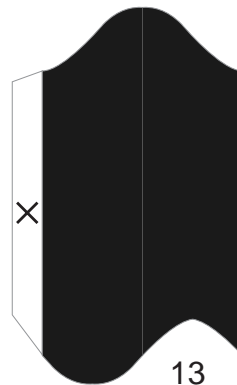
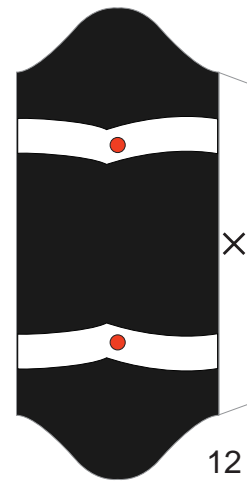
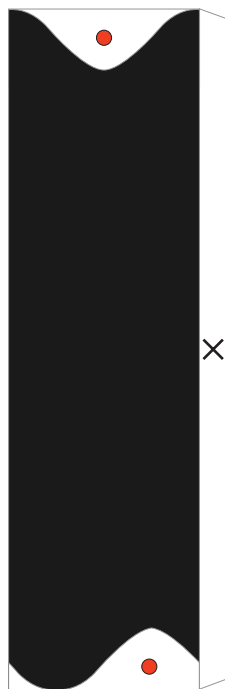
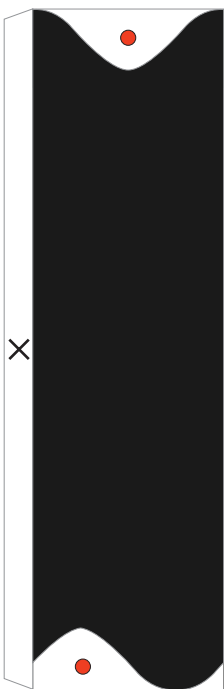
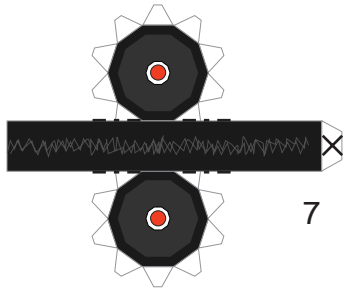
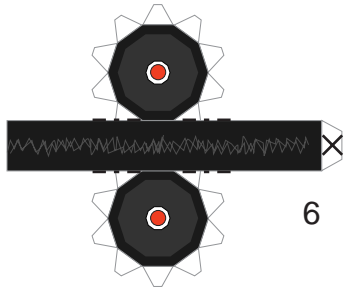
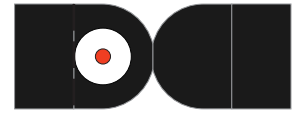
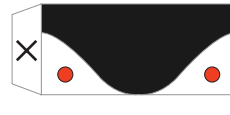
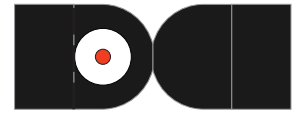
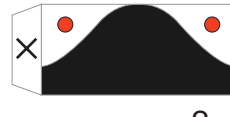
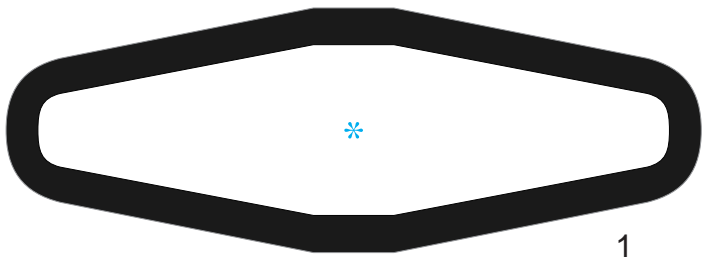

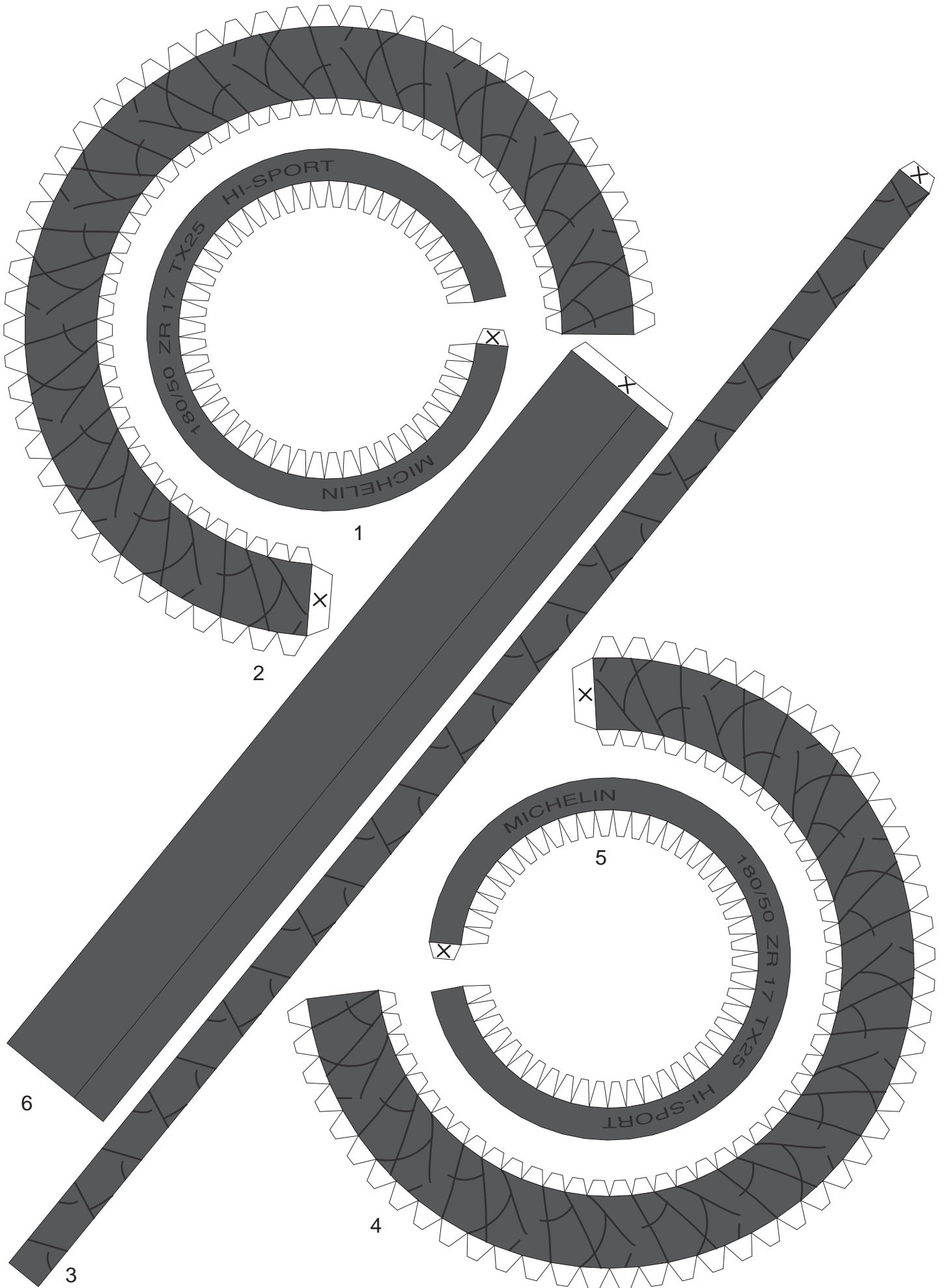



- This pattern is designed to look like a concrete wall.
Use as a garage floor or wall.
When printing or photocopying, enlarge the pattern to desired size.
- * Pasting the paper walls to cardboard is recommended for reinforcement.