

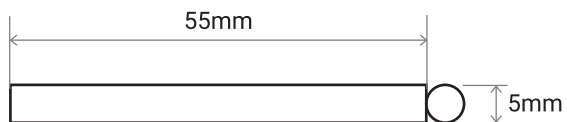

**A** パッドピン 厚さ 5mm

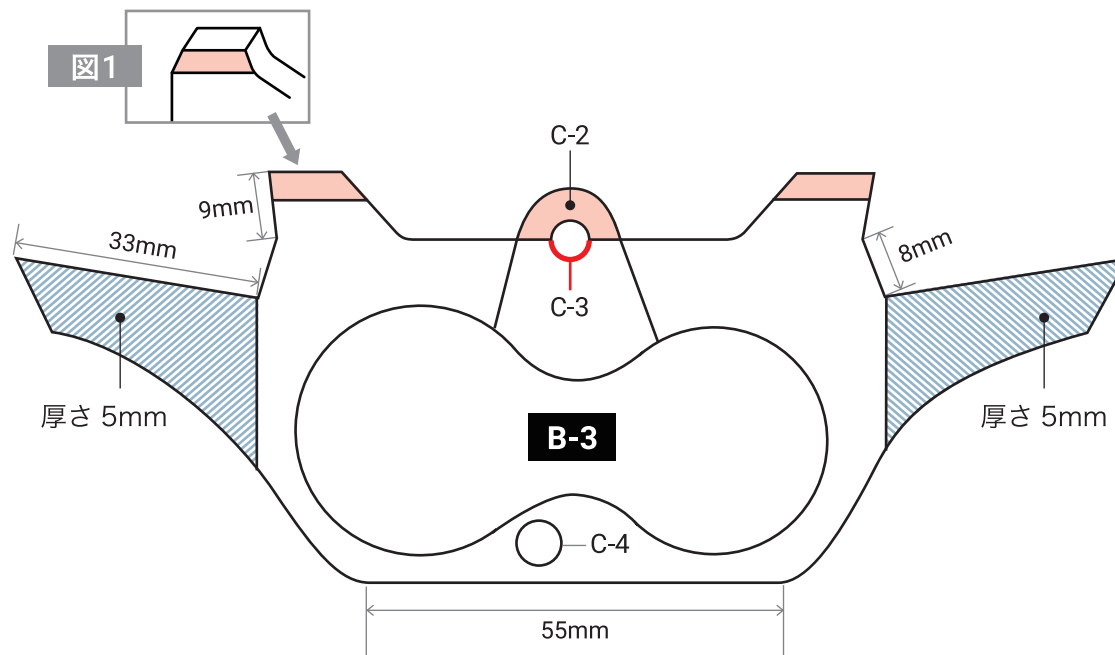

**C** キャリパーボディー 厚さ 9mm



**B-2**

**B**

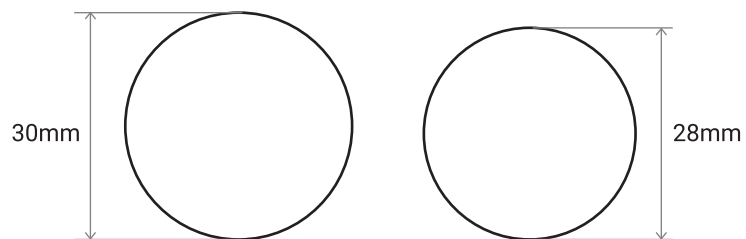

**B-3** ピストンボア

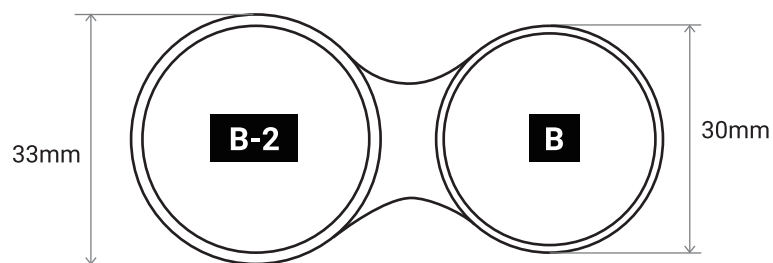

**C-2** 厚さ 5mm

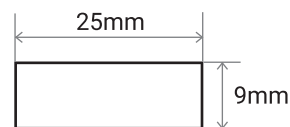

**D** 厚さ 25mm

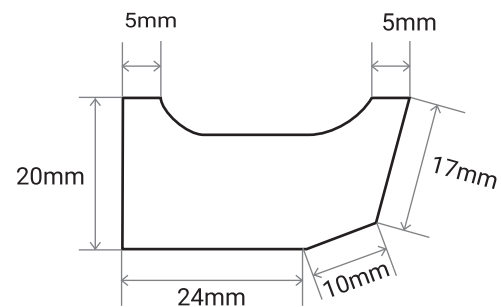

**E** 厚さ 5mm × 4

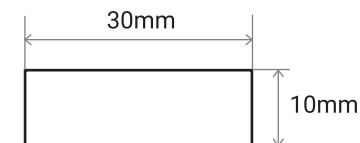



**切-1**

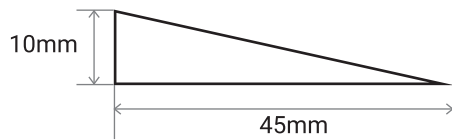

**切-3**

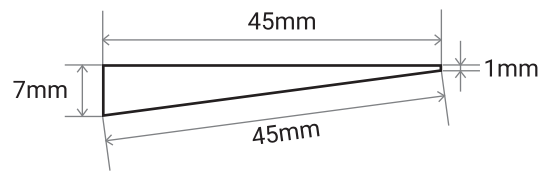

**切-2**

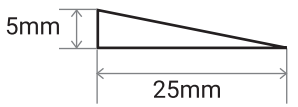

**切-4**

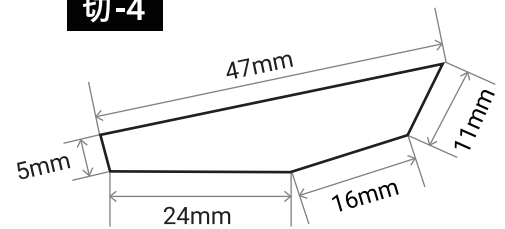

**F** キャリパーボディー 厚さ 5mm

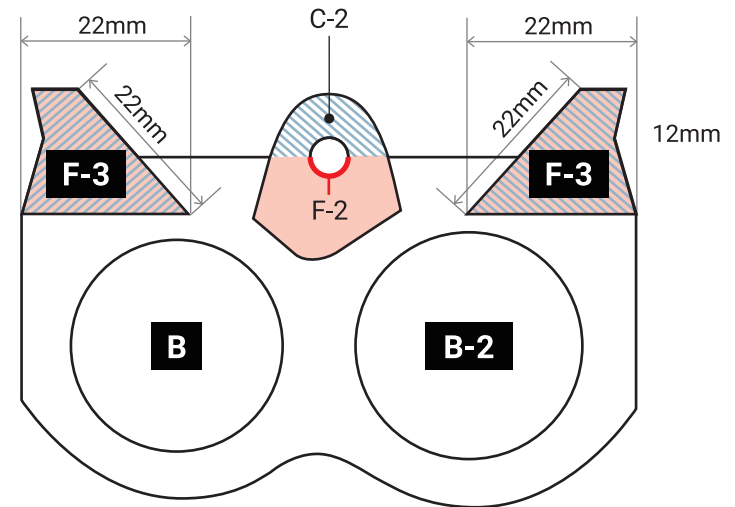

**H** バンジョーボルト穴 厚さ 4mm

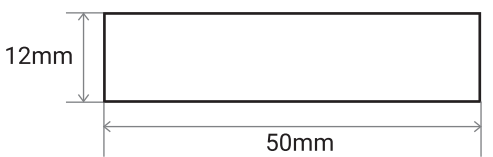

**I**

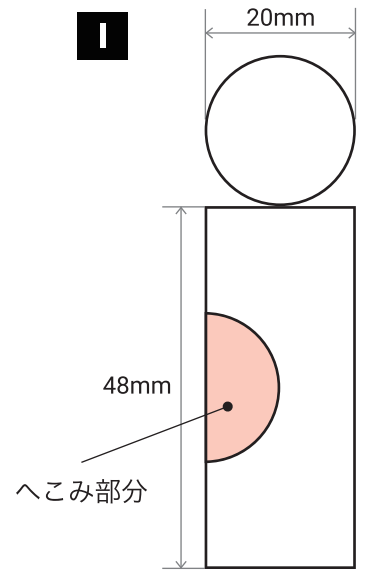

**I-2** 厚さ 3mm



**H-2** バンジョーボルト穴

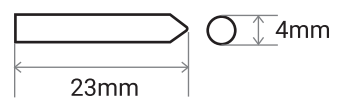

**J** 厚さ 3mm

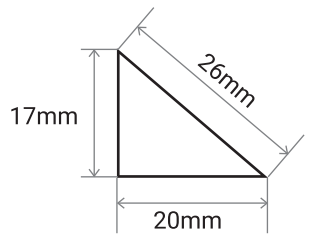

**K** 厚さ 5mm

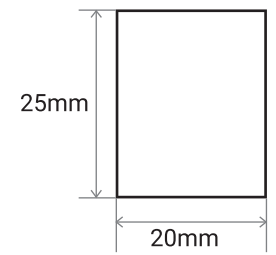



**G-1** 厚さ 5mm



**G-2** 厚さ 5mm



**G-3** 厚さ 5mm

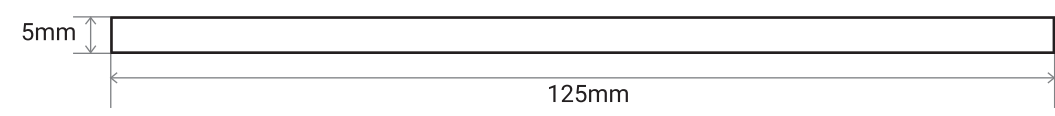

**G-4** 厚さ 5mm

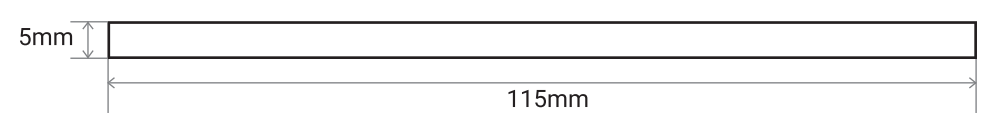

**L** ブレーキパッド  
厚さ 4mm

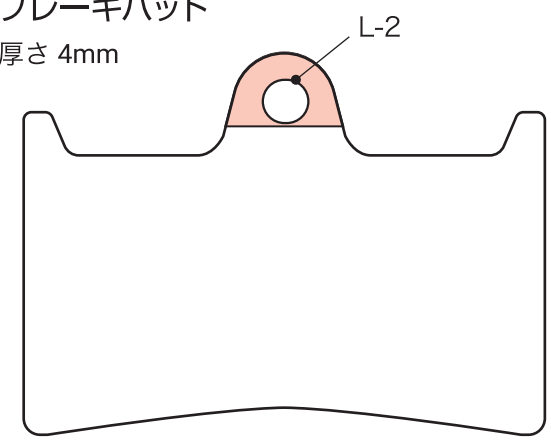

摩擦材

**L-2** 厚さ 3mm

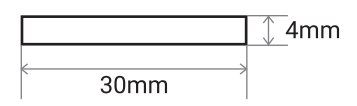

**L-3** 厚さ 4mm

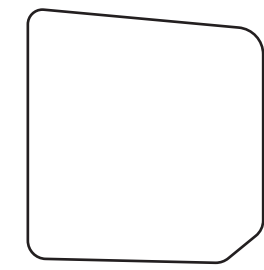

**参考** ブレーキパッドに  
摩擦材をつけた状態

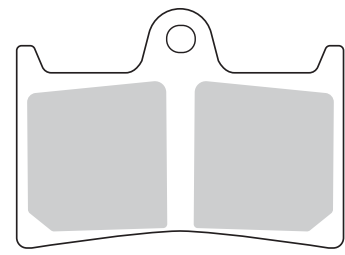



参考図

図2



図3



図4

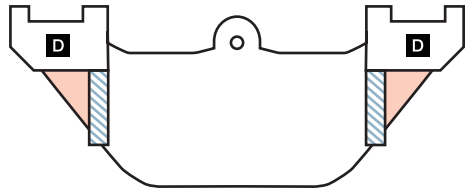

図5

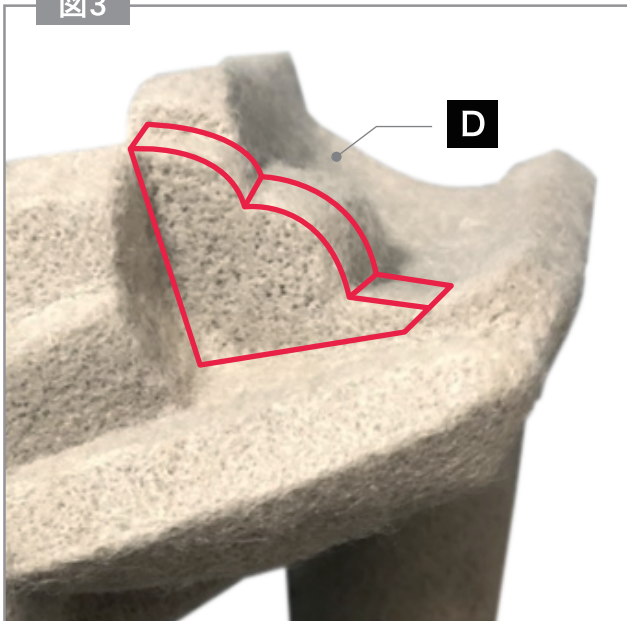

図6



図9

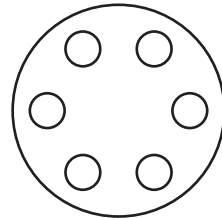

図7

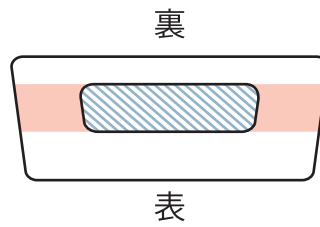

図8



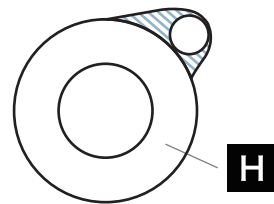

左  
➔

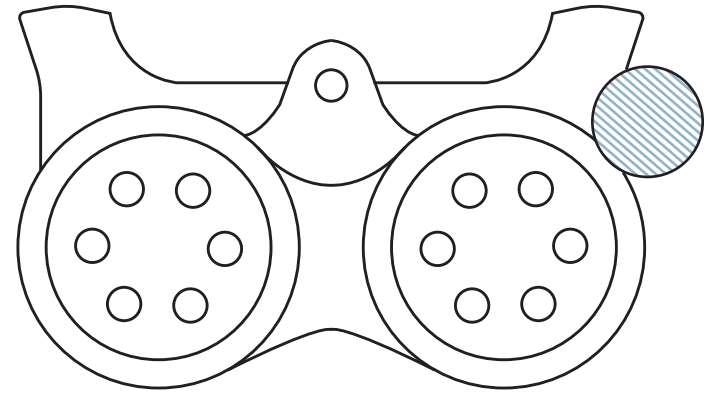
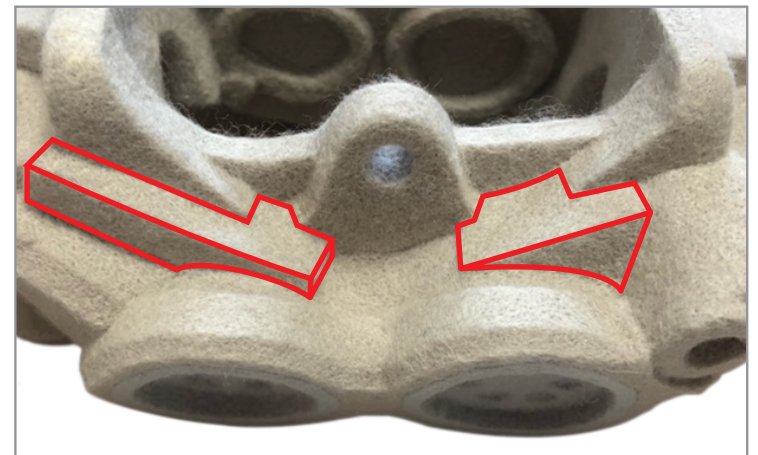
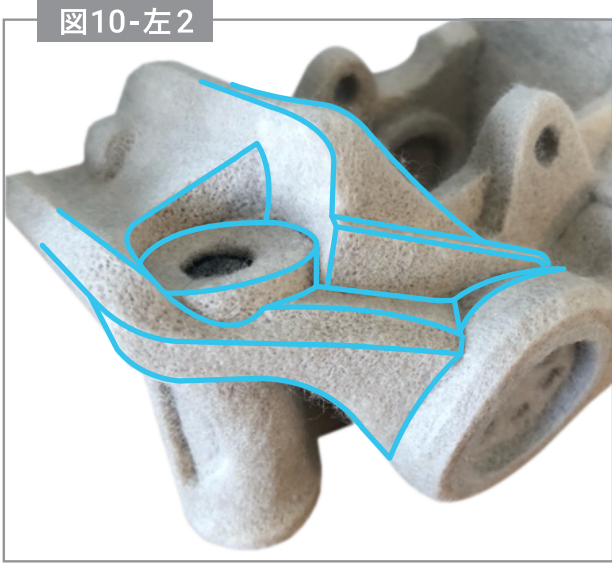

右  
➔

