

LBAR05

Basic model

Motor-less Single Axis Actuator

Rod type



Ordering method

LBAR05

Model	Lead	Shape	Motor specification	Stroke
	20: 20 mm 10: 10 mm 5: 5 mm	S: Straight A: Bending	Y: Y specification (see below) P: P specification (see below) A: A specification (see below) S: S specification (see below) N: N specification (see below)	50 to 600 (50 mm pitch)

[Caution]

This system is provided as mechanical actuator unit and not including any adopters or electric components. Motor, driver and other components required for installation are the user's responsibility. Refer to user's manual for installation details. Refer to your motor manual for tuning or adjustment. Vibration or resonance from actuator will affect service life of actuator. The product performance may not be satisfied depending on the compatible motor. For special parts for motor installation, install and adjust on your side.

Specifications

Applicable motor	100 W		
Repeatability ^{Note 1}	+/-0.01 mm		
Deceleration mechanism	Shifting position ball screw φ 12 (C7 class)		
Stroke	50 mm to 600 mm (50 mm pitch)		
Maximum speed ^{Note 2 Note 3}	1200 mm/sec	600 mm/sec	300 mm/sec
Ball screw lead	20 mm	10 mm	5 mm
Maximum payload ^{Note 3}	Horizontal	15 kg	25 kg
	Vertical	4 kg	8 kg
Max. pressing force ^{Note 3}	100 N	200 N	400 N
Rotating backlash	+/-0 °		
Maximum dimensions of cross section of main unit	W 54 mm × H 54.7 mm		
Overall length	Straight	ST + 269.5 mm	
	Bending	ST + 249 mm	
Using ambient temperature and humidity	0 to 40 °C, 35 to 80 %RH (non-condensing)		

Note 1. Positioning repeatability in one direction.

Note 2. When a moving distance is short and depending on an operation condition, it may not reach the maximum speed.

If the effective stroke exceeds 350 mm, the ball screw may resonate. (Critical speed)

At this time, make the adjustment to decrease the speed while referring to the maximum speed shown in the table.

Note 3. The described specifications may not be satisfied depending on the installed motor.

Note. See P.136 for acceleration/deceleration and inertia moment.

Applicable motor

Applicable servo motor

Specification	Flange size	□ 40
	Wattage	100 W

Note. Motor models marked with * may not be 50W, but can be installed.

Motor specification	Manufacturer	Model
Y	Yaskawa Electric Corp.	SGMJV-01
		SGMJ7-01
	Keyence Corp.	SV- □ 010
		SV2- □ 010
	Mitsubishi Electric Corp.	HF-KP13
		HG-KR13
		HK-KT13
	Omron Electronics	R88M-K10030
		R88M-1M10030
	Panasonic Corp.	MHMF01
	Sanyo Denki	R2 □ A04010
	Tamagawa Seiki	TSM3104
	Delta Electronics	ECMA-C10401
	Fanuc Corp.	βIS0.3/5000
Kingservo	KSMA01LI □ S	
	KSMA01LG	
Siemens	1FK2102-1AG	
	1FL6024-2AF	
Schneider	BCH2MB013	
Beckhoff	AM3012C*	
Allen-Bradley	TLY-A130*	
P	Panasonic Corp.	MSMD01
		MSMF01

Applicable stepping motor

Specification	Flange size	□ 42
---------------	-------------	------

Motor specification	Manufacturer	Model
A	Oriental Motor	AZM46
		ARM46
		RKS54
S	Oriental Motor	AZM48
N	NEMA standard	NEMA17

Note. Be aware that the dimensions of the NEMA standard motor may vary depending on the manufacturer.

Note. For the motor specifications A, S, and N, the parts dedicated for bending cannot be used.

Access the website below.



▶ The cycle time simulation can be performed easily from our member site. For details, see P.16.

■ Rod deflection amount (reference value)

For the deflection amount per stroke, see the graph below.

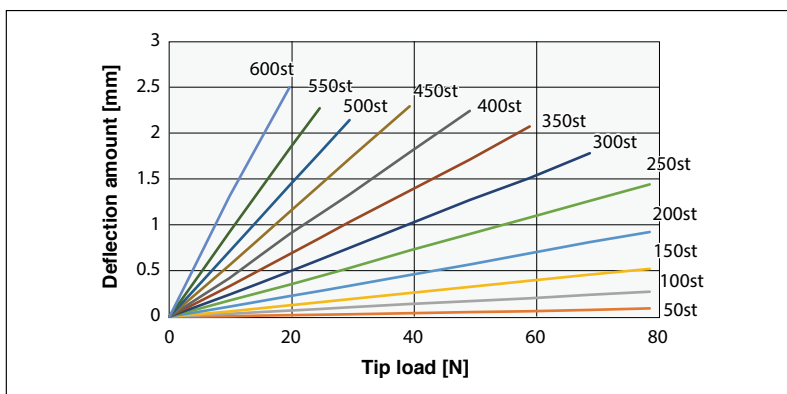

■ Allowable payload

For the allowable payload per offset amount, see the graph below.

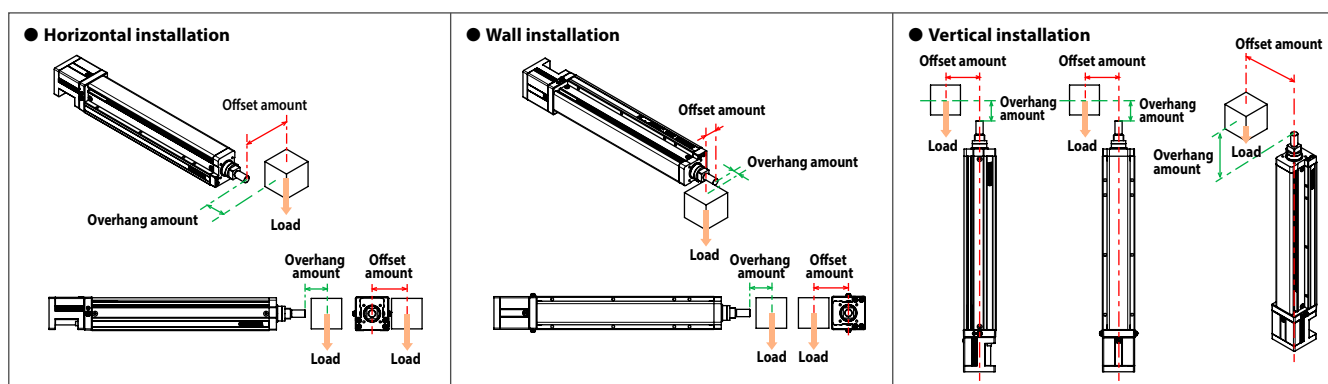

Note 1. When transferring an object with a weight exceeding the following, use an external support guide. Install the support guide flexibly so that no unnecessary load is applied to the rod.
 Note 2. The values are when the service life of the guide is 5000 km.

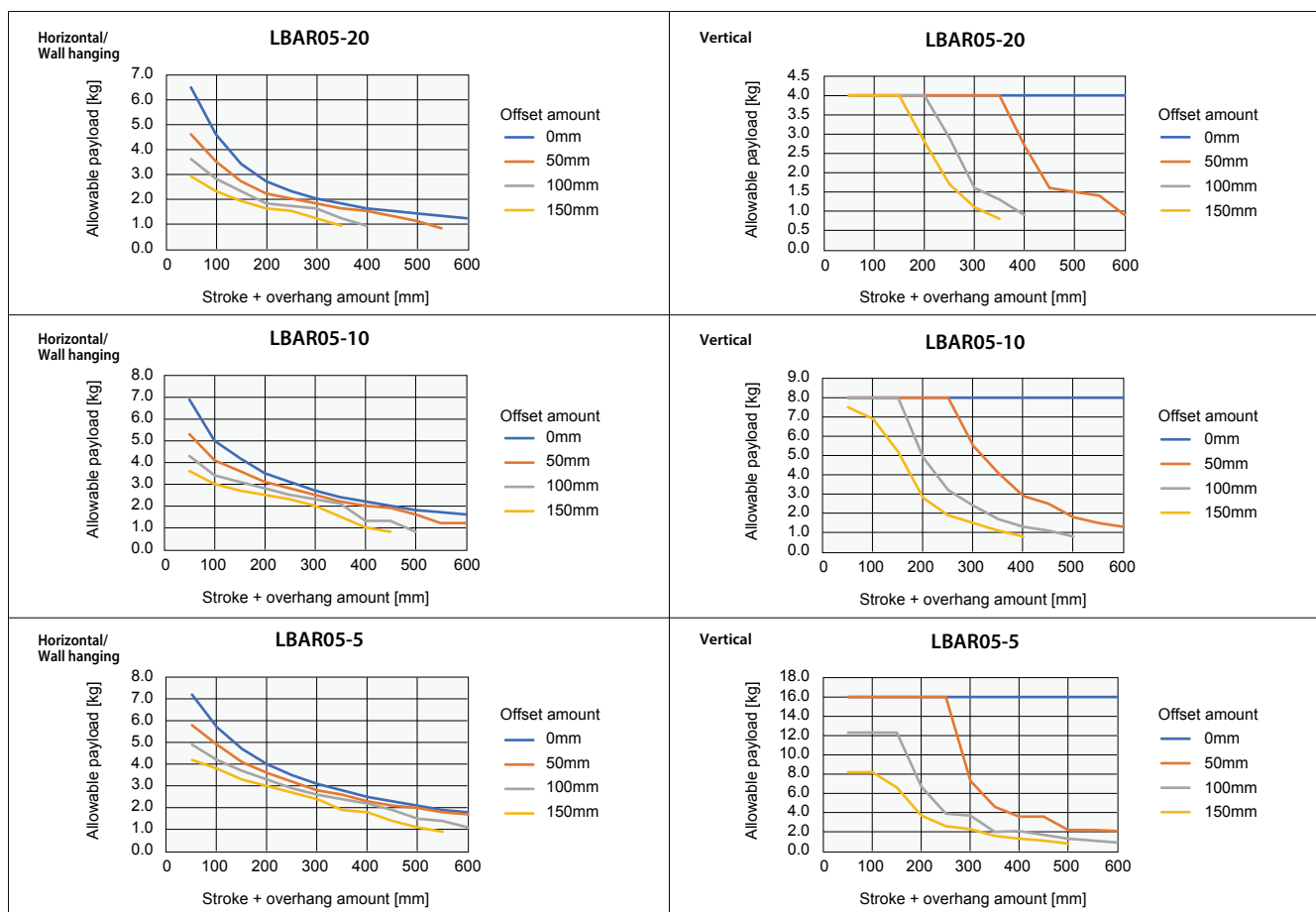

Features
 Motorless
 Silver type
 Basic model
 LBAS
 Motorless
 Silver type
 Advanced model
 LGXS
 Motorless
 Rod type
 Basic model
 LBAR
 Motorless
 Silver type
 Basic model
 ABAS
 Motorless
 Silver type
 Advanced model
 AGXS
 Motorless
 Rod type
 Basic model
 ABAR
 Acceleration/Deceleration
 Inertia Moment
 Option
 Single axis
 positioner
 EP-01

LBAR05 Straight type (S)

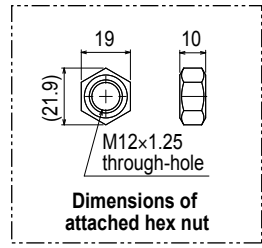
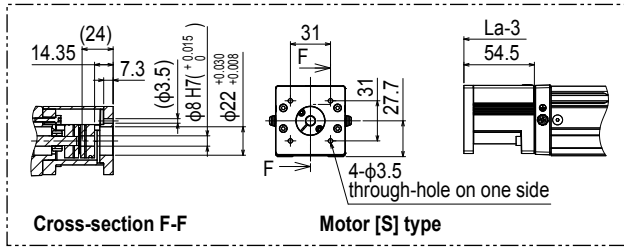
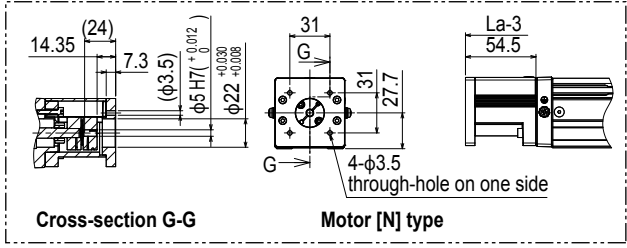
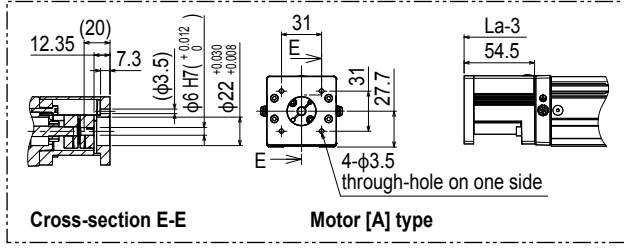
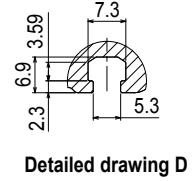
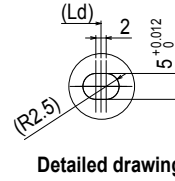
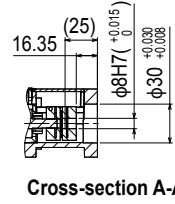
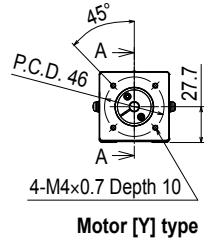
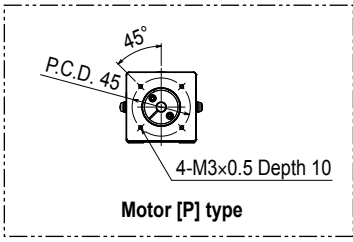
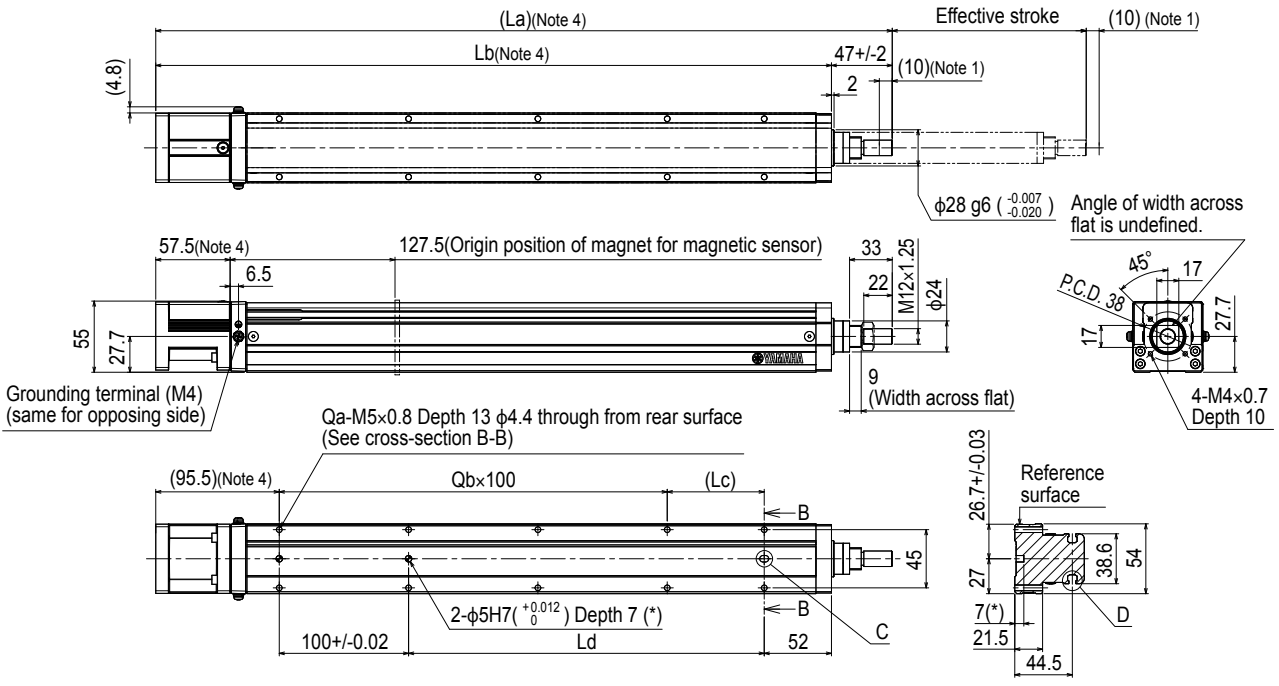

- Note 1. Stop positions are determined by the mechanical stoppers at both ends.
- Note 2. Please perform installation and adjustment on the special parts for motor installation by the customer. For detail, refer to the manual.
- Note 3. For the installation through hole, the length under head << 30 mm or more >> is recommended for the hex socket head bolts <M4 × 0.7>. In the installation tap hole, the length under head << thickness of stand +10 mm or less >> is recommended for the hex socket head bolts <M5 × 0.8> used to install the main unit.
- Note 4. For the motor specifications A, S, and N, the dimensions are that those stated in the table <<-3 mm>>.
- Note 5. Grease gun nozzle (recommended) (see P.143 for detail)
Part number: KFU-M3861-00

Effective stroke	50	100	150	200	250	300	350	400	450	500	550	600
La	319.5	369.5	419.5	469.5	519.5	569.5	619.5	669.5	719.5	769.5	819.5	869.5
Lb	272.5	322.5	372.5	422.5	472.5	522.5	572.5	622.5	672.5	722.5	772.5	822.5
Lc	25	75	25	75	25	75	25	75	25	75	25	75
Ld	25	75	125	175	225	275	325	375	425	475	525	575
Qa	6	6	8	8	10	10	12	12	14	14	16	16
Qb	1	1	2	2	3	3	4	4	5	5	6	6
Weight (kg)	1.7	1.9	2	2.2	2.4	2.6	2.7	2.8	2.9	3	3.2	3.4
Maximum speed (mm/sec)	Lead 20	1200						960	780	600	480	420
	Lead 10	600						480	390	300	240	210
	Lead 5	300						240	195	150	120	105
Speed setting	-						80%	65%	50%	40%	35%	

LBAR05 Bending type (A)

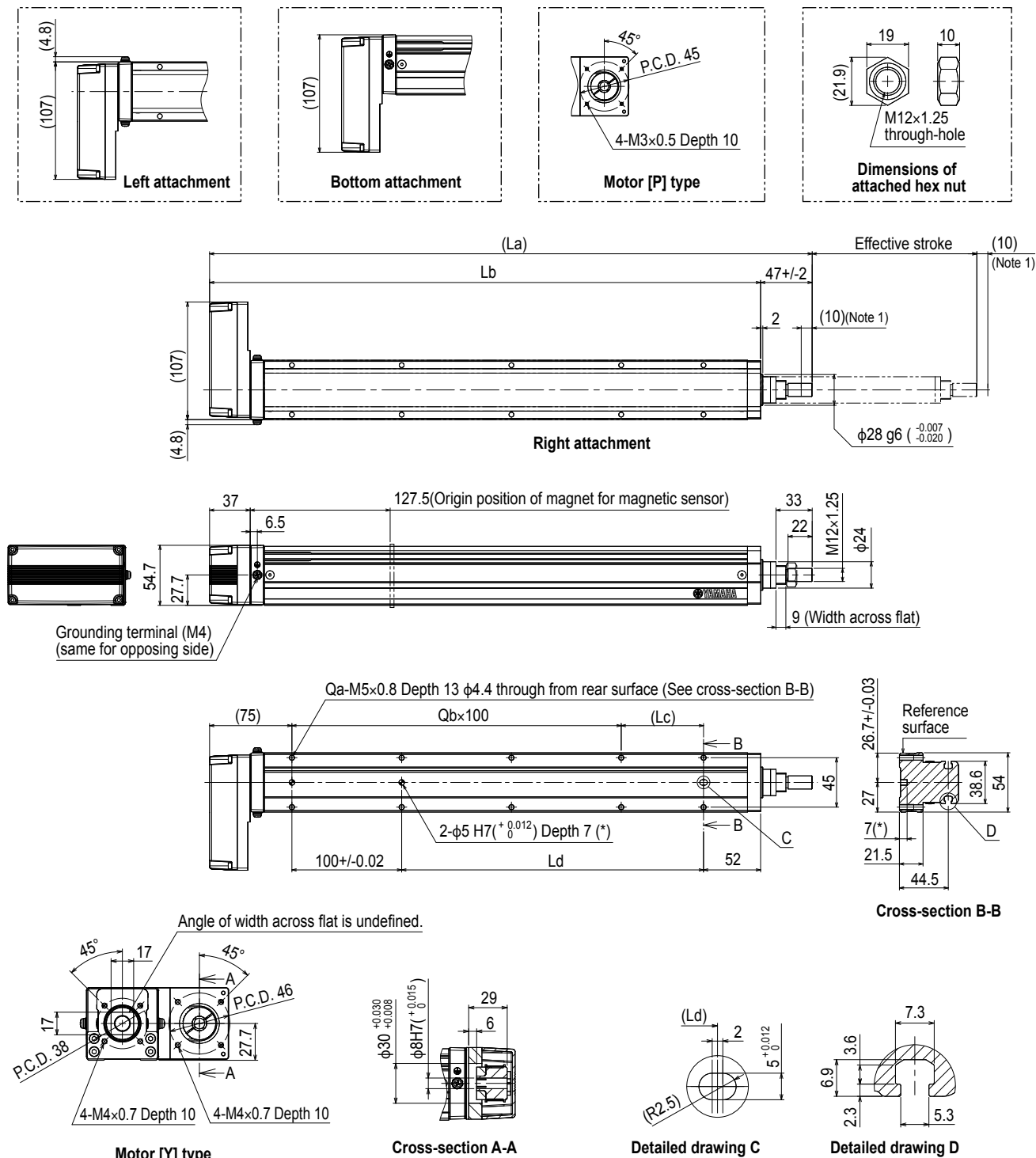

Note 1. Stop positions are determined by the mechanical stoppers at both ends.
 Note 2. Please perform installation and adjustment on the special parts for motor installation by the customer. For detail, refer to the manual.
 Note 3. For the installation through hole, the length under head << 30 mm or more >> is recommended for the hex socket head bolts <M4 × 0.7>. In the installation tap hole, the length under head << thickness of stand + 10 mm or less >> is recommended for the hex socket head bolts <M5 × 0.8> used to install the main unit.
 Note 4. Grease gun nozzle (recommended) (see P.143 for detail)
 Part number: KFU-M3861-00

Effective stroke	50	100	150	200	250	300	350	400	450	500	550	600
La	299	349	399	449	499	549	599	649	699	749	799	849
Lb	252	302	352	402	452	502	552	602	652	702	752	802
Lc	25	75	25	75	25	75	25	75	25	75	25	75
Ld	25	75	125	175	225	275	325	375	425	475	525	575
Qa	6	6	8	8	10	10	12	12	14	14	16	16
Qb	1	1	2	2	3	3	4	4	5	5	6	6
Weight (kg)	1.8	1.9	2.1	2.3	2.5	2.7	2.8	2.9	3	3.1	3.3	3.4
Maximum speed (mm/sec)	Lead 20	1200						960	780	600	480	420
	Lead 10	600						480	390	300	240	210
	Lead 5	300						240	195	150	120	105
	Speed setting	-						80%	65%	50%	40%	35%

Features

- Motorless
- Basic model
- LBAS
- Advanced model
- LGXS
- Motorless
- Basic model
- LBAR
- Basic model
- ABAS
- Advanced model
- AGXS
- Basic model
- ABAR
- Acceleration/Deceleration
- Inertia Moment
- Option
- Single axis positioner
- EP-01