



Articulated robots  
YA



Linear conveyor modules  
LCM100

Compact single-axis robots  
TRANSEURO



Single-axis robots  
FLIP-X

Linear motor single-axis robots  
PHASER



Cartesian robots  
XY-X

SCARA robots  
YK-X

Pick & place robots  
YP-X

CLEAN

CONTROLLER

INFORMATION

T type

F type

GF type

N type

B/R type

# SINGLE-AXIS ROBOTS

# FLIP-X

## SERIES

## CONTENTS

<ul style="list-style-type: none"> <li>■ <b>FLIP-X SPECIFICATION SHEET</b> ..... 172</li> <li>■ <b>Robot ordering method description</b> ..... 174</li> <li>■ <b>Robot ordering method terminology</b> ..... 175</li> </ul>	<ul style="list-style-type: none"> <li>F17L ..... 195</li> <li>GF17XL ..... 196</li> <li>F20 ..... 197</li> <li>F20N ..... 199</li> </ul>
<ul style="list-style-type: none"> <li><b>T TYPE FRAME-LESS STRUCTURE MODEL</b></li> <li>T4L ..... 176</li> <li>T4LH ..... 177</li> <li>T5L ..... 178</li> <li>T5LH ..... 179</li> <li>T6L ..... 180</li> <li>T9 ..... 181</li> <li>T9H ..... 182</li> </ul>	<ul style="list-style-type: none"> <li><b>N TYPE NUT ROTATION TYPE MODEL</b></li> <li>N15 ..... 200</li> <li>N15D ..... 202</li> <li>N18 ..... 204</li> <li>N18D ..... 206</li> </ul>
<ul style="list-style-type: none"> <li><b>F TYPE / GF TYPE HIGH RIGIDITY FRAME MODEL</b></li> <li>F8 ..... 183</li> <li>F8L ..... 184</li> <li>F8LH ..... 186</li> <li>F10 ..... 187</li> <li>F10H ..... 188</li> <li>F14 ..... 190</li> <li>F14H ..... 191</li> <li>GF14XL ..... 192</li> <li>F17 ..... 193</li> </ul>	<ul style="list-style-type: none"> <li><b>B TYPE TIMING BELT DRIVE MODEL</b></li> <li>B10 ..... 208</li> <li>B14 ..... 210</li> <li>B14H ..... 212</li> <li><b>R TYPE ROTATION AXIS TYPE MODEL</b></li> <li>R5 ..... 214</li> <li>R10 ..... 215</li> <li>R20 ..... 216</li> </ul>

# FLIP-X SPECIFICATION SHEET

Type	Model	Motor output (W)	Repeat-ability (mm)	Lead (mm)	Payload (kg)		Stroke (mm) and maximum speed (mm/s)																						
					Horizontal	Vertical	50	100	150	200	250	300	350	400	450	500	550	600	650	700	750	800	850	900	950	1000			
T type	T4L/T4LH	30	+/-0.02	12	4.5	1.2	720																						
				6	6	2.4	360																						
				2	6	7.2	120																						
	T5L/T5LH	30	+/-0.02	20	3	-	1200												960	840	720	660							
				12	5	1.2	800												640	560	480	440							
				6	9	2.4	400												320	280	240	220							
	T6L	60	+/-0.02	20	10	-	1333												1133	1000	866	800							
				12	12	4	800												680	600	520	480							
				6	30	8	400												340	300	260	240							
	T9	100	+/-0.01	30	15	-	1800												1440			1170			900				
				20	30	4	1200												960			780			600				
				10	55	10	600												480			390			300				
5				80	20	300												240			195			150					
T9H	200	+/-0.01	30	25	-	1800												1440			1170			900					
			20	40	8	1200												960			780			600					
			10	80	20	600												480			390			300					
			5	100	30	300												240			195			150					
F type	F8	100	+/-0.02	20	12	-	1200												1080	900	780	720	600						
				12	20	4	720												648	540	468	432	360						
				6	40	8	360												324	270	234	216	180						
	F8L	100	+/-0.01	30	7	-	1800												1530	1350	1170	1080	990	900	810				
				20	20	4	1200												1020	900	780	720	660	600	540				
				10	40	8	600												510	450	390	360	330	300	270				
				5	50	16	300												255	225	195	180	165	150	135				
	F8LH	100	+/-0.01	20	30	-	1200												1020	900	780	720	660	600	540	480			
				10	60	-	600												510	450	390	360	330	300	270	240			
				5	80	-	300												255	225	195	180	165	150	135	120			
	F10	100	+/-0.01	30	15	-	1800												1440			1170			900				
				20	20	4	1200												960			780			600				
10				40	10	600												480			390			300					
5				60	20	300												240			195			150					
F10H	200	+/-0.01	30	25	-	1800												1440	1260	1080	900	720	630						
			20	40	8	1200												960	840	720	600	480	420						
			10	80	20	600												480	420	360	300	240	210						
			5	100	30	300												240	210	180	150	120	105						
F14	100	+/-0.01	30	15	-	1800												1440			1170			900					
			20	30	4	1200												960			780			600					
			10	55	10	600												480			390			300					
			5	80	20	300												240			195			150					
F14H	200	+/-0.01	30	25	-	1800												1440			1170			900					
			20	40	8	1200												960			780			600					
			10	80	20	600												480			390			300					
			5	100	30	300												240			195			150					
F17	400	+/-0.01	40	40	-	2400												1920			1680								
			20	80	15	1200												960			840								
			10	120	35	600												480			420								
F17L	600	+/-0.02	50	50	10																								
F20	600	+/-0.01	40	60	-	2400												1920			1680								
			20	120	25	1200												960			840								
			10	-	45	600												480			420								
F20N	400	+/-0.04	20	80	-																								
GF type	GF14XL	200	+/-0.01	20	45	-																							
	GF17XL	400	+/-0.01	20	90	-																							
N type	N15	400	+/-0.01	20	50	-																							
	N15D	400	+/-0.01	20	50	-	1200																						
	N18	400	+/-0.01	20	80	-																							
	N18D	400	+/-0.01	20	80	-																							
B type	B10	100	+/-0.04	-	10	-																							
	B14	100	+/-0.04	-	20	-																							
	B14H	200	+/-0.04	-	30	-																							

Type	Model	Motor output (W)	Repeat-ability (sec)	Speed reduction ratio	Maximum speed (°/sec)	Detailed info page
R type	R5	50	+/-30	1/50	360	P.214
	R10	100	+/-30	1/50	360	P.215
	R20	200	+/-30	1/50	360	P.216

### ⚠ Precautions for use

- **Handling**  
Fully understand the contents stated in the "FLIP-X Series User's Manual" and strictly observe the handling precautions during operation.
- **Allowable installation ambient temperature**  
0 to 45 °C

																					Detailed info page			
1050	1100	1150	1200	1250	1300	1350	1400	1450	1500 to 1600	1650	1700	1750	1800	1850 to 2000	2050	2150	2250	2350	2400 to 2500	2550	2650 to 3050			
																						T4L: <b>P.176</b> T4LH: <b>P.177</b>		
																							T5L: <b>P.178</b> T5LH: <b>P.179</b>	
																							<b>P.180</b>	
810																							<b>P.181</b>	
540																								
270																								
135																								
810																							<b>P.182</b>	
540																								
270																								
135																								
																							<b>P.183</b>	
720																							<b>P.184</b>	
480																								
240																								
120																								
420																							<b>P.186</b>	
210																								
105																								
810																							<b>P.187</b>	
540																								
270																								
135																								
																							<b>P.188</b>	
810																							<b>P.190</b>	
540																								
270																								
135																								
810																							<b>P.191</b>	
540																								
270																								
135																								
1440		1200		960		840	720																<b>P.193</b>	
720		600		480																				
360		300		240																				
		2200			1900				1500			1200			900	800							<b>P.195</b>	
1440		1200		960		840	720																<b>P.197</b>	
720		600		480																				
360		300		240																				
									1200														<b>P.199</b>	
									1200														<b>P.192</b>	
																							<b>P.196</b>	
																							<b>P.200</b>	
																							<b>P.202</b>	
																							<b>P.204</b>	
																							<b>P.206</b>	
																							<b>P.208</b>	
																							<b>P.210</b>	
																							<b>P.212</b>	

- Articulated robots  
YA
- Linear conveyor modules  
LCM100
- Compact single-axis robots  
TRANSEVO
- Single-axis robots  
FLIP-X
- Linear motor single-axis robots  
PHASER
- Cartesian robots  
XY-X
- SCARA robots  
YK-X
- Pick & place robots  
YP-X
- CLEAN
- CONTROLLER
- INFORMATION
- T type
- F type
- GF type
- N type
- B/R type

# Robot ordering method description

In the order format for the YAMAHA single-axis robots FLIP-X series, the notation (letters/numbers) for the mechanical section is shown linked to the controller section notation.

## [Example]

### ● Mechanical ▶ F8

- Lead ▷ 20mm
- Brake ▷ Yes
- Origin position ▷ Non-motor side
- Grease ▷ Standard
- Stroke ▷ 500mm
- Cable length ▷ 3.5m

### ● Controller ▶ SR1-X

- Usable for CE ▷ Not required
- Regenerative unit ▷ Not required
- I/O selection ▷ NPN
- Battery ▷ With battery

### ● Ordering method

# F8-20-BK-Z-500-3L-SR1-X05-N-B

Mechanical section

Controller section

This page describes using the ordering form for mechanical components.

To find detailed controller information see the controller page.

SR1-X ▶ [P.518](#), TS-X ▶ [P.492](#), RDV-X ▶ [P.506](#)

## Mechanical section

### ● T type / F type (F8 / F8L / F8LH)

① Model		③ Lead designation		④ Brake		⑩ Option			⑪ Stroke		⑫ Cable length		
T4L	F8	30	30mm	No entry	No brakes	Origin position change	None	Standard	Grease type	None	Standard	3L	3.5m
T4LH	F8L	20	20mm	BK	Brakes provided	Z		Non-motor side	GC		Clean	5L	5m
T5L	F8LH	12	12mm									10L	10m
T5LH		10	10mm									3K	3.5m
T6		6	6mm									5K	5m
T9		5	5mm									10K	10m
T9H		2	2mm										

### ● F type (Except F8 / F8L / F8LH)

① Model		③ Lead designation		④ Brake		⑥ Cable entry location		⑩ Option			⑪ Stroke		⑫ Cable length		
F10	F20	50	50mm	No entry	No brakes	No entry	Standard (S)	Origin position change	None	Standard	Grease type	None	Standard	3L	3.5m
F10H	F20N	40	40mm	BK	Brakes provided	U	From the top	Z		Non-motor side	GC		Clean	5L	5m
F14		30	30mm			R	From the right							10L	10m
F14H		20	20mm			L	From the left							3K	3.5m
F17		10	10mm											5K	5m
F17L		5	5mm											10K	10m

### ● GF type

① Model		② Model		⑤ Take out direction		③ Lead designation		⑥ Cable entry location		⑩ Option			⑪ Stroke		⑫ Cable length		
GF14XL		S	Straight model	H	Horizontal installation	20	20mm	No entry	Standard (S)	Origin position change	None	Standard	Grease type	None	Standard	3L	3.5m
GF17XL								U	From the top	Z		Non-motor side	GC		Clean	5L	5m
								R	From the right							10L	10m
								L	From the left							3K	3.5m
																5K	5m
																10K	10m

### ● N type (Single carriage)

① Model		③ Lead designation		⑦ Cable carrier entry location		⑧ Cable carrier specification		⑩ Option			⑪ Stroke		⑫ Cable length		
N15		20	20mm	RH	Horizontal, right	S	Standard cable carrier	Origin position change	None	Standard	Grease type	None	Standard	3L	3.5m
N18				LH	Horizontal, left	M	Optional cable carrier	Z		Non-motor side	GC		Clean	5L	5m
				RW	Wall, right									10L	10m
				LW	Wall, left									3K	3.5m
														5K	5m
														10K	10m

### ● N type (Double carriage)

① Model		③ Lead designation		⑤ Take out direction		⑧ Cable carrier specification		⑩ Option			⑪ Stroke		⑫ Cable length		
N15D		20	20mm	H	Horizontal installation	S	Standard cable carrier	Grease type	None	Standard				3L	3.5m
N18D				W	Wall hanging installation	M	Optional cable carrier	GC		Clean				5L	5m
														10L	10m
														3K	3.5m
														5K	5m
														10K	10m

### ● B type

① Model		⑨ Motor installation direction		⑩ Option			⑪ Stroke		⑫ Cable length	
B10		L	Motor leftward, horizontal position	Grease type	None	Standard			3L	3.5m
B14		R	Motor rightward, horizontal position	GC		Clean			5L	5m
B14H		LU	Motor leftward, upper position						10L	10m
		RU	Motor rightward, upper position						3K	3.5m
		LD	Motor leftward, lower position						5K	5m
		RD	Motor rightward, lower position						10K	10m

### ● R type

① Model		⑥ Cable entry location		⑫ Cable length	
R5		No entry	Standard (S)	3L	3.5m
R10		B	From the side	5L	5m
				10L	10m
				3K	3.5m
				5K	5m
				10K	10m

# Robot ordering method terminology

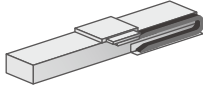
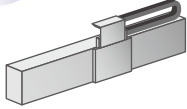
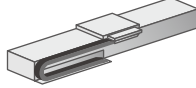
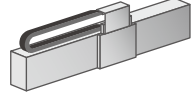
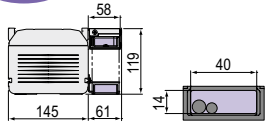
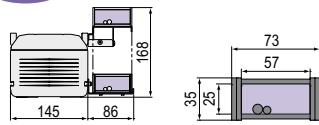
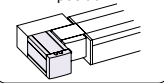
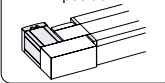
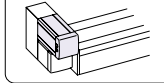
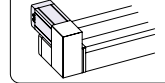
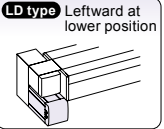
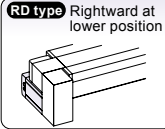
① <b>Model</b>	Enter the robot unit model.
② <b>Model</b>	Straight model only (GF type)
③ <b>Lead designation</b>	Select the ball screw lead.
④ <b>Brake</b>	Select Brake or No-brake. <b>Horizontal specs</b> : No-brake <b>Vertical specs</b> : with Brake
⑤ <b>Take out direction</b>	Select what direction to install the robot (horizontal / wall mounted).
⑥ <b>Cable entry location</b>	Select what direction to extract the robot cable connecting the robot and controller.
⑦ <b>Cable carrier entry location</b>	Select what direction to install the robot (horizontal / wall mounted) and what direction to extract the robot cable carrier.  <div style="display: flex; justify-content: space-around; align-items: flex-start;"> <div style="text-align: center;"> <p><b>RH</b> Horizontal, right</p>  </div> <div style="text-align: center;"> <p><b>RW</b> Wall, right</p>  </div> <div style="text-align: center;"> <p><b>LH</b> Horizontal, left</p>  </div> <div style="text-align: center;"> <p><b>LW</b> Wall, left</p>  </div> </div> <p>Note. Be sure to install in the direction as specified (in cable carrier take-out direction drawing and various specification drawings) individually. Installation in any other way will cause a failure. For requirement of installation in any way other than the above standard installation, please consult YAMAHA as special arrangement will be available.</p>
⑧ <b>Cable carrier specification</b>	Select the cable carrier size for the customer wiring.  <div style="display: flex; justify-content: space-around;"> <div style="text-align: center;"> <p><b>S type</b> Standard cable carrier</p>  <p>145, 61, 58, 119, 40, 14</p> </div> <div style="text-align: center;"> <p><b>M type</b> Optional cable carrier</p>  <p>145, 86, 168, 73, 57, 35, 20</p> <p>Space for optional cable for users</p> </div> </div> <p>Note. Cannot pass more than 3 urethane hoses (φ6 x 4).</p>
⑨ <b>Motor installation direction</b>	Select what direction to install the motor.  <div style="display: grid; grid-template-columns: repeat(2, 1fr); gap: 10px;"> <div style="text-align: center;"> <p><b>L type</b> Leftward at horizontal position</p>  </div> <div style="text-align: center;"> <p><b>R type</b> Rightward at horizontal position</p>  </div> <div style="text-align: center;"> <p><b>LU type</b> Leftward at upper position</p>  </div> <div style="text-align: center;"> <p><b>RU type</b> Rightward at upper position</p>  </div> <div style="text-align: center;"> <p><b>LD type</b> Leftward at lower position</p>  </div> <div style="text-align: center;"> <p><b>RD type</b> Rightward at lower position</p>  </div> </div>
⑩ <b>Option</b>	<b>Origin position change:</b> Origin point position can be changed.
	<b>Frame:</b> Hole to secure the frame can be selected. (Spot facing/tapping)
	<b>Grease type:</b> Clean grease can be selected.
⑪ <b>Stroke</b>	Select the stroke for the robot movement range.
⑫ <b>Cable length</b>	Select the robot cable length to use for connecting the robot to the controller. <b>3L</b> : 3.5m (Standard) <b>5L</b> : 5m <b>10L</b> : 10m <b>1K</b> : 1m (You can select a 1m cable only when you use T4L/T5L. Flexible cable) <b>3K</b> : 3.5m (Flexible cable) <b>5K</b> : 5m (Flexible cable) <b>10K</b> : 10m (Flexible cable)

Articulated robots YA  
 Linear conveyor modules LCM100  
 Compact single-axis robots TRANSERVO  
 Single-axis robots FLIP-X  
 Linear motor single-axis robots PHASER  
 Cartesian robots XY-X  
 SCARA robots YK-X  
 Pick & place robots YP-X  
 CLEAN  
 CONTROLLER INFORMATION  
 T type  
 F type  
 GF type  
 N type  
 B/R type

# T4L

- Origin on the non-motor side is selectable
- Controller: 24V



## Ordering method

T4L						ERCDC		
Model	Lead designation	Brake	Origin position change	Grease type	Stroke	Cable length <sup>Note 1</sup>	Controller	I/O connector specification
	12: 12mm 6: 6mm 2: 2mm	No entry: No brakes BK: Brakes provided	None: Standard Z: Non-motor side	None: Standard GC: Clean	50 to 400 (50mm pitch)	1K: 1m 3K: 3.5m 5K: 5m 10K: 10m		CN1: I/O flat cable 1m (Standard) CN2: Twisted-pair cable 2m (pulse train function)

Note 1. The robot cable is flexible and resists bending. See P.596 for details on robot cable.

## Specifications

AC servo motor output (W)	30		
Repeatability <sup>Note 1</sup> (mm)	+/-0.02		
Deceleration mechanism	Ball screw $\phi 8$		
Ball screw lead (mm)	12	6	2
Maximum speed (mm/sec)	720	360	120
Maximum payload (kg)	Horizontal		Vertical
	4.5	6	6
Rated thrust (N)	32	64	153
Stroke (mm)	50 to 400 (50mm pitch)		
Overall length (mm)	Horizontal		Vertical
	Stroke+198		Stroke+236
Maximum dimensions of cross section of main unit (mm)	W45 x H53		
Cable length (m)	Standard: 3.5 / Option: 1.5, 10		
Linear guide type	2 rows of gothic arch grooves x 1 rail		
Position detector	Resolvers <sup>Note 2</sup>		
Resolution (Pulse/rotation)	16384		

Note 1. Positioning repeatability in one direction.

Note 2. Position detectors (resolvers) are common to incremental and absolute specifications. If the controller has a backup function then it will be absolute specifications.

## Allowable overhang<sup>Note</sup>

Horizontal installation (Unit: mm)				Wall installation (Unit: mm)				Vertical installation (Unit: mm)				
Lead	Weight	A	B	Lead	Weight	A	B	Lead	Weight	C		
Lead 12	2kg	433	87	180	Lead 12	2kg	149	54	Lead 12	1.2kg	125	125
	4.5kg	223	33	75		Lead 6	4.5kg	50		1	Lead 6	2.4kg
Lead 6	3kg	515	58	135	Lead 6		3kg	107	24	Lead 6		3kg
	6kg	340	26	62		Lead 2	6kg	31	0		Lead 2	7.2kg
Lead 2	3kg	1585	58	142	Lead 2		3kg	113	24	Lead 2		3kg
	6kg	755	27	66		Lead 2	6kg	32	0		Lead 2	7.2kg

Note. Distance from center of slider top to center of gravity of object being carried at a guide service life of 10,000 km.

Note. Service life is calculated for 300mm stroke models.

## Static loading moment

(Unit: N·m)		
MY	MP	MR
15	19	18

## Controller

Controller	Operation method
ERCDC	Pulse train control / Programming / I/O point trace / Remote command / Operation using RS-232C communication

## T4L

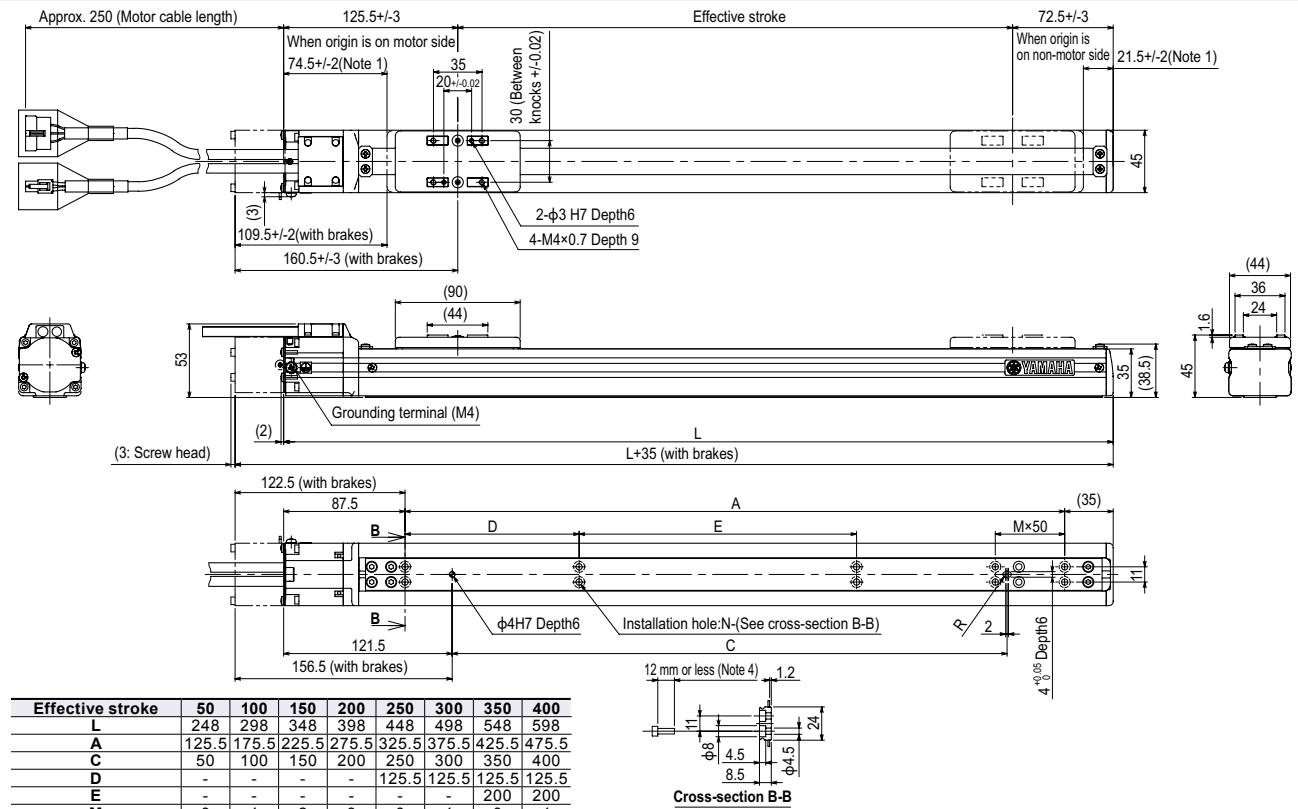

Effective stroke	50	100	150	200	250	300	350	400
L	248	298	348	398	448	498	548	598
A	125.5	175.5	225.5	275.5	325.5	375.5	425.5	475.5
C	50	100	150	200	250	300	350	400
D	-	-	-	-	125.5	125.5	125.5	125.5
E	-	-	-	-	-	200	200	-
M	0	1	2	3	0	1	0	1
N	4	6	8	10	6	8	8	10
Weight (kg) <sup>Note 3</sup>	1.1	1.2	1.4	1.5	1.6	1.7	1.8	1.9
Maximum speed for each stroke (mm/sec)	Lead 12	720						
	Lead 6	360						
	Lead 2	120						

- Note 1. Stop positions are determined by the mechanical stoppers at both ends.
- Note 2. Minimum bend radius of motor cable is R30.
- Note 3. Weight of models with no brake. The weight of brake-attached models is 0.2 kg heavier than the models with no brake shown in the table.
- Note 4. The under-head length of the hex socket-head bolt (M4x0.7) to be used for the installation work is 12mm or less.
- Note 5. External view of T4LH is identical to T4L.



### Ordering method

## T4LH

<b>Model</b>	<b>Lead designation</b> 12: 12mm 6: 6mm 2: 2mm	<b>Brake</b> No entry: No brakes BK: Brakes provided	<b>Origin position change</b> None: Standard Z: Non-motor side	<b>Grease type</b> None: Standard GC: Clean	<b>Stroke</b> 50 to 400 (50mm pitch)	<b>Cable length<sup>Note 1</sup></b> 3L: 3.5m 5L: 5m 10L: 10m 3K/5K/10K (Flexible cable)
--------------	---	--	--	---	--	---

## TSX

<b>Positioner<sup>Note 3</sup></b> TS-X	<b>Driver: Power-supply voltage / Power capacity</b> 105: 100V/100W or less 205: 200V/100W or less	<b>LCD monitor</b> No entry: None L: With LCD	<b>I/O selection</b> NP: NPN PN: PNP CC: CC-Link DN: DeviceNet™ EP: EtherNet/IP™ PT: PROFINET GW: No I/O board <sup>Note 3</sup>	<b>Battery</b> B: With battery (Absolute) N: None (Incremental)
--	--	---	---	---

## SR1-X

<b>Controller</b>	<b>05</b> Driver: Power capacity 05: 100W or less	<b>Usable for CE</b> No entry: Standard E: CE marking	<b>I/O selection</b> N: NPN P: PNP CC: CC-Link DN: DeviceNet™ PB: PROFIBUS	<b>Battery</b> B: With battery (Absolute) N: None (Incremental)
-------------------	---	---	---	---

## RDV-X

<b>Driver</b>	<b>2</b> Power-supply voltage 2: AC200V	<b>05</b> Driver: Power capacity 05: 100W or less
---------------	---	---

Note 1. The robot cable is standard cable (3L/5L/10L), but can be changed to flexible cable. See P.596 for details on robot cable.

Note 2. See P.500 for DIN rail mounting bracket.

Note 3. Select this selection when using the gateway function. For details, see P.62.

### Specifications

AC servo motor output (W)	30
Repeatability <sup>Note 1</sup> (mm)	+/-0.02
Deceleration mechanism	Ball screw $\phi 8$
Ball screw lead (mm)	12 6 2
Maximum speed (mm/sec)	720 360 120
Maximum payload (kg)	Horizontal 4.5 6 6
	Vertical 1.2 2.4 7.2
Rated thrust (N)	32 64 153
Stroke (mm)	50 to 400 (50mm pitch)
Overall length (mm)	Horizontal Stroke+198
	Vertical Stroke+236
Maximum dimensions of cross section of main unit (mm)	W45 x H53
Cable length (m)	Standard: 3.5 / Option: 5,10
Linear guide type	2 rows of gothic arch grooves x 1 rail
Position detector	Resolvers <sup>Note 2</sup>
Resolution (Pulse/rotation)	16384

Note 1. Positioning repeatability in one direction.

Note 2. Position detectors (resolvers) are common to incremental and absolute specifications. If the controller has a backup function then it will be absolute specifications.

### Allowable overhang<sup>Note</sup>

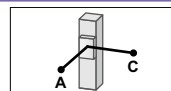
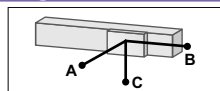
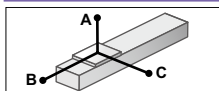

Horizontal installation (Unit: mm)				Wall installation (Unit: mm)				Vertical installation (Unit: mm)		
Lead	Weight	A	B/C	Lead	Weight	A/B/C	Lead	A/C	Weight	MP
Lead 12	2kg	341	90 174	Lead 12	2kg	140 73 300	Lead 12			
	4.5kg	172	37 72		4.5kg	47 22 119				
Lead 6	3kg	355	58 134	Lead 6	3kg	105 42 260	Lead 6			
	6kg	235	27 62		6kg	31 11 135				
Lead 2	3kg	1105	59 142	Lead 2	3kg	113 42 810	Lead 2			
	6kg	520	27 66		6kg	32 11 305				

Note. Distance from center of slider top to center of gravity of object being carried at a guide service life of 10,000 km.

Note. Service life is calculated for 300mm stroke models.

### Static loading moment

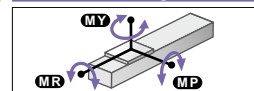

(Unit: N·m)		
MY	MP	MR
15	19	18

### Controller

Controller	Operation method
SR1-X05	Programming / I/O point trace / Remote command / Operation using RS-232C communication
RCX221/222	
RCX240/340	
TS-X105	I/O point trace / Remote command
TS-X205	
RDV-X205	Pulse train control

## T4LH

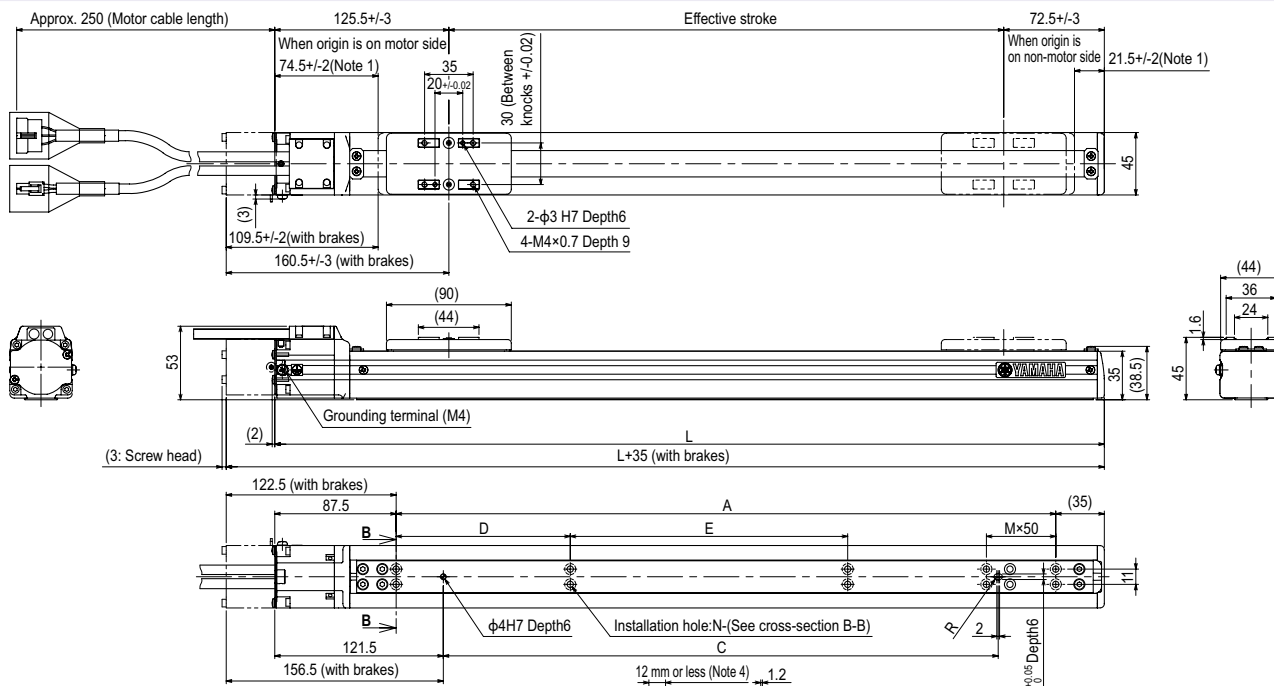

Effective stroke	L	Effective stroke								
		50	100	150	200	250	300	350	400	
A	125.5	175.5	225.5	275.5	325.5	375.5	425.5	475.5		
C	50	100	150	200	250	300	350	400		
D	-	-	-	-	125.5	125.5	125.5	125.5		
E	-	-	-	-	-	-	200	200		
M	0	1	2	3	0	1	0	1		
N	4	6	8	10	6	8	8	10		
Weight (kg) <sup>Note 3</sup>	1.1	1.2	1.4	1.5	1.6	1.7	1.8	1.9		
Maximum speed for each stroke (mm/sec)	Lead 12	720								
	Lead 6	360								
	Lead 2	120								

Note 1. Stop positions are determined by the mechanical stoppers at both ends.  
 Note 2. Minimum bend radius of motor cable is R30.  
 Note 3. Weight of models with no brake. The weight of brake-attached models is 0.2 kg heavier than the models with no brake shown in the table.  
 Note 4. The under-head length of the hex socket-head bolt (M4×0.7) to be used for the installation work is 12mm or less.  
 Note 5. External view of T4LH is identical to T4L.

Articulated robots  
YA  
Linear conveyor modules  
LCM100  
Compact single-axis robots  
TRANSEVO  
Single-axis robots  
FLIP-X  
Linear motor single-axis robots  
PHASER  
Cartesian robots  
XY-X  
SCARA robots  
YK-X  
Pick & place robots  
YP-X  
CLEAN  
CONTROLLER INFORMATION  
T type  
F type  
GF type  
N type  
BR type

# T5L

- High lead: Lead 20
- Origin on the non-motor side is selectable
- Controller: 24V



## Ordering method

<b>T5L</b>							<b>ERCD</b>	
<b>Model</b>	<b>Lead designation</b>	<b>Brake</b> <sup>Note 1</sup>	<b>Origin position change</b>	<b>Grease type</b>	<b>Stroke</b>	<b>Cable length</b> <sup>Note 2</sup>	<b>Controller</b>	<b>I/O connector specification</b>
	20: 20mm 12: 12mm 6: 6mm	No entry: No brakes BK: Brakes provided	None: Standard Z: Non-motor side	None: Standard GC: Clean	50 to 800 (50mm pitch)	1K: 1m 3K: 3.5m 5K: 5m 10K: 10m		CN1: I/O flat cable 1m (Standard) CN2: Twisted-pair cable 2m (pulse train function)

Note 1. The model with a lead of 20mm cannot select specifications with brake (vertical specifications).  
Note 2. The robot cable is flexible and resists bending. See P.596 for details on robot cable.

## Specifications

<b>AC servo motor output (W)</b>	30
<b>Repeatability</b> <sup>Note 1</sup> (mm)	+/-0.02
<b>Deceleration mechanism</b>	Ball screw $\phi 12$
<b>Ball screw lead (mm)</b>	20 12 6
<b>Maximum speed</b> <sup>Note 2</sup> (mm/sec)	1200 800 400
<b>Maximum payload (kg)</b>	Horizontal 3 5 9 Vertical - 1.2 2.4
<b>Rated thrust (N)</b>	19 32 64
<b>Stroke (mm)</b>	50 to 800 (50mm pitch)
<b>Overall length (mm)</b>	Horizontal Stroke+201.5 Vertical Stroke+239.5
<b>Maximum dimensions of cross section of main unit (mm)</b>	W55×H52
<b>Cable length (m)</b>	Standard: 3.5 / Option: 1.5, 10
<b>Linear guide type</b>	2 rows of gothic arch grooves × 1 rail
<b>Position detector</b>	Resolvers <sup>Note 3</sup>
<b>Resolution (Pulse/rotation)</b>	16384

Note 1. Positioning repeatability in one direction.  
Note 2. When the stroke is longer than 600mm, resonance of the ball screw may occur depending on the operation conditions (critical speed). In this case, reduce the speed setting on the program by referring to the maximum speeds shown in the table below.  
Note 3. Position detectors (resolvers) are common to incremental and absolute specifications. If the controller has a backup function then it will be absolute specifications.

## Allowable overhang<sup>Note</sup>

	Horizontal installation (Unit: mm)			Wall installation (Unit: mm)			Vertical installation (Unit: mm)		
	A	B	C	A	B	C	A	C	
<b>Lead 20</b>	1kg 600	323	683	1kg 600	291	600	1.2kg 242	240	
<b>Lead 12</b>	3kg 675	103	247	3kg 215	73	589	2.4kg 113	113	
<b>Lead 6</b>	2kg 1170	159	406	2kg 368	127	1082			
	5kg 555	59	155	5kg 127	30	449			
	3kg 1498	104	294	3kg 263	73	970			
	9kg 628	31	89	9kg 54	0	400			

Note. Distance from center of slider top to center of gravity of object being carried at a guide service life of 10,000 km.  
Note. Service life is calculated for 600mm stroke models.

## Static loading moment

(Unit: N·m)		
MY	MP	MR
30	34	40

## Controller

Controller	Operation method
ERCD	Pulse train control / Programming / I/O point trace / Remote command / Operation using RS-232C communication

## T5L

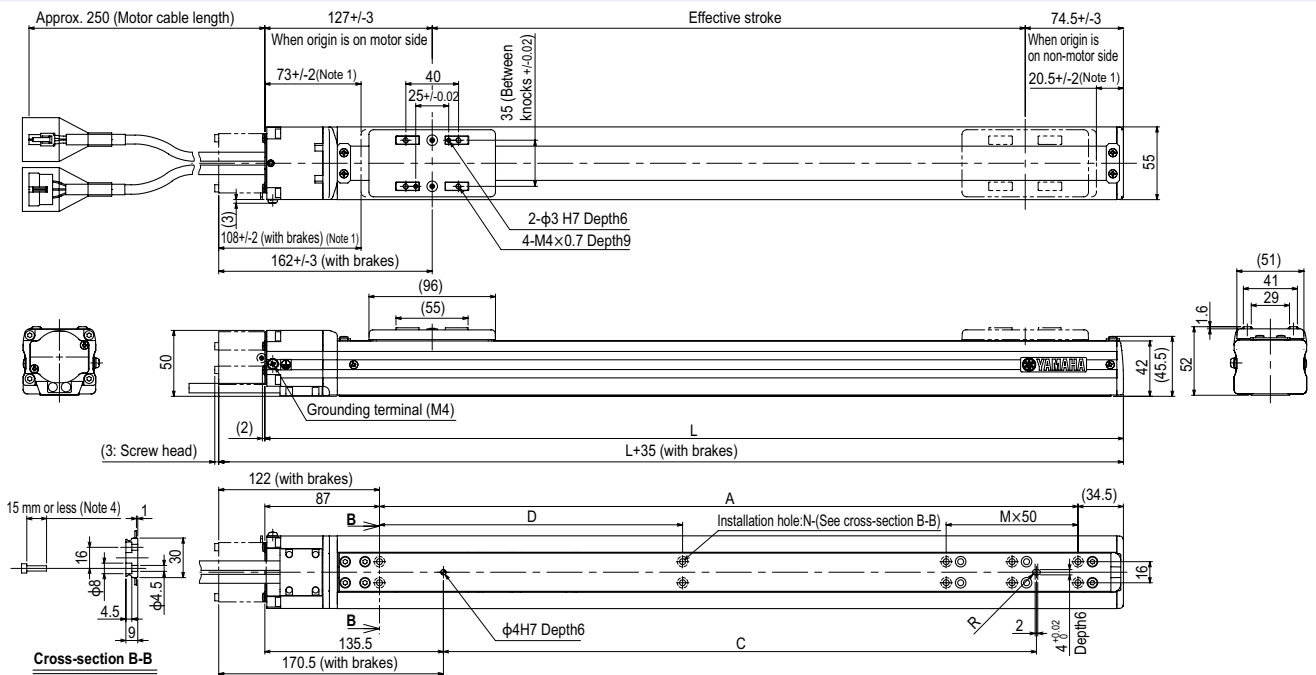

Effective stroke	50	100	150	200	250	300	350	400	450	500	550	600	650	700	750	800
L	251.5	301.5	351.5	401.5	451.5	501.5	551.5	601.5	651.5	701.5	751.5	801.5	851.5	901.5	951.5	1001.5
A	130	180	230	280	330	380	430	480	530	580	630	680	730	780	830	880
C	50	100	150	200	250	300	350	400	450	500	550	600	650	700	750	800
D	-	-	-	-	-	230	230	230	230	230	230	230	230	230	230	230
M	0	1	2	3	4	5	0	1	2	3	4	5	6	7	8	9
N	4	6	8	10	12	14	6	8	10	12	14	16	18	20	22	24
<b>Weight (kg)</b> <sup>Note 3</sup>	1.7	1.8	2.0	2.2	2.3	2.5	2.7	2.8	3.0	3.2	3.3	3.5	3.7	3.8	4.0	4.2
<b>Maximum speed for each stroke</b> <sup>Note 5</sup> (mm/sec)												960	840	720	660	
<b>Speed setting</b>												80%	70%	60%	55%	

Note 1. Stop positions are determined by the mechanical stoppers at both ends.  
Note 2. Minimum bend radius of motor cable is R30.  
Note 3. Weight of models with no brake. The weight of brake-attached models is 0.2 kg heavier than the models with no brake shown in the table.  
Note 4. The under-head length of the hex socket-head bolt (M4×0.7) to be used for the installation work is 15mm or less.  
Note 5. When the stroke is longer than 600mm, resonance of the ball screw may occur depending on the operation conditions (critical speed). In this case, reduce the speed setting on the program by referring to the maximum speeds shown in the table at the left.  
Note 6. External view of T5LH is identical to T5L.



# T5LH

- High lead: Lead 20
- Origin on the non-motor side is selectable
- Controller: 100V / 200V



## Ordering method

<b>T5LH</b>	<b>Model</b>	<b>Lead designation</b> 20: 20mm 12: 12mm 6: 6mm	<b>Brake</b> <sup>Note 1</sup> No entry: No brakes BK: Brakes provided	<b>Origin position change</b> None: Standard Z: Non-motor side	<b>Grease type</b> None: Standard GC: Clean	<b>Stroke</b> 50 to 800 (50mm pitch)	<b>Cable length</b> <sup>Note 2</sup> 3L: 3.5m 5L: 5m 10L: 10m 3K/5K/10K (Flexible cable)	<b>TSX</b>	<b>Positioner</b> <sup>Note 3</sup> TS-X	<b>Driver: Power-supply voltage / Power capacity</b> 105: 100V/100W or less 205: 200V/100W or less	<b>LCD monitor</b> No entry: None L: With LCD	<b>I/O selection</b> NP: NPN PN: PNP CC: CC-Link DN: DeviceNet™ EP: EtherNet/IP™ PT: PROFINET GW: No I/O board <sup>Note 4</sup>	<b>Battery</b> B: With battery (Absolute) N: None (Incremental)	
								<b>SR1-X</b>	<b>Controller</b>	<b>05</b>	<b>Driver: Power capacity</b> 05: 100W or less	<b>Usable for CE</b> No entry: Standard E: CE marking	<b>I/O selection</b> N: NPN P: PNP CC: CC-Link DN: DeviceNet™ PB: PROFIBUS	<b>Battery</b> B: With battery (Absolute) N: None (Incremental)
								<b>RDV-X</b>	<b>Driver</b>	<b>2</b>	<b>Power-supply voltage</b> 2: AC200V		<b>05</b>	<b>Driver: Power capacity</b> 05: 100W or less

- Note 1. The model with a lead of 20mm cannot select specifications with brake (vertical specifications).  
 Note 2. The robot cable is standard cable (3L/5L/10L), but can be changed to flexible cable. See P.596 for details on robot cable.  
 Note 3. See P.500 for DIN rail mounting bracket.  
 Note 4. Select this selection when using the gateway function. For details, see P.62

## Specifications

<b>AC servo motor output (W)</b>	30
<b>Repeatability</b> <sup>Note 1</sup> (mm)	+/-0.02
<b>Deceleration mechanism</b>	Ball screw $\phi$ 12
<b>Ball screw lead (mm)</b>	20 12 6
<b>Maximum speed</b> <sup>Note 2</sup> (mm/sec)	1200 800 400
<b>Maximum payload</b> (kg)	<b>Horizontal</b> 3 5 9 <b>Vertical</b> - 1.2 2.4
<b>Rated thrust (N)</b>	19 32 64
<b>Stroke (mm)</b>	50 to 800 (50mm pitch)
<b>Overall length (mm)</b>	<b>Horizontal</b> Stroke+201.5 <b>Vertical</b> Stroke+239.5
<b>Maximum dimensions of cross section of main unit (mm)</b>	W55×H52
<b>Cable length (m)</b>	Standard: 3.5 / Option: 5,10
<b>Linear guide type</b>	2 rows of gothic arch grooves × 1 rail
<b>Position detector</b>	Resolvers <sup>Note 3</sup>
<b>Resolution (Pulse/rotation)</b>	16384

- Note 1. Positioning repeatability in one direction.  
 Note 2. When the stroke is longer than 600mm, resonance of the ball screw may occur depending on the operation conditions (critical speed). In this case, reduce the speed setting on the program by referring to the maximum speeds shown in the table below.  
 Note 3. Position detectors (resolvers) are common to incremental and absolute specifications. If the controller has a backup function then it will be absolute specifications.

## Allowable overhang

	Horizontal installation (Unit: mm)				Wall installation (Unit: mm)				Vertical installation (Unit: mm)		
	A	B	C	Stroke	A	B	C	Stroke	Lead 12	A	C
<b>Lead 20</b>	967	324	598	50	551	304	925	50	1.2kg	240	239
<b>Lead 12</b>	429	104	226	50	185	89	378	50	2.4kg	109	110
<b>Lead 6</b>	916	159	398	50	347	141	800	50			
<b>Lead 12</b>	436	60	152	50	119	44	355	50			
<b>Lead 6</b>	1194	105	294	50	259	87	950	50			
<b>Lead 9k</b>	624	31	89	50	50	15	385	50			

Note. Distance from center of slider top to center of gravity of object being carried at a guide service life of 10,000 km.  
 Note. Service life is calculated for 600mm stroke models.

## Static loading moment

(Unit: N·m)		
MY	MP	MR
30	34	40

## Controller

Controller	Operation method
SR1-X05	Programming / I/O point trace / Remote command / Operation using RS-232C communication
RCX221/222	
RCX240/340	
TS-X105	I/O point trace / Remote command
TS-X205	
RDV-X205	Pulse train control

## T5LH

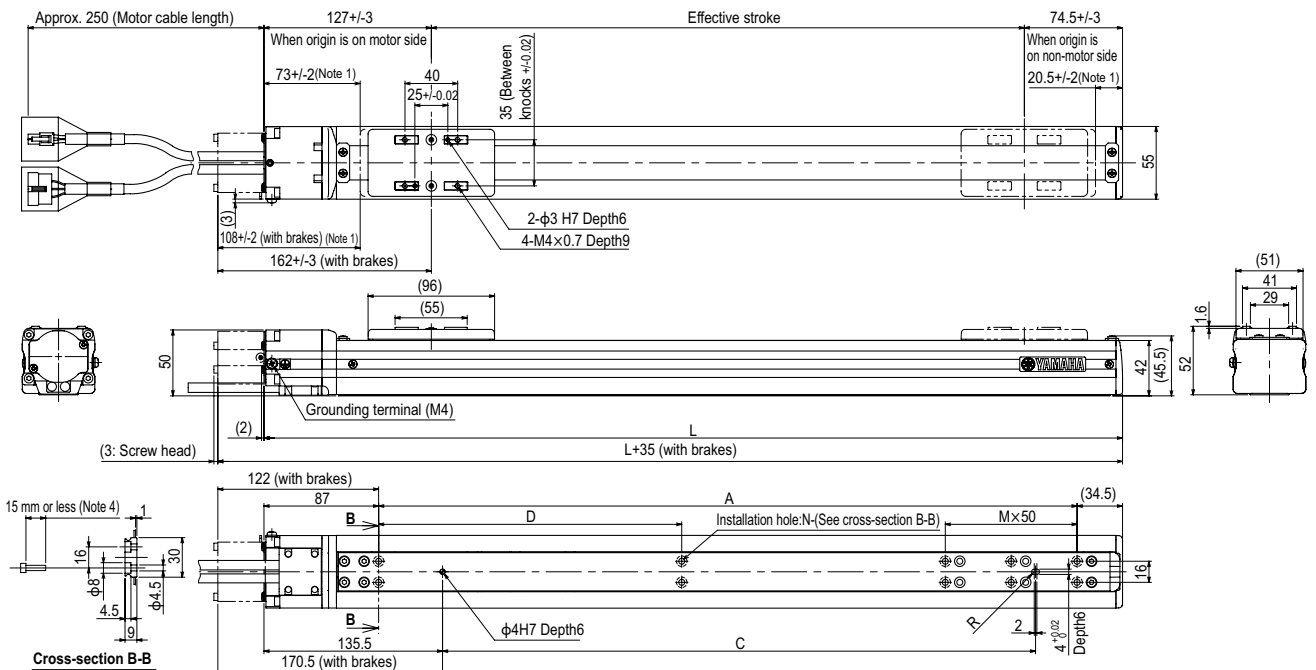

Effective stroke	50	100	150	200	250	300	350	400	450	500	550	600	650	700	750	800
<b>L</b>	251	530	535	540	545	551	556	561	565	570	575	580	585	590	595	600
<b>A</b>	130	180	230	280	330	380	430	480	530	580	630	680	730	780	830	880
<b>C</b>	50	100	150	200	250	300	350	400	450	500	550	600	650	700	750	800
<b>D</b>	-	-	-	-	-	230	230	230	230	230	230	230	230	230	230	230
<b>M</b>	0	1	2	3	4	5	0	1	2	3	4	5	6	7	8	9
<b>N</b>	4	6	8	10	12	14	6	8	10	12	14	16	18	20	22	24
<b>Weight (kg)</b> <sup>Note 3</sup>	1.7	1.8	2.0	2.2	2.3	2.5	2.7	2.8	3.0	3.2	3.3	3.5	3.7	3.8	4.0	4.2
<b>Maximum speed for each stroke</b> <sup>Note 5</sup> (mm/sec)	-															
<b>Speed setting</b>	-															

- Note 1. Stop positions are determined by the mechanical stoppers at both ends.  
 Note 2. Minimum bend radius of motor cable is R30.  
 Note 3. Weight of models with no brake. The weight of brake-attached models is 0.2 kg heavier than the models with no brake shown in the table.  
 Note 4. The under-head length of the hex socket-head bolt (M4×0.7) to be used for the installation work is 15mm or less.  
 Note 5. When the stroke is longer than 600mm, resonance of the ball screw may occur depending on the operation conditions (critical speed). In this case, reduce the speed setting on the program by referring to the maximum speeds shown in the table at the left.  
 Note 6. External view of T5LH is identical to T5L.

# T6L

- High lead: Lead 20
- Origin on the non-motor side is selectable
- Controller: 100V / 200V



## Ordering method

<b>T6L</b>	<b>Model</b>	<b>Lead designation</b> 20: 20mm 12: 12mm 6: 6mm	<b>Brake</b> <sup>Note 1</sup> No entry: No brakes BK: Brakes provided	<b>Origin position change</b> None: Standard Z: Non-motor side	<b>Grease type</b> None: Standard GC: Clean	<b>Stroke</b> 50 to 800 (50mm pitch)	<b>Cable length</b> <sup>Note 3</sup> 3L: 3.5m 5L: 5m 10L: 10m 5K/5K/10K (Flexible cable)	<b>TSX</b>	<b>Positioner</b> <sup>Note 3</sup> TS-X	<b>Driver: Power-supply voltage / Power capacity</b> 105: 100V/100W or less 205: 200V/100W or less	<b>LCD monitor</b> No entry: None L: With LCD	<b>I/O selection</b> NP: NPN PN: PNP CC: CC-Link DN: DeviceNet™ EP: EtherNet/IP™ PT: PROFINET GW: No I/O board <sup>Note 4</sup>	<b>Battery</b> B: With battery (Absolute) N: None (Incremental)			
								<b>SR1-X</b>	<b>Controller</b>	<b>05</b>	<b>Driver: Power capacity</b> 05: 100W or less	<b>Usable for CE</b> No entry: Standard E: CE marking	<b>I/O selection</b> N: NPN P: PNP CC: CC-Link DN: DeviceNet™ PB: PROFIBUS	<b>Battery</b> B: With battery (Absolute) N: None (Incremental)		
								<b>RDV-X</b>	<b>Driver</b>	<b>2</b>	<b>Power-supply voltage</b> 2: AC200V		<b>05</b>	<b>Driver: Power capacity</b> 05: 100W or less	<b>RBR1</b>	<b>Regenerative unit</b>

Note 1. The model with a lead of 20mm cannot select specifications with brake (vertical specifications).  
 Note 2. The robot cable is standard cable (3L/5L/10L), but can be changed to flexible cable. See P.596 for details on robot cable.  
 Note 3. See P.500 for DIN rail mounting bracket.  
 Note 4. Select this selection when using the gateway function. For details, see P.62.

## Specifications

<b>AC servo motor output (W)</b>	60		
<b>Repeatability</b> <sup>Note 1</sup> (mm)	+/-0.02		
<b>Deceleration mechanism</b>	Ball screw $\phi 12$		
<b>Ball screw lead (mm)</b>	20	12	6
<b>Maximum speed</b> <sup>Note 2</sup> (mm/sec)	1333	800	400
<b>Maximum payload (kg)</b>	<b>Horizontal</b>	<b>Vertical</b>	
	10	12	30
	-	4	8
<b>Rated thrust (N)</b>	51	85	170
<b>Stroke (mm)</b>	50 to 800 (50mm pitch)		
<b>Overall length (mm)</b>	<b>Horizontal</b>	<b>Vertical</b>	
	Stroke+247.5	Stroke+285.5	
<b>Maximum dimensions of cross section of main unit (mm)</b>	W65×H56		
<b>Cable length (m)</b>	Standard: 3.5 / Option: 5,10		
<b>Linear guide type</b>	2 rows of gothic arch grooves × 1 rail		
<b>Position detector</b>	Resolvers <sup>Note 3</sup>		
<b>Resolution (Pulse/rotation)</b>	16384		

Note 1. Positioning repeatability in one direction.  
 Note 2. When the stroke is longer than 600mm, resonance of the ball screw may occur depending on the operation conditions (critical speed). In this case, reduce the speed setting on the program by referring to the maximum speeds shown in the table below.  
 Note 3. Position detectors (resolvers) are common to incremental and absolute specifications. If the controller has a backup function then it will be absolute specifications.

## Allowable overhang

Installation	Lead	Horizontal installation (Unit: mm)			Wall installation (Unit: mm)			Vertical installation (Unit: mm)				
		A	B	C	A	B	C	A	B	C		
Horizontal	20	2kg	319	184	234	2kg	234	152	265	1kg	355	352
	6	6kg	98	37	77	6kg	61	13	71	2kg	165	165
	12	10kg	64	0	55	10kg	30	0	42	4kg	70	72
Wall	20	3kg	624	125	335	3kg	293	96	510	2kg	171	172
	6	8kg	273	41	121	8kg	89	14	210	4kg	73	74
	12	12kg	216	24	77	12kg	43	0	130	8kg	23	26
Vertical	6	5kg	694	73	236	5kg	204	45	530			
	12	10kg	374	33	109	10kg	72	0	245			
	20	30kg	159	0	25	30kg	0	0	0			

Note. Distance from center of slider top to center of gravity of object being carried at a guide service life of 10,000 km.  
 Note. Service life is calculated for 600mm stroke models.

## Static loading moment

Direction	Value (Unit: N·m)
MY	35
MP	40
MR	50

## Controller

Controller	Operation method
SR1-X05	Programming / I/O point trace / Remote command / Operation using RS-232C communication
RCX221/222	
RCX240/340	
TS-X105	I/O point trace / Remote command
TS-X205	
RDV-X205-RBR1	Pulse train control

## T6L

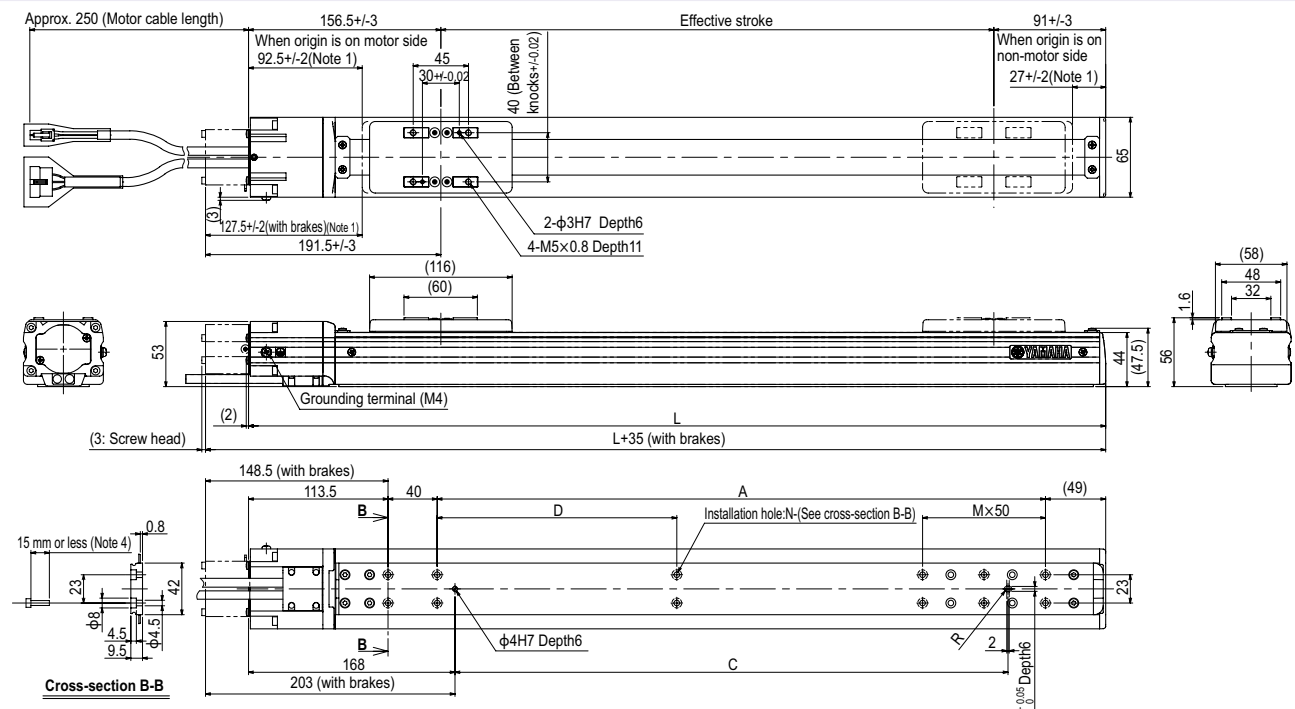

Effective stroke	Stroke (mm)															
	50	100	150	200	250	300	350	400	450	500	550	600	650	700	750	800
L	297.5	347.5	397.5	447.5	497.5	547.5	597.5	647.5	697.5	747.5	797.5	847.5	897.5	947.5	997.5	1047.5
A	95	145	195	245	295	345	395	445	495	545	595	645	695	745	795	845
C	50	100	150	200	250	300	350	400	450	500	550	600	650	700	750	800
D	-	-	-	-	-	-	195	195	195	195	195	195	195	195	195	195
M	0	1	2	3	4	5	0	1	2	3	4	5	6	7	8	9
N	6	8	10	12	14	16	8	10	12	14	16	18	20	22	24	26
Weight (kg) <sup>Note 3</sup>	2.4	2.6	2.8	3.1	3.3	3.5	3.7	4.0	4.2	4.4	4.6	4.8	5.1	5.3	5.5	5.7
Maximum speed for each stroke <sup>Note 5</sup> (mm/sec)	Lead 20	1333														
	Lead 12	800														
	Lead 6	400														
	Speed setting	85% 75% 65% 60%														

Note 1. Stop positions are determined by the mechanical stoppers at both ends.  
 Note 2. Minimum bend radius of motor cable is R30.  
 Note 3. Weight of models with no brake. The weight of brake-attached models is 0.2 kg heavier than the models with no brake shown in the table.  
 Note 4. The under-head length of the hex socket-head bolt (M4x0.7) to be used for the installation work is 15mm or less.  
 Note 5. When the stroke is longer than 600mm, resonance of the ball screw may occur depending on the operation conditions (critical speed). In this case, reduce the speed setting on the program by referring to the maximum speeds shown in the table at the left.

# T9

● High lead: Lead 30

● Origin on the non-motor side is selectable: Lead 10-20-30

Note. Strokes longer than 1050mm are special order items. Please consult us for delivery time.



## Ordering method

**T9**

Model	Lead designation	Brake	Origin position change	Grease type	Stroke	Cable length
	30: 30mm 20: 20mm 10: 10mm 5: 5mm	No entry/No brakes BK: Brakes provided	None: Standard Z: Non-motor side	None: Standard GC: Clean	Lead 20-10-5: 150 to 1050 (50mm pitch) Lead 30: 150 to 1250 (50mm pitch)	3L: 3.5m 5L: 5m 10L: 10m 3K/5K/10K (Flexible cable)

**TSX**

Positioner	Driver: Power-supply voltage	Regenerative unit	LCD monitor	I/O selection	Battery
TS-X	105: 100V/100W or less 205: 200V/100W or less	No entry: None R: With RGT	No entry: None L: With LCD	NP: NPN PN: PNP CC: CC-Link DN: DeviceNet™ EP: EtherNet/IP™ PT: PROFINET GW: No I/O board	B: With battery (Absolute) N: None (Incremental)

**SR1-X 05**

Controller	Driver: Power capacity	Usable for CE	Regenerative unit	I/O selection	Battery
SR1-X 05	100W or less	No entry: Standard E: CE marking	No entry: None R: With RG1	N: NPN P: PNP CC: CC-Link DN: DeviceNet™ PB: PROFIBUS	B: With battery (Absolute) N: None (Incremental)

**RDV-X 2 05 RBR1**

Driver	Power-supply voltage	Driver: Power capacity	Regenerative unit
RDV-X 2	AC200V	05: 100W or less	RBR1

- Note 1. The model with a lead of 30mm cannot select specifications with brake (vertical specifications).  
 Note 2. If selecting 5mm lead specifications then the origin point cannot be changed to the non-motor side.  
 Note 3. The robot cable is standard cable (3L/5L/10L), but can be changed to flexible cable. See P.596 for details on robot cable.  
 Note 4. See P.500 for DIN rail mounting bracket.  
 Note 5. Select this selection when using the gateway function. For details, see P.62.

## Specifications

AC servo motor output (W)	100
Repeatability (mm)	+/-0.01
Deceleration mechanism	Ball screw
Ball screw lead (mm)	30 20 10 5
Maximum speed (mm/sec)	1800 1200 600 300
Maximum payload (kg)	Horizontal: 15 30 55 80 Vertical: - 4 10 20
Rated thrust (N)	56 84 169 339
Stroke (mm)	150 to 1250 (50mm pitch)
Overall length (mm)	Horizontal: Stroke+259 Vertical: Stroke+289
Maximum dimensions of cross section of main unit (mm)	W94 x H98
Cable length (m)	Standard: 3.5 / Option: 5.10
Linear guide type	4 rows of circular arc grooves x 1 rail
Position detector	Resolvers
Resolution (Pulse/rotation)	16384

- Note 1. Positioning repeatability in one direction.  
 Note 2. When the stroke is longer than 700mm, resonance of the ball screw may occur depending on the operation conditions (critical speed). In this case, reduce the speed setting on the program by referring to the maximum speeds shown in the table below.  
 Note 3. Strokes longer than 1050mm are available only for high lead (Lead 30). (Special order item)  
 Note 4. Position detectors (resolvers) are common to incremental and absolute specifications. If the controller has a backup function then it will be absolute specifications.

## Allowable overhang

Lead	Horizontal installation (Unit: mm)			Wall installation (Unit: mm)			Vertical installation (Unit: mm)		
	A	B	C	A	B	C	A	C	
Lead 30	5kg: 864	501	383	5kg: 348	384	776	1kg: 600	600	
Lead 20	15kg: 491	156	140	15kg: 87	40	306	2kg: 1098	1098	
Lead 10	5kg: 1292	505	462	5kg: 416	388	1186	4kg: 545	545	
Lead 5	15kg: 572	158	151	15kg: 92	42	386	10kg: 594	594	
	30kg: 455	73	75	30kg: 0	0	61	8kg: 280	280	
	20kg: 617	119	127	10kg: 193	132	910	10kg: 217	217	
	40kg: 422	53	59	20kg: 53	0	400	10kg: 221	221	
	55kg: 420	36	40	30kg: 0	0	109	15kg: 135	135	
	50kg: 722	42	47	10kg: 197	133	2360	20kg: 92	92	
	60kg: 657	33	37	20kg: 54	0	985			
	80kg: 577	23	25	30kg: 0	0	427			

Note. Distance from center of slider top to center of gravity of object being carried at a guide service life of 10,000 km.

## Static loading moment

(Unit: N·m)		
MY	MP	MR
86	133	117

## Controller

Controller	Operation method
SR1-X05 Note	Programming / I/O point trace / Remote command / Operation using RS-232C communication
RX221/222 Note	I/O point trace / Remote command
RX240/340 Note	Pulse train control
TS-X105 Note	I/O point trace / Remote command
TS-X205 Note	Remote command
RDV-X205-RBR1	

Note. Regenerative unit is required when the models used vertically with 700mm or larger stroke.

## T9

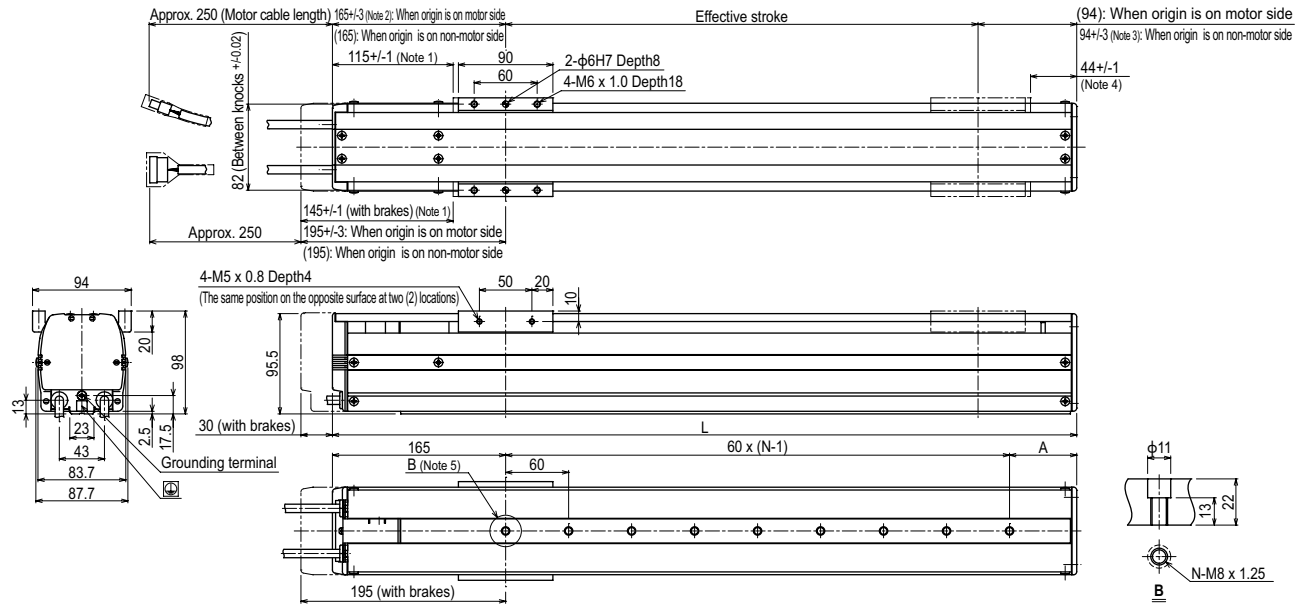

- Note 1. Stop positions are determined by the mechanical stoppers at both ends.  
 Note 2. 167.5±1 when the high lead specification (Lead 30) is used.  
 Note 3. 94±1 when the high lead specification (Lead 30) is used.  
 Note 4. 41.5±1 when the high lead specification (Lead 30) is used.  
 Note 5. When installing the unit, washers, etc., cannot be used in the φ11 counter bore hole.  
 Note 6. Minimum bend radius of motor cable is R5.  
 Note 7. Weight of models with no brake. The weight of brake-attached models is 0.5 kg heavier than the models with no brake shown in the table.

Effective stroke	150	200	250	300	350	400	450	500	550	600	650	700	750	800	850	900	950	1000	1050	1100	1150	1200	1250
	L	409	459	509	559	609	659	709	759	809	859	909	959	1009	1059	1109	1159	1209	1259	1309	1359	1409	1459
A	64	54	44	94	84	74	64	54	44	94	84	74	64	54	44	94	84	74	64	54	44	94	84
N	4	5	6	6	7	8	9	10	11	11	12	13	14	15	16	16	17	18	19	20	21	21	22
Weight (kg)	5.5	5.9	6.2	6.6	6.9	7.3	7.6	8.0	8.3	8.7	9.0	9.4	9.7	10.0	10.3	10.7	11.0	11.4	11.7	12.1	12.5	12.9	13.3
Maximum speed (mm/sec)	Lead 30	1800																					
	Lead 20	1200																					
	Lead 10	600																					
	Lead 5	300																					
Speed setting	80%																						

- Note 8. When the stroke is longer than 700mm, resonance of the ball screw may occur depending on the operation conditions (critical speed). In this case, reduce the speed setting on the program by referring to the maximum speeds shown in the table above.  
 Note 9. Strokes longer than 1050mm are special order items. Please contact us for speed setting.

# T9H

● High lead: Lead 30

● Origin on the non-motor side is selectable: Lead 20-30

Note. Strokes longer than 1050mm are special order items. Please consult us for delivery time.



## Ordering method

T9H					
Model	Lead designation	Brake	Origin position change	Grease type	Stroke
	30: 30mm 20: 20mm 10: 10mm 5: 5mm	No entry/No brakes BK: Brakes provided	None: Standard Z: Non-motor side	None: Standard GC: Clean	Lead 20/10/5: 150 to 1050 (50mm pitch) Lead 30: 150 to 1250 (50mm pitch)
					Cable length
					3L: 3.5m 5L: 5m 10L: 10m 3K/5K/10K (Flexible cable)

TSX				
Positioner	Driver: Power-supply voltage Power capacity	Regenerative unit	LCD monitor	I/O selection
TS-X	110: 100V/200W 210: 200V/200W	No entry: None R: With RGT	No entry: None L: With LCD	NP: NPN PN: PNP CC: CC-Link DN: DeviceNet™ EP: EtherNet/IP™ PT: PROFINET GW: No I/O board
				Battery
				B: With battery (Absolute) N: None (Incremental)
SR1-X 10				
Controller	Driver: Power capacity	Usable for CE	Regenerative unit	I/O selection
	10: 200W	No entry: Standard E: CE marking	No entry: None R: With RGT	N: NPN P: PNP CC: CC-Link DN: DeviceNet™ PB: PROFIBUS
				Battery
				B: With battery (Absolute) N: None (Incremental)
RDV-X 2		10		RBR1
Driver	Power-supply voltage	Driver: Power capacity	Regenerative unit	
	2: AC200V	10: 200W or less		

- Note 1. The model with a lead of 30mm cannot select specifications with brake (vertical specifications).
- Note 2. If selecting 10mm-5mm lead specifications then the origin point cannot be changed to the non-motor side.
- Note 3. The robot cable is standard cable (3L/5L/10L), but can be changed to flexible cable. See P.596 for details on robot cable.
- Note 4. See P.500 for DIN rail mounting bracket.
- Note 5. Select this selection when using the gateway function. For details, see P.62.

## Specifications

AC servo motor output (W)	200		
Repeatability (mm)	±0.01		
Deceleration mechanism	Ball screw		
Ball screw lead (mm)	30	20	10
Maximum speed (mm/sec)	1800	1200	600
Maximum payload (kg)	Horizontal: 25	40	80
Rated thrust (N)	113	170	341
Stroke (mm)	150 to 1250 (50mm pitch)		
Overall length (mm)	Stroke+273		
Maximum dimensions of cross section of main unit (mm)	W94 × H98		
Cable length (m)	Standard: 3.5 / Option: 5.10		
Linear guide type	4 rows of circular arc grooves × 1 rail		
Position detector	Resolvers		
Resolution (Pulse/rotation)	16384		

- Note 1. Positioning repeatability in one direction.
- Note 2. When the stroke is longer than 700mm, resonance of the ball screw may occur depending on the operation conditions (critical speed). In this case, reduce the speed setting on the program by referring to the maximum speeds shown in the table below.
- Note 3. Strokes longer than 1050mm are available only for high lead (Lead 30). (Special order item)
- Note 4. Position detectors (resolvers) are common to incremental and absolute specifications. If the controller has a backup function then it will be absolute specifications.

## Allowable overhang

Installation	Horizontal installation (Unit: mm)			Wall installation (Unit: mm)			Vertical installation (Unit: mm)		
	A	B	C	A	B	C	A	B	C
Lead 30	10kg: 415	286	183	10kg: 140	120	323	4kg: 515	515	515
Lead 20	10kg: 270	105	93	10kg: 41	0	123	6kg: 334	334	334
Lead 10	10kg: 667	244	225	10kg: 170	128	549	8kg: 244	244	244
Lead 5	10kg: 330	112	107	10kg: 46	0	182	10kg: 217	217	217
	40kg: 162	42	47	40kg: 0	0	0	15kg: 133	133	133
	30kg: 392	75	81	20kg: 52	0	335	20kg: 90	90	90
	50kg: 297	40	44	25kg: 24	0	235	15kg: 135	135	135
	80kg: 265	21	24	30kg: 0	0	108	20kg: 92	92	92
	60kg: 477	22	37	20kg: 54	0	710	20kg: 92	92	92
	80kg: 412	22	25	25kg: 25	0	505	30kg: 49	49	49
	100kg: 362	16	18	30kg: 0	0	355			

Note. Distance from center of slider top to center of gravity of object being carried at a guide service life of 10,000 km.

## Static loading moment

(Unit: N·m)		
MY	MP	MR
86	133	117

## Controller

Controller	Operation method
SR1-X10 Note RCX221/222 RCX240/340	Programming / I/O point trace / Remote command / Operation using RS-232C communication
TS-X110 Note TS-X210 Note RDV-X210-RBR1	I/O point trace / Remote command / Pulse train control

Note. When using the unit vertically, a regeneration unit is required.

## T9H

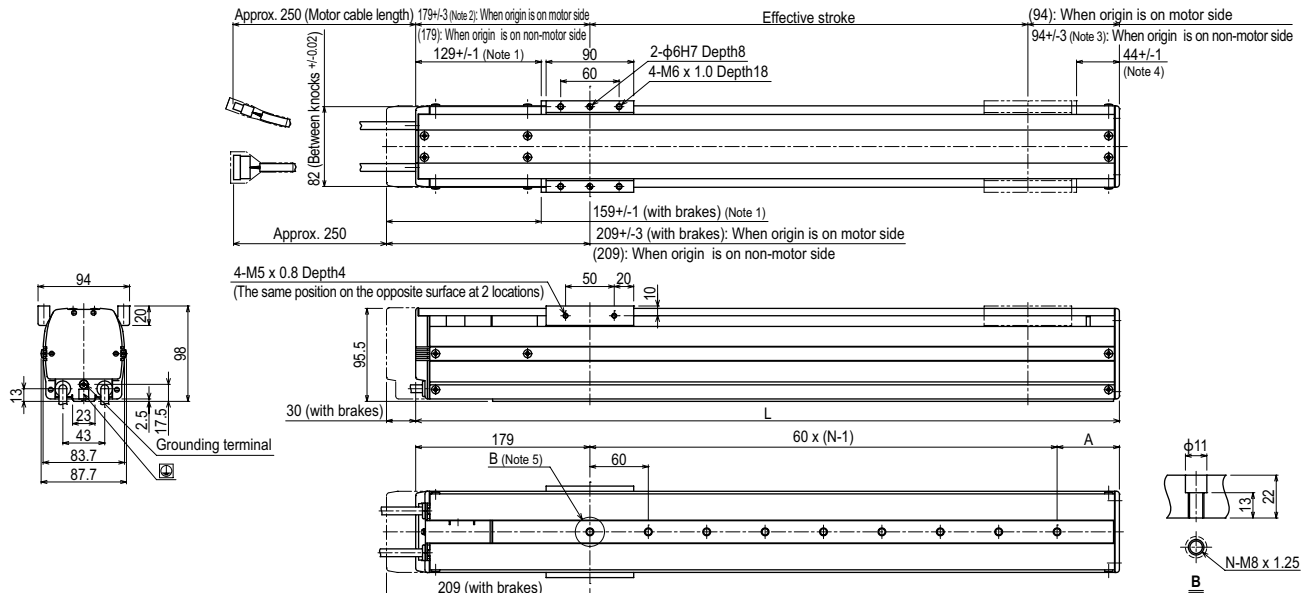

- Note 1. Stop positions are determined by the mechanical stoppers at both ends.
- Note 2. 181.5+/-4 when the high lead specification (Lead 30) is used.
- Note 3. 94+/-4 when the high lead specification (Lead 30) is used.
- Note 4. 41.5+/-1 when the high lead specification (Lead 30) is used.
- Note 5. When installing the unit, washers, etc., cannot be used in the φ11 counter bore hole.
- Note 6. Minimum bend radius of motor cable is R5.
- Note 7. Weight of models with no brake. The weight of brake-attached models is 0.5 kg heavier than the models with no brake shown in the table.

Effective stroke	150	200	250	300	350	400	450	500	550	600	650	700	750	800	850	900	950	1000	1050	1100 <sup>Note 9</sup>	1150 <sup>Note 9</sup>	1200 <sup>Note 9</sup>	1250 <sup>Note 9</sup>
L	423	473	523	573	623	673	723	773	823	873	923	973	1023	1073	1123	1173	1223	1273	1323	1373	1423	1473	1523
A	64	54	44	94	84	74	64	54	44	94	84	74	64	54	44	94	84	74	64	54	44	94	84
N	4	5	6	6	7	8	9	10	11	11	12	13	14	15	16	16	17	18	19	20	21	21	22
Weight (kg) <sup>Note 7</sup>	5.8	6.2	6.5	6.9	7.3	7.7	8.0	8.4	8.8	9.1	9.5	9.9	10.2	10.6	11.0	11.4	11.7	12.1	12.5	12.9	13.3	13.7	14.1
Maximum speed (mm/sec) <sup>Note 8</sup>	Lead 30	1800															1440	1170	900	810			
	Lead 20	1200															960	780	600	540			
	Lead 10	600															480	390	300	270			
	Lead 5	300															240	195	150	135			
Speed setting	-															80%	65%	50%	45%				

- Note 8. When the stroke is longer than 700mm, resonance of the ball screw may occur depending on the operation conditions (critical speed). In this case, reduce the speed setting on the program by referring to the maximum speeds shown in the table above.
- Note 9. Strokes longer than 1050mm are special order items. Please contact us for speed setting.

# F8

● High lead: Lead 20

● Origin on the non-motor side is selectable



## Ordering method

**F8** Model: [ ] Lead designation: 20: 20mm, 12: 12mm, 6: 6mm

**Brake** Note 1: No entry: No brakes, BK: Brakes provided

**Origin position change** Note 2: None: Standard, Z: Non-motor side

**Grease type** Note 3: None: Standard, GC: Clean

**Stroke** 150 to 800 (50mm pitch)

**Cable length** Note 4: 3L: 3.5m, 5L: 5m, 10L: 10m, 3K/5K/10K (Flexible cable)

**TSX** Positioner: TS-X Driver: Power supply voltage / Power capacity: 105: 100V/100W or less, 205: 200V/100W or less LCD monitor: L: With LCD

**I/O selection** NP: NPN, PN: PNP, CC: CC-Link, DN: DeviceNet™, EP: EtherNet/IP™, FT: PROFINET, GW: No I/O board

**Battery** B: With battery (Absolute), N: None (Incremental)

**SR1-X** Controller: 05 Driver: Power capacity: 05: 100W or less Usable for CE: No entry: Standard, E: CE marking

**I/O selection** N: NPN, P: PNP, CC: CC-Link, DN: DeviceNet™, PB: PROFIBUS

**Battery** B: With battery (Absolute), N: None (Incremental)

**RDV-X** Driver: 2 Power supply voltage: 2: AC200V

**05** Driver: Power capacity: 05: 100W or less

**RBR1** Regenerative unit

## Specifications

AC servo motor output (W)	100
Repeatability (mm)	+/-0.02
Deceleration mechanism	Ball screw
Ball screw lead (mm)	20 12 6
Maximum speed (mm/sec)	1200 720 360
Maximum payload (kg)	Horizontal: 12 20 40, Vertical: - 4 8
Rated thrust (N)	84 141 283
Stroke (mm)	150 to 800 (50mm pitch)
Overall length (mm)	Horizontal: Stroke+286, Vertical: Stroke+316
Maximum dimensions of cross section of main unit (mm)	W80 x H65
Cable length (m)	Standard: 3.5 / Option: 5.10
Linear guide type	4 rows of circular arc grooves x 1 rail
Position detector	Resolvers
Resolution (Pulse/rotation)	16384

Note 1. Positioning repeatability in one direction.  
 Note 2. When the stroke is longer than 550mm, resonance of the ball screw may occur depending on the operation conditions (critical speed). In this case, reduce the speed setting on the program by referring to the maximum speeds shown in the table above.  
 Note 3. Position detectors (resolvers) are common to incremental and absolute specifications. If the controller has a backup function then it will be absolute specifications.

## Allowable overhang

	Horizontal installation (Unit: mm)			Wall installation (Unit: mm)			Vertical installation (Unit: mm)					
	A	B	C	A	B	C	A	C				
Lead 20	5kg	197	76	120	5kg	104	67	174	Lead 12	1kg	447	448
	10kg	100	32	54	10kg	37	23	72		2kg	214	216
	12kg	85	25	43	12kg	27	15	55		3kg	137	138
Lead 12	5kg	364	89	188	5kg	171	81	340	Lead 6	4kg	98	99
	10kg	203	39	87	10kg	69	32	172		2kg	244	245
	15kg	139	22	51	15kg	33	15	100		4kg	113	113
Lead 6	20kg	103	14	33	20kg	15	6	55	Lead 6	6kg	69	69
	10kg	403	43	113	10kg	94	36	369		8kg	46	46
	20kg	214	16	43	20kg	25	9	157				
Lead 6	30kg	140	6	20	30kg	0	0	14				
	40kg	113	0	8	40kg	0	0	0				

Note. Distance from center of slider top to center of gravity of object being carried at a guide service life of 10,000 km.

## Static loading moment

(Unit: N·m)		
MY	MP	MR
70	95	110

## Controller

Controller	Operation method
SR1-X05	Programming / I/O point trace / Remote command / Operation using RS-232C communication
RCX221/222	
RCX240/340	
TS-X105	I/O point trace / Remote command
TS-X205	
RDV-X205-RBR1	Pulse train control

## F8

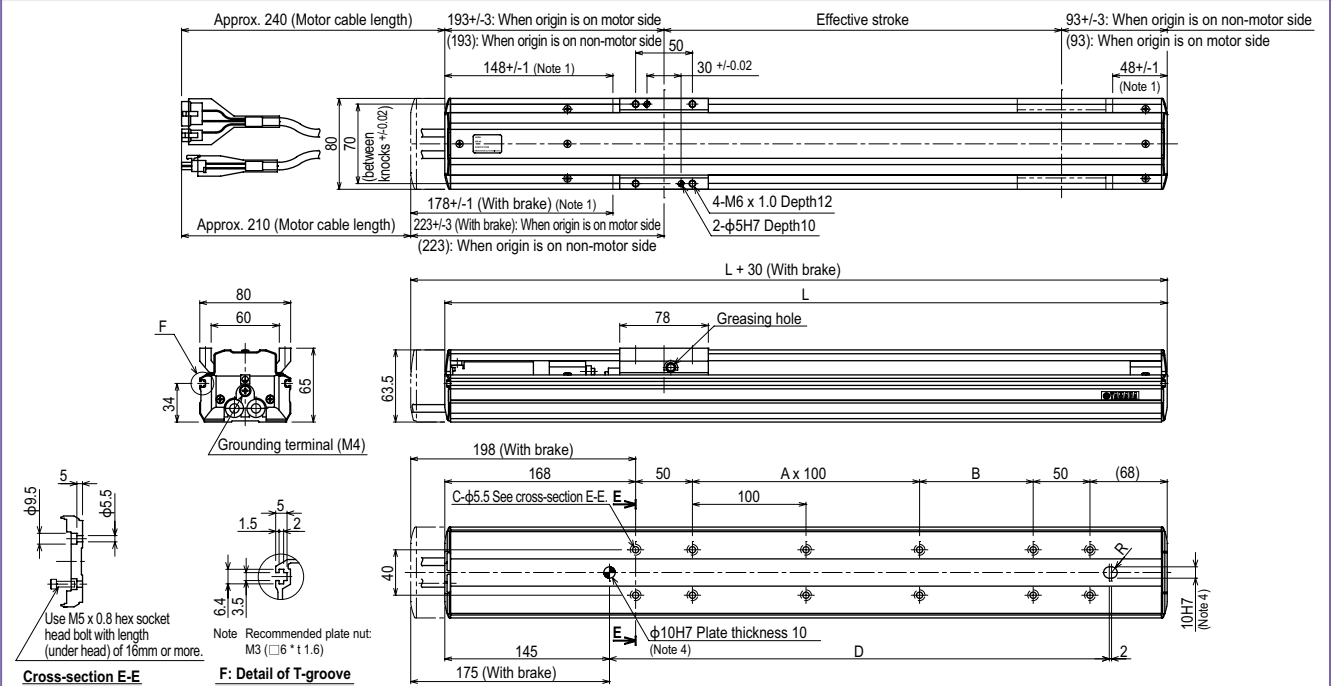

Effective stroke	L	Stroke (mm)															
		150	200	250	300	350	400	450	500	550	600	650	700	750	800		
A	0	0	1	1	2	2	3	3	4	4	5	5	6	6			
B	100	150	100	150	100	150	100	150	100	150	100	150	100	150			
C	8	8	10	10	12	12	14	14	16	16	18	18	20	20			
D	240	290	340	390	440	490	540	590	640	690	740	790	840	890			
Weight (kg)		3.6	3.9	4.2	4.4	4.7	5.0	5.3	5.6	5.9	6.2	6.4	6.7	7.0	7.3		
Maximum speed (mm/sec)	Lead 20	1200															
	Lead 12	720															
	Lead 6	360															
	Speed setting																

Note 1. Stop positions are determined by the mechanical stoppers at both ends.  
 Note 2. When installing the robot, do not use washers inside the robot body.  
 Note 3. Minimum bend radius of motor cable is R50.  
 Note 4. When using this φ10 knock-pin hole to position the robot body, the knock-pin must not protrude more than 10mm inside the robot body.  
 Note 5. Weight of models with no brake. The weight of brake-attached models is 0.3 kg heavier than the models with no brake shown in the table.  
 Note 6. When the stroke is longer than 550mm, resonance of the ball screw may occur depending on the operation conditions (critical speed). In this case, reduce the speed setting on the program by referring to the maximum speeds shown in the table above.

# F8L

- High lead: Lead 30
- Origin on the non-motor side is selectable

## Ordering method

**F8L**

<b>Model</b>	<b>Lead designation</b> 30: 30mm 20: 20mm 10: 10mm 5: 5mm	<b>Brake</b> No entry: No brakes BK: Brakes provided	<b>Origin position change</b> None: Standard Z: Non-motor side	<b>Grease type</b> None: Standard GC: Clean	<b>Stroke</b> 150 to 1050 (50mm pitch)	<b>Cable length</b> 3L: 3.5m 5L: 5m 10L: 10m 3K/5K/10K (Flexible cable)
--------------	---	--	--	---	--	--

<b>TSX</b>	<b>SR1-X</b>	<b>RDV-X</b>
<b>Positioner</b> TS-X	<b>Controller</b> 05	<b>Driver</b> 2
<b>Driver: Power supply voltage / Power capacity</b> 105: 100V/100W or less 205: 200V/100W or less	<b>Driver: Power capacity</b> 05: 100W or less	<b>Power supply voltage</b> 2: AC200V
<b>LCD monitor</b> No entry: None L: With LCD	<b>Usable for CE</b> No entry: Standard E: CE marking	<b>Driver: Power capacity</b> 05: 100W or less
<b>I/O selection</b> NP: NPN PN: PNP CC: CC-Link DN: DeviceNet™ EP: EtherNet/IP™ PT: PROFINET GW: No I/O board	<b>I/O selection</b> N: NPN P: PNP CC: CC-Link DN: DeviceNet™ PB: PROFIBUS	<b>Battery</b> B: With battery (Absolute) N: None (Incremental)
<b>Battery</b> B: With battery (Absolute) N: None (Incremental)	<b>Battery</b> B: With battery (Absolute) N: None (Incremental)	<b>Regenerative unit</b> RBR1

- Note 1. The model with a lead of 30mm cannot select specifications with brake (vertical specifications).  
 Note 2. The robot cable is standard cable (3L/5L/10L), but can be changed to flexible cable. See P.596 for details on robot cable.  
 Note 3. See P.500 for DIN rail mounting bracket.  
 Note 4. Select this selection when using the gateway function. For details, see P.62.

## Specifications

<b>AC servo motor output (W)</b>	100		
<b>Repeatability</b> Note 1 (mm)	+/-0.01		
<b>Deceleration mechanism</b>	Ball screw		
<b>Ball screw lead (mm)</b>	30	20	10
<b>Maximum speed</b> Note 2 (mm/sec)	1800	1200	600
<b>Maximum payload</b> (kg)	Horizontal 7	Vertical 4	5
<b>Rated thrust (N)</b>	56	84	169
<b>Stroke (mm)</b>	150 to 1050 (50mm pitch)		
<b>Overall length (mm)</b>	Horizontal Stroke+300	Vertical Stroke+292	Stroke+322
<b>Maximum dimensions of cross section of main unit (mm)</b>	W80 x H65		
<b>Cable length (m)</b>	Standard: 3.5 / Option: 5, 10		
<b>Linear guide type</b>	4 rows of circular arc grooves x 1 rail		
<b>Position detector</b>	Resolvers Note 3		
<b>Resolution (Pulse/rotation)</b>	16384		

- Note 1. Positioning repeatability in one direction.  
 Note 2. When the stroke is longer than 650mm, resonance of the ball screw may occur depending on the operation conditions (critical speed). In this case, reduce the speed setting on the program by referring to the maximum speeds shown in the table below.  
 Note 3. Position detectors (resolvers) are common to incremental and absolute specifications. If the controller has a backup function then it will be absolute specifications.

## Allowable overhang

	Horizontal installation (Unit: mm)			Wall installation (Unit: mm)			Vertical installation (Unit: mm)				
	A	B	C	A	B	C	A	B	C		
Lead 30	5kg	112	80	80	5kg	55	57	77	2kg	236	240
Lead 20	7kg	78	43	49	7kg	21	19	34	4kg	106	110
	5kg	211	108	147	5kg	119	89	176	2kg	310	311
	10kg	116	45	69	10kg	38	26	69	4kg	141	143
	15kg	76	24	39	15kg	7	0	16	6kg	85	86
Lead 10	20kg	58	14	26	20kg	0	0	0	8kg	57	58
	10kg	251	56	122	10kg	85	39	202	5kg	123	124
	20kg	121	20	46	20kg	7	0	30	10kg	47	48
	30kg	74	8	20	30kg	0	0	0	15kg	22	22
Lead 5	40kg	35	0	6	40kg	0	0	0	16kg	19	19
	20kg	249	23	62	20kg	19	7	140			
	30kg	170	10	29	30kg	0	0	0			
	40kg	138	4	12	40kg	0	0	0			
	50kg	51	0	0	50kg	0	0	0			

Note. Distance from center of slider top to center of gravity of object being carried at a guide service life of 10,000 km.

## Static loading moment

(Unit: N·m)		
MY	MP	MR
70	95	110

## Controller

Controller	Operation method
SR1-X05	Programming / I/O point trace / Remote command / Operation using RS-232C communication
RCX221/222	
RCX240/340	
TS-X105	I/O point trace / Remote command
TS-X205	
RDV-X205-RBR1	Pulse train control

## F8L

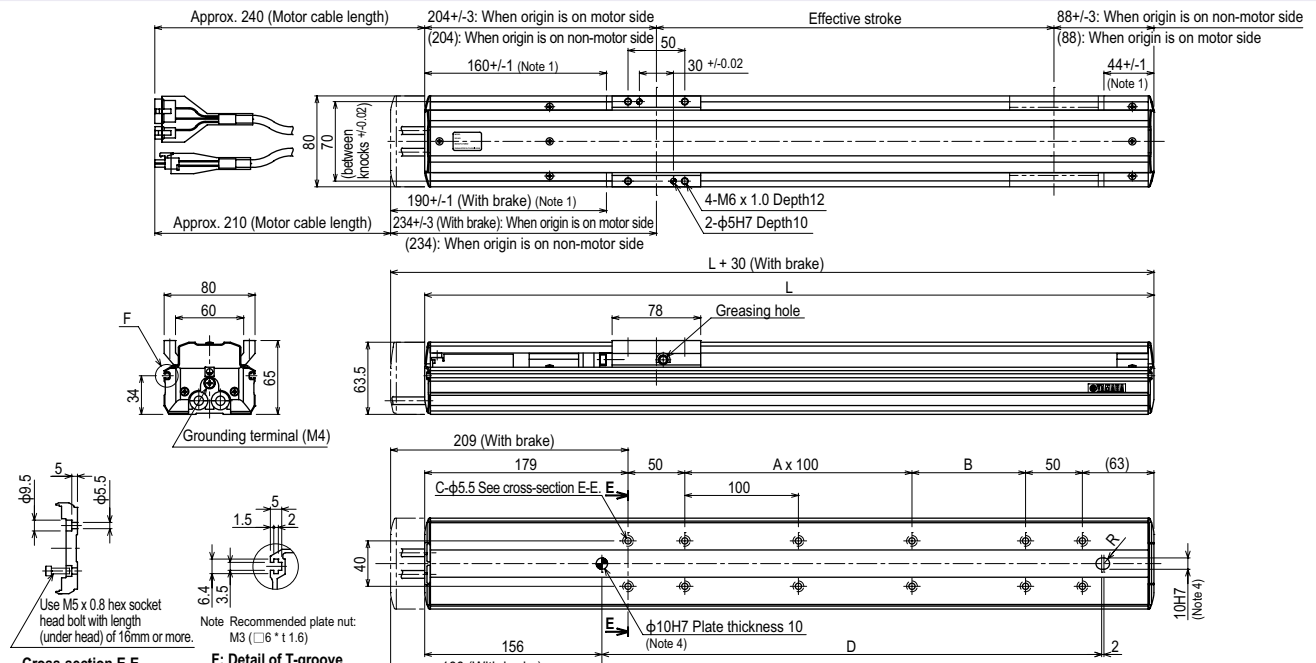

Effective stroke	Cross-section E-E																			
	150	200	250	300	350	400	450	500	550	600	650	700	750	800	850	900	950	1000	1050	
L	442	492	542	592	642	692	742	792	842	892	942	992	1042	1092	1142	1192	1242	1292	1342	
A	0	0	1	1	2	2	3	3	4	4	5	5	6	6	7	7	8	8	9	
B	100	150	100	150	100	150	100	150	100	150	100	150	100	150	100	150	100	150	100	
C	8	8	10	10	12	12	14	14	16	16	18	18	20	20	22	22	24	24	26	
D	240	290	340	390	440	490	540	590	640	690	740	790	840	890	940	990	1040	1090	1140	
Weight (kg) Note 5	3.9	4.2	4.5	4.8	5.1	5.4	5.7	6.1	6.4	6.7	7.0	7.3	7.6	7.9	8.2	8.5	8.8	9.2	9.5	
Maximum speed (mm/sec) Note 6																				
	Lead 20	1200																		
	Lead 10	600																		
	Lead 5	300																		
Speed setting																				
	Lead 20	85%																		
Lead 10	75%																			
Lead 5	65%																			
Speed setting	60%																			
Speed setting	55%																			
Speed setting	50%																			
Speed setting	45%																			
Speed setting	40%																			

- Note 1. Stop positions are determined by the mechanical stoppers at both ends.  
 Note 2. When installing the robot, do not use washers inside the robot body.  
 Note 3. Minimum bend radius of motor cable is R50.  
 Note 4. When using this φ10 knock-pin hole to position the robot body, the knockpin must not protrude more than 10mm inside the robot body.  
 Note 5. Weight of models with no brake. The weight of brake-attached models is 0.3 kg heavier than the models with no brake shown in the table.  
 Note 6. When the stroke is longer than 650mm, resonance of the ball screw may occur depending on the operation conditions (critical speed). In this case, reduce the speed setting on the program by referring to the maximum speeds shown in the table above.

F8L High lead type: Lead 30

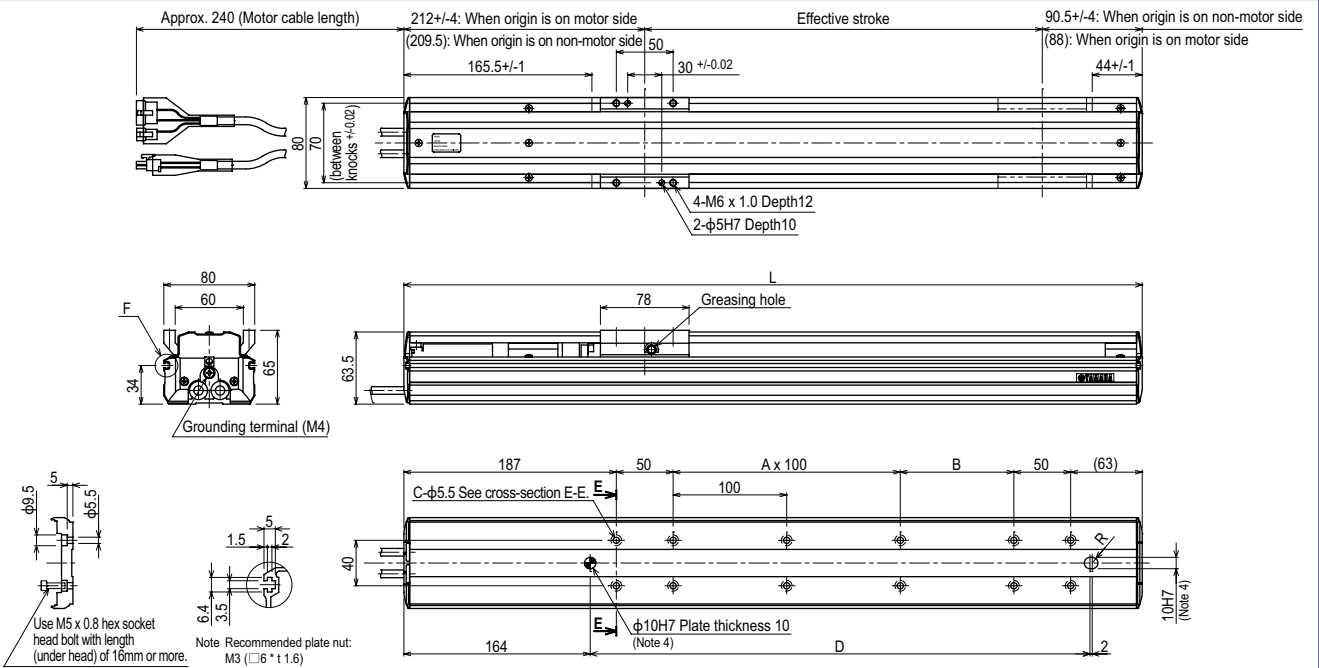

Cross-section E-E F: Detail of T-groove

Effective stroke	150	200	250	300	350	400	450	500	550	600	650	700	750	800	850	900	950	1000	1050
L	450	500	550	600	650	700	750	800	850	900	950	1000	1050	1100	1150	1200	1250	1300	1350
A	0	0	1	1	2	2	3	3	4	4	5	5	6	6	7	7	8	8	9
B	100	150	100	150	100	150	100	150	100	150	100	150	100	150	100	150	100	150	100
C	8	8	10	10	12	12	14	14	16	16	18	18	20	20	22	22	24	24	26
D	240	290	340	390	440	490	540	590	640	690	740	790	840	890	940	990	1040	1090	1140
Weight (kg)	3.9	4.2	4.5	4.8	5.1	5.4	5.7	6.1	6.4	6.7	7.0	7.3	7.6	7.9	8.2	8.5	8.8	9.2	9.5
Maximum speed <sup>Notes</sup> (mm/sec)	Lead 30	1800										1530	1350	1170	1080	990	900	810	720
	Speed setting	-										85%	75%	65%	60%	55%	50%	45%	40%

Note 1. Stop positions are determined by the mechanical stoppers at both ends.  
 Note 2. When installing the robot, do not use washers inside the robot body.  
 Note 3. Minimum bend radius of motor cable is R50.  
 Note 4. When using this φ10 knockpin hole to position the robot body, the knockpin must not protrude more than 10mm inside the robot body.

Note 5. When the stroke is longer than 650mm, resonance of the ball screw may occur depending on the operation conditions (critical speed). In this case, reduce the speed setting on the program by referring to the maximum speeds shown in the table above.

# F8LH

● Origin on the non-motor side is selectable

## Ordering method

<b>F8LH</b>	<b>Model</b>	<b>Lead designation</b> 20: 20mm 10: 10mm 5: 5mm	<b>Origin position change</b> None: Standard Z: Non-motor side	<b>Grease type</b> None: Standard GC: Clean	<b>Stroke</b> 150 to 1050 (50mm pitch)	<b>Cable length<sup>Note1</sup></b> 3L: 3.5m 5L: 5m 10L: 10m 3K/5K/10K (Flexible cable)	<b>TSX</b>	<b>Positioner<sup>Note2</sup></b> TS-X	<b>Driver: Power supply voltage / Power capacity</b> 105: 100V/100W or less 205: 200V/100W or less	<b>LCD monitor</b> No entry: None L: With LCD	<b>I/O selection</b> NP: NPN PN: PNP CC: CC-Link DN: DeviceNet™ EP: EtherNet/IP™ PT: PROFINET GW: No I/O board <sup>Note3</sup>	<b>Battery</b> B: With battery (Absolute) N: None (Incremental)
							<b>SR1-X</b>	<b>Controller</b>	<b>05</b> Driver: Power capacity 05: 100W or less	<b>Usable for CE</b> No entry: Standard E: CE marking	<b>I/O selection</b> N: NPN P: PNP CC: CC-Link DN: DeviceNet™ PB: PROFINET	<b>Battery</b> B: With battery (Absolute) N: None (Incremental)
							<b>RDV-X</b>	<b>Driver</b>	<b>2</b> Power supply voltage 2: AC200V	<b>05</b> Driver: Power capacity 05: 100W or less	<b>RBR1</b>	<b>Regenerative unit</b>

Note 1. The robot cable is standard cable (3L/5L/10L), but can be changed to flexible cable. See P.596 for details on robot cable.  
Note 2. See P.500 for DIN rail mounting bracket.  
Note 3. Select this selection when using the gateway function. For details, see P.62.

## Specifications

AC servo motor output (W)	100
Repeatability <sup>Note 1</sup> (mm)	+/-0.01
Deceleration mechanism	Ball screw
Ball screw lead (mm)	20 10 5
Maximum speed <sup>Note 2</sup> (mm/sec)	1200 600 300
Maximum payload (kg)	Horizontal 30 60 80
Rated thrust (N)	84 169 339
Stroke (mm)	150 to 1050 (50mm pitch)
Overall length (mm)	Horizontal Stroke+368
Maximum dimensions of cross section of main unit (mm)	W80 x H65
Cable length (m)	Standard: 3.5 / Option: 5.10
Linear guide type	4 rows of circular arc grooves x 1 rail
Position detector	Resolvers <sup>Note 3</sup>
Resolution (Pulse/rotation)	16384

Note 1. Positioning repeatability in one direction.  
Note 2. When the stroke is longer than 600mm, resonance of the ball screw may occur depending on the operation conditions (critical speed). In this case, reduce the speed setting on the program by referring to the maximum speeds shown in the table below.  
Note 3. Position detectors (resolvers) are common to incremental and absolute specifications. If the controller has a backup function then it will be absolute specifications.

## Allowable overhang<sup>Note</sup>

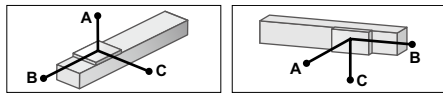

	Horizontal installation (Unit: mm)			Wall installation (Unit: mm)		
	A	B	C	A	B	C
Lead 20	573	256	176	10kg 147	215	515
20kg	334	116	81	20kg 53	75	255
30kg	279	70	50	30kg 20	29	160
Lead 10	629	137	111	40kg 80	99	545
20kg	479	57	47	40kg 15	19	270
60kg	382	30	25	60kg -	-	-
Lead 5	1094	148	127	20kg 96	112	1005
40kg	851	63	54	40kg 22	26	604
60kg	714	34	29	60kg -	-	-
80kg	601	20	17	80kg -	-	-

Note. Distance from center of slider top to center of gravity of object being carried at a guide service life of 10,000 km.

## Static loading moment

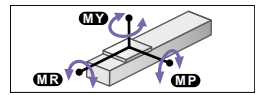

	(Unit: N·m)		
	MY	MP	MR
	128	163	143

## Controller

Controller	Operation method
SR1-X05 RCX221/222 RCX240/340	Programming / I/O point trace / Remote command / Operation using RS-232C communication
TS-X105	I/O point trace / Remote command
TS-X205	Remote command
RDV-X205-RBR1	Pulse train control

## F8LH

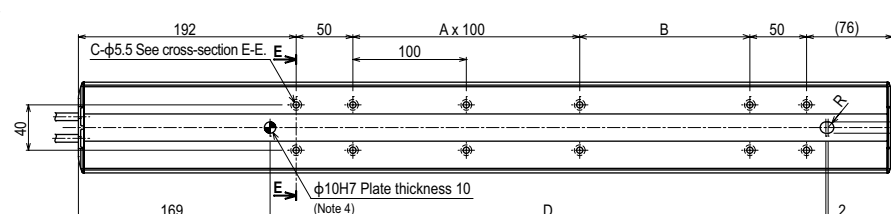
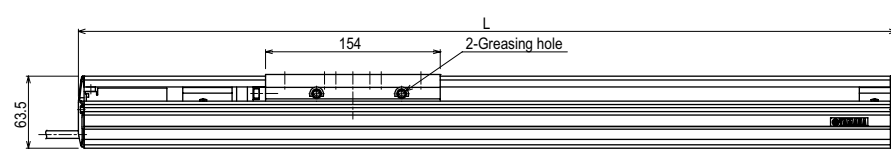
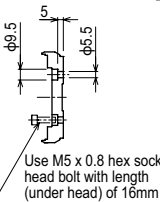
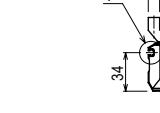
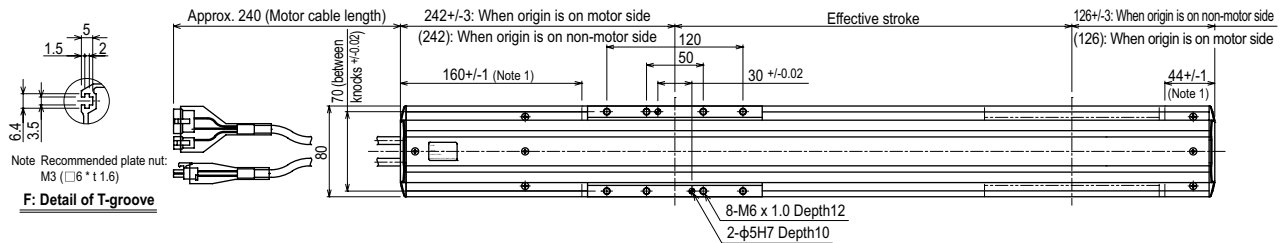

### Cross-section E-E

Effective stroke	150	200	250	300	350	400	450	500	550	600	650	700	750	800	850	900	950	1000	1050	
L	518	568	618	668	718	768	818	868	918	968	1018	1068	1118	1168	1218	1268	1318	1368	1418	
A	0	1	1	2	2	3	3	4	4	5	5	6	6	7	7	8	8	9	9	
B	150	100	150	100	150	100	150	100	150	100	150	100	150	100	150	100	150	100	150	
C	8	10	10	12	12	14	14	16	16	18	18	20	20	22	22	24	24	26	26	
D	290	340	390	440	490	540	590	640	690	740	790	840	890	940	990	1040	1090	1140	1190	
Weight (kg)	4.7	5.0	5.3	5.6	5.9	6.2	6.6	6.9	7.2	7.5	7.8	8.1	8.4	8.7	9.0	9.3	9.7	10.0	10.3	
Maximum speed <sup>Note 5</sup> (mm/sec)	Lead 20	1200																		
	Lead 10	600																		
	Lead 5	300																		
	Speed setting	-																		
Maximum speed <sup>Note 5</sup> (mm/sec)	Lead 20	1020	900	780	720	660	600	540	480	420	510	450	390	360	330	300	270	240	210	
	Lead 10	255	225	195	180	165	150	135	120	105	255	225	195	180	165	150	135	120	105	
	Lead 5	85%	75%	65%	60%	55%	50%	45%	40%	35%	85%	75%	65%	60%	55%	50%	45%	40%	35%	
	Speed setting	-																		
	Speed setting	-																		

Note 1. Stop positions are determined by the mechanical stoppers at both ends.  
Note 2. When installing the robot, do not use washers inside the robot body.  
Note 3. Minimum bend radius of motor cable is R50.  
Note 4. When using this φ10 knockpin hole to position the robot body, the knockpin must not protrude more than 10mm inside the robot body.  
Note 5. When the stroke is longer than 600mm, resonance of the ball screw may occur depending on the operation conditions (critical speed). In this case, reduce the speed setting on the program by referring to the maximum speeds shown in the table above.



# F10

● High lead: Lead 30

● Origin on the non-motor side is selectable: Lead 10-20-30

Note. Strokes longer than 1050mm are special order items. Please consult us for delivery time.

## Ordering method

### F10

Model	Lead designation	Brake	Cable entry location	Origin position change	Grease type	Stroke	Cable length
	30: 30mm 20: 20mm 10: 10mm 5: 5mm	No entry: No brakes BK: Brakes provided	No entry: Standard (S) U: From the top	None: Standard Z: Non-motor side	None: Standard GC: Clean	Lead 20-10-5: 150 to 1050 (50mm pitch) Lead 30: 150 to 1250 (50mm pitch)	3L: 3.5m 5L: 5m 10L: 10m 3K/5K/10K (Flexible cable)

- Note 1. The model with a lead of 30mm cannot select specifications with brake (vertical specifications).  
 Note 2. If selecting 5mm lead specifications then the origin point cannot be changed to the non-motor side.  
 Note 3. The robot cable is standard cable (3L/5L/10L), but can be changed to flexible cable. See P.596 for details on robot cable.  
 Note 4. See P.500 for DIN rail mounting bracket.  
 Note 5. Select this selection when using the gateway function. For details, see P.62.

### TSX

Positioner	Driver: Power-supply voltage	Regenerative unit	LCD monitor	I/O selection	Battery
TS-X	105: 100V/100W or less 205: 200V/100W or less	No entry: None R: With RGT	No entry: None L: With LCD	NP: NPN PN: PNP CC: CC-Link DN: DeviceNet™ EP: EtherNet/IP™ PT: PROFINET GW: No I/O board	B: With battery (Absolute) N: None (Incremental)

### SR1-X

Controller	Driver: Power capacity	Usable for CE	Regenerative unit	I/O selection	Battery
05	05: 100W or less	No entry: Standard E: CE marking	No entry: None R: With RGT	N: NPN P: PNP CC: CC-Link DN: DeviceNet™ PB: PROFIBUS	B: With battery (Absolute) N: None (Incremental)

### RDV-X

Driver	Power-supply voltage	Driver: Power capacity	Regenerative unit
2	2: AC200V	05: 100W or less	

## Specifications

AC servo motor output (W)	100
Repeatability (mm)	+/-0.01
Deceleration mechanism	Ball screw
Ball screw lead (mm)	30 20 10 5
Maximum speed (mm/sec)	1800 1200 600 300
Maximum payload (kg)	Horizontal: 15 20 40 60 Vertical: - 4 10 20
Rated thrust (N)	56 84 169 339
Stroke (mm)	150 to 1250 (50mm pitch)
Overall length (mm)	Horizontal: Stroke+260 Vertical: Stroke+290
Maximum dimensions of cross section of main unit (mm)	W110 x H71
Cable length (m)	Standard: 3.5 / Option: 5.10
Linear guide type	4 rows of circular arc grooves x 1 rail
Position detector	Resolvers
Resolution (Pulse/rotation)	16384

- Note 1. Positioning repeatability in one direction.  
 Note 2. When the stroke is longer than 700mm, resonance of the ball screw may occur depending on the operation conditions (critical speed). In this case, reduce the speed setting on the program by referring to the maximum speeds shown in the table below.  
 Note 3. Strokes longer than 1050mm are available only for high lead (Lead 30). (Special order item)  
 Note 4. Position detectors (resolvers) are common to incremental and absolute specifications. If the controller has a backup function then it will be absolute specifications.

## Allowable overhang

Lead	Horizontal installation (Unit: mm)			Wall installation (Unit: mm)			Vertical installation (Unit: mm)		
	A	B	C	A	B	C	A	B	C
Lead 30	5kg: 491	273	215	5kg: 206	209	480	1kg: 600	600	600
Lead 20	15kg: 223	61	63	15kg: 45	0	177	2kg: 649	691	
	5kg: 937	282	259	5kg: 250	213	905	4kg: 306	347	
Lead 10	10kg: 487	121	116	10kg: 99	51	438	8kg: 142	183	
	20kg: 236	40	44	20kg: 21	0	149	10kg: 102	144	
Lead 5	15kg: 389	71	74	10kg: 105	53	550	10kg: 105	146	
	30kg: 179	17	20	20kg: 22	0	230	15kg: 51	93	
Lead 5	40kg: 106	0	0	30kg: 0	0	0	20kg: 25	66	
	30kg: 419	19	20	10kg: 107	54	1410			
Lead 5	50kg: 0	0	0	20kg: 22	0	540			
	60kg: 0	0	0	30kg: 0	0	0			

Note. Distance from center of slider top to center of gravity of object being carried at a guide service life of 10,000 km.

## Static loading moment

MY	MP	MR
131	131	115

(Unit: N·m)

## Controller

Controller	Operation method
SR1-X05 RCX221/222 RCX240/340	Programming / I/O point trace / Remote command / Operation using RS-232C communication
TS-X105 TS-X205 RDV-X05-RBR1	I/O point trace / Remote command / Pulse train control

Note. Regenerative unit is required when the models used vertically and with 700mm or larger stroke.

## F10

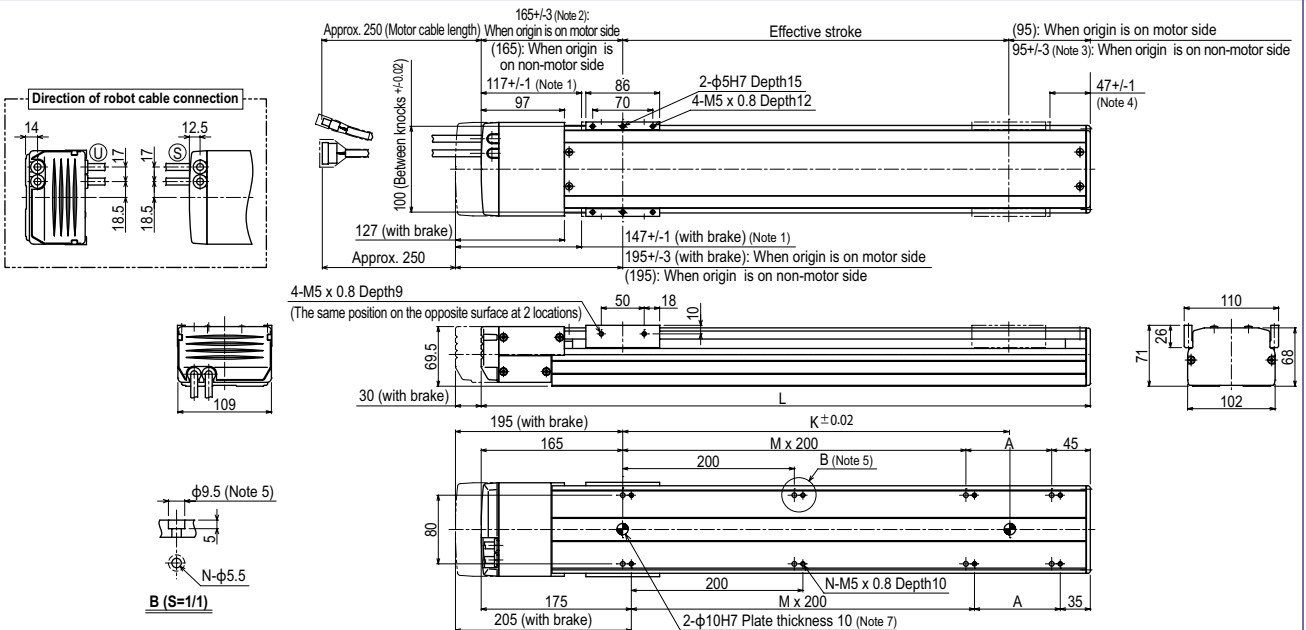

- Note 1. Stop positions are determined by the mechanical stoppers at both ends.  
 Note 2. 167.5+/-4 when the high lead specification (Lead 30) is used.  
 Note 3. 95+/-4 when the high lead specification (Lead 30) is used.  
 Note 4. 44.5+/-1 when the high lead specification (Lead 30) is used.  
 Note 5. When installing the unit, washers, etc., cannot be used in the  $\phi 9.5$  counter bore hole.  
 Note 6. Minimum bend radius of motor cable is R50.  
 Note 7. When using this  $\phi 10$  knock-pin hole to position the robot body, the knockpin must not protrude more than 10mm inside the robot body.  
 Note 8. Weight of models with no brake. The weight of brake-attached models is 0.6 kg heavier than the models with no brake shown in the table.

Effective stroke	150	200	250	300	350	400	450	500	550	600	650	700	750	800	850	900	950	1000	1050	1100	1150	1200	1250
L	410	460	510	560	610	660	710	760	810	860	910	960	1010	1060	1110	1160	1210	1260	1310	1360	1410	1460	1510
A	200	50	100	150	200	50	100	150	200	50	100	150	200	50	100	150	200	50	100	150	200	50	100
M	0	1	1	1	1	2	2	2	2	3	3	3	3	4	4	4	4	5	5	5	5	6	6
N	4	6	6	6	6	8	8	8	8	10	10	10	10	12	12	12	12	14	14	14	14	16	16
K	150	200	250	300	350	400	450	500	550	600	650	700	750	800	850	900	950	1000	1050	1100	1150	1200	1250
Weight (kg)	5.5	5.7	5.8	6.2	6.5	6.9	7.3	7.7	8.1	8.5	8.8	9.2	9.6	10.0	10.4	10.8	11.1	11.5	11.9	12.3	12.7	13.1	13.5
Maximum speed (mm/sec)	1800	1200	600	300									1440	960	780	600	540	480	390	300	270		
Speed setting													80%	195	150	135							

- Note 9. When the stroke is longer than 700mm, resonance of the ball screw may occur depending on the operation conditions (critical speed). In this case, reduce the speed setting on the program by referring to the maximum speeds shown in the table above.  
 Note 10. Strokes longer than 1050mm are special order items. Please contact us for speed setting.

Controller

SR1-X ▶ 518

TS-X ▶ 492

RDV-X ▶ 506

# F10H

- High lead: Lead 30
- Origin on the non-motor side is selectable: Lead 10-20-30

## Ordering method

**F10H**

Model	Lead designation	Brake	Cable entry location	Origin position change	Grease type	Stroke	Cable length
	30: 30mm 20: 20mm 10: 10mm 5: 5mm	No entry: No brakes BK: Brakes provided	No entry: Standard (S) U: From the top	None: Standard Z: Non-motor side	None: Standard GC: Clean	Lead 20-10-5: 150 to 1000 (50mm pitch) Lead 30: 150 to 1000 (50mm pitch)	3L: 3.5m 5L: 5m 10L: 10m 3K/5K/10K (Flexible cable)

**TSX**

Positioner	Driver: Power-supply voltage / Power capacity	Regenerative unit	LCD monitor	I/O selection	Battery
TS-X	110: 100V/200W 210: 200V/200W	No entry: None R: With RGT	No entry: None L: With LCD	N: NPN P: PNP CC: CC-Link DN: DeviceNet™ EP: EtherNet/IP™ PT: PROFINET GW: No I/O board	B: With battery (Absolute) N: None (Incremental)

**SR1-X 10**

Controller	Driver: Power capacity	Usable for CE	Regenerative unit	I/O selection	Battery
SR1-X 10	10: 200W	No entry: Standard E: CE marking	No entry: None R: With RGT	N: NPN P: PNP CC: CC-Link DN: DeviceNet™ PB: Profibus	B: With battery (Absolute) N: None (Incremental)

**RDV-X 2 10 RBR1**

Driver	Power-supply voltage	Driver: Power capacity	Regenerative unit
RDV-X 2 10 RBR1	2: AC200V	10: 200W or less	

Note 1. The model with a lead of 30mm cannot select specifications with brake (vertical specifications).  
 Note 2. If selecting 5mm lead specifications then the origin point cannot be changed to the non-motor side.  
 Note 3. The robot cable is standard cable (3L/5L/10L), but can be changed to flexible cable. See P.596 for details on robot cable.  
 Note 4. See P.500 for DIN rail mounting bracket.  
 Note 5. Select this selection when using the gateway function. For details, see P.62.

## Specifications

AC servo motor output (W)	200		
Repeatability (mm)	±/ - 0.01		
Deceleration mechanism	Ball screw		
Ball screw lead (mm)	30	20	10
Maximum speed (mm/sec)	1800	1200	600
Maximum payload (kg)	Horizontal	Vertical	
	25	40	80
		8	20
Rated thrust (N)	113	170	341
Stroke (mm)	150 to 1000		
Overall length (mm)	Horizontal	Stroke+355	
	Vertical	Stroke+385	
Maximum dimensions of cross section of main unit (mm)	W110 × H71		
Cable length (m)	Standard: 3.5 / Option: 5.10		
Linear guide type	4 rows of circular arc grooves × 1 rail		
Position detector	Resolvers		
Resolution (Pulse/rotation)	16384		

- Note 1. Positioning repeatability in one direction.  
 Note 2. When the stroke is longer than 600mm, resonance of the ball screw may occur depending on the operation conditions (critical speed). In this case, reduce the speed setting on the program by referring to the maximum speeds shown in the table below. When the movement distance is short, the speed may not reach the maximum speed according to the payload.  
 Note 3. Position detectors (resolvers) are common to incremental and absolute specifications. If the controller has a backup function then it will be absolute specifications.

## Allowable overhang

Installation	Horizontal installation (Unit: mm)			Wall installation (Unit: mm)			Vertical installation (Unit: mm)		
	A	B	C	A	B	C	A	C	
Lead 30	1181	681	219	193	570	1062	4kg	1650	1650
Lead 20	772	298	99	65	187	549	6kg	1104	1104
Lead 10	1961	685	232	198	570	1786	8kg	832	832
Lead 5	949	301	103	65	187	732	10kg	927	927
Lead 30	432	109	38	0	0	0	15kg	614	614
Lead 20	30k	1615	239	84	100	283	20kg	458	458
Lead 10	50k	1131	112	39	66	187	15kg	752	752
Lead 5	80k	812	40	14	30k	43	20kg	560	560
Lead 30	60k	3091	112	39	20kg	94	379	7629	
Lead 20	80k	2330	64	23	25kg	93	264	5987	
Lead 10	100k	1733	36	12	30kg	66	187	4841	

Note. Distance from center of slider top to center of gravity of object being carried at a guide service life of 10,000 km.  
 Note. Service life is calculated for 600mm stroke models.

## Static loading moment

	MY	MP	MR
	348	348	160

(Unit: N·m)

## Controller

Controller	Operation method
SR1-X10 Note RCX221/222 RCX240/340	Programming / I/O point trace / Remote command / Operation using RS-232C communication
TS-X110 Note TS-X210 Note	I/O point trace / Remote command
RDV-X210- RBR1	Pulse train control

Note. When using the unit vertically, a regeneration unit is required.

## F10H

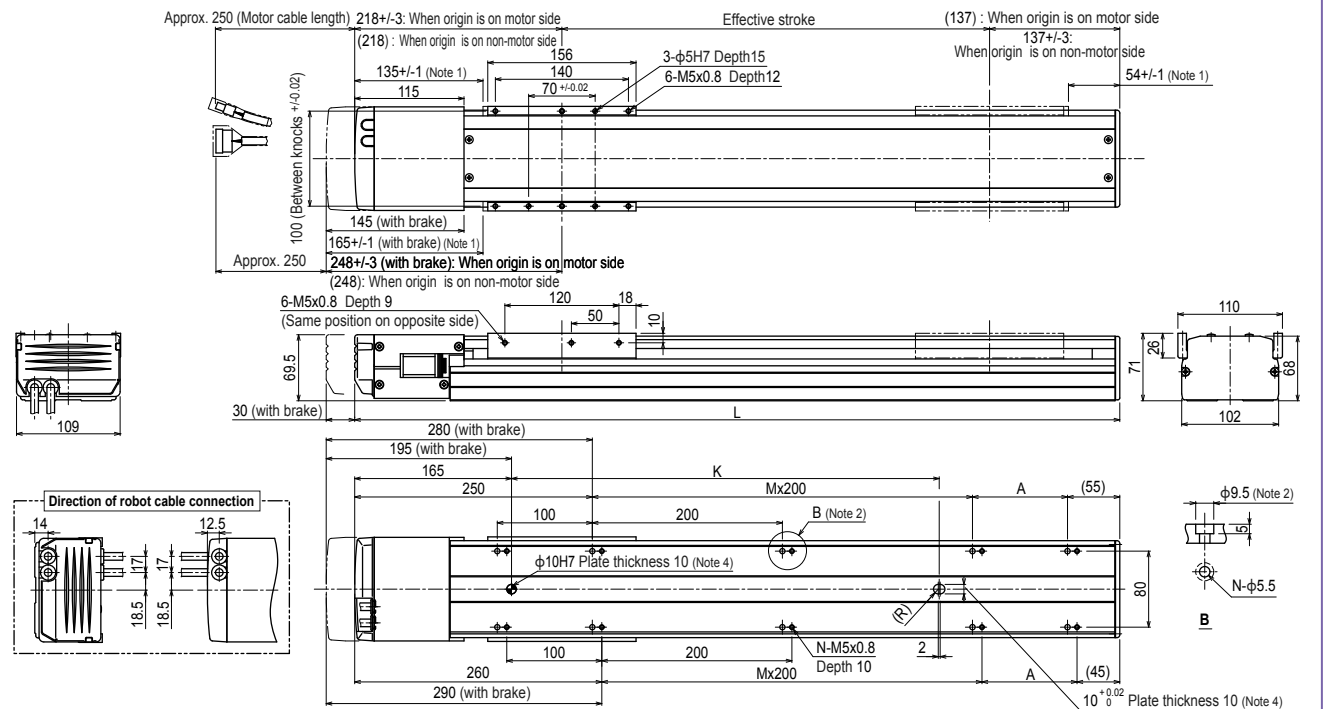

Effective stroke	150	200	250	300	350	400	450	500	550	600	650	700	750	800	850	900	950	1000
L	505	555	605	655	705	755	805	855	905	955	1005	1055	1105	1155	1205	1255	1305	1355
A	200	50	100	150	200	50	100	150	200	50	100	150	200	50	100	150	200	50
M	0	1	1	1	1	2	2	2	2	3	3	3	3	4	4	4	4	5
N	6	8	8	8	8	10	10	10	10	12	12	12	12	14	14	14	14	16
K	250	300	350	400	450	500	550	600	650	700	750	800	850	900	950	1000	1050	1100
Weight (kg) Note 5	6.9	7.3	7.7	8.1	8.4	8.8	9.2	9.6	10.0	10.3	10.7	11.1	11.5	11.9	12.2	12.6	13.0	13.4
Maximum speed (mm/sec) Note 6	1800	1200	600	300	1440	1260	1080	900	720	630	480	420	360	300	240	210	180	105
Speed setting	80%	70%	60%	50%	40%	35%												

Note 1. Stop positions are determined by the mechanical stoppers at both ends. When installing the unit, washers, etc. cannot be used in the φ9.5 counter bore hole.  
 Note 2. Minimum bend radius of motor cable is R50.  
 Note 3. When using this φ10 knock-pin hole to position the robot body, the knockpin must not protrude more than 10mm inside the robot body.  
 Note 4. Weight of models with no brake. The weight of brake-attached models is 0.5 kg heavier than the models with no brake shown in the table.  
 Note 5. When the stroke is longer than 600mm, resonance of the ball screw may occur depending on the operation conditions (critical speed). In this case, reduce the speed setting on the program by referring to the maximum speeds shown in the table above.

## F10H High lead type: Lead 30

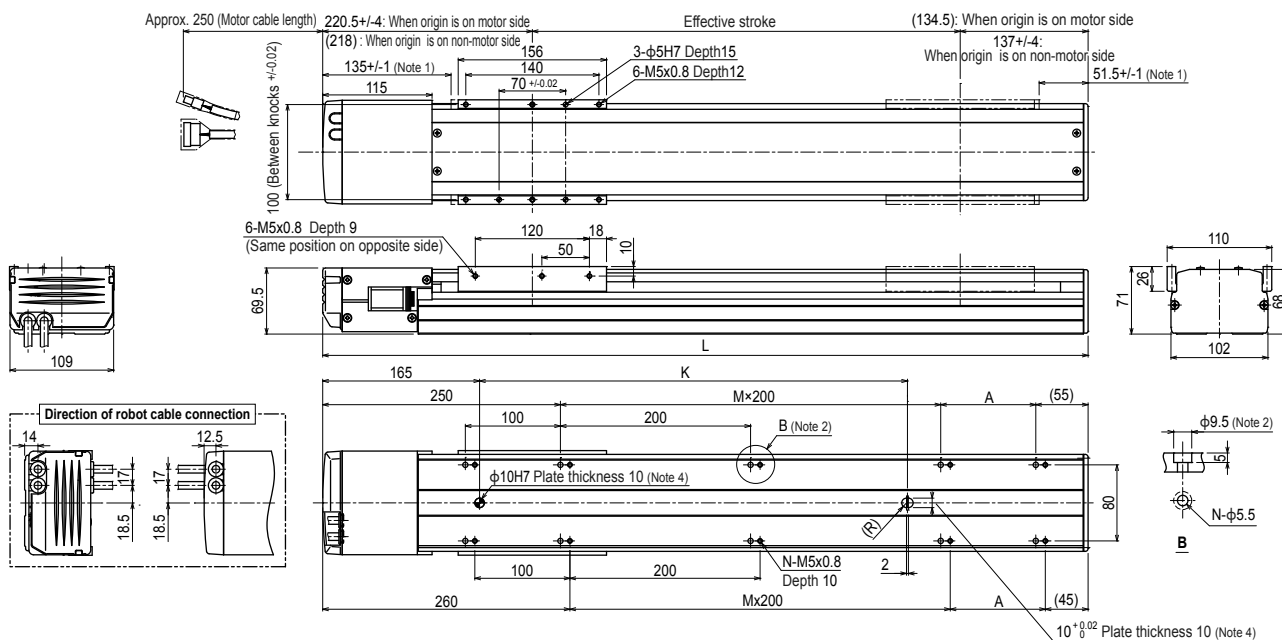

Effective stroke	150	200	250	300	350	400	450	500	550	600	650	700	750	800	850	900	950	1000		
L	505	555	605	655	705	755	805	855	905	955	1005	1055	1105	1155	1205	1255	1305	1355		
A	200	50	100	150	200	50	100	150	200	50	100	150	200	50	100	150	200	50		
M	0	1	1	1	1	2	2	2	3	3	3	3	4	4	4	4	4	5		
N	6	8	8	8	8	10	10	10	10	12	12	12	12	14	14	14	14	16		
K	250	300	350	400	450	500	550	600	650	700	750	800	850	900	950	1000	1050	1100		
Weight (kg)	6.9	7.3	7.7	8.1	8.4	8.8	9.2	9.6	10.0	10.3	10.7	11.1	11.5	11.9	12.2	12.6	13.0	13.4		
Maximum speed (mm/sec)	Lead 30											1440	1260	1080	900				720	630
	Lead 20											960	840	720	600				480	420
	Lead 10											480	420	360	300				240	210
	Lead 5											240	210	180	150				120	105
Speed setting											80%	70%	60%	50%				40%	35%	

Note 1. Stop positions are determined by the mechanical stoppers at both ends. Note 2. When installing the unit, washers, etc., cannot be used in the φ9.5 counter bore hole. Note 3. Minimum bend radius of motor cable is R50. Note 4. When using this φ10 knock-pin hole to position the robot body, the knock-pin must not protrude more than 10mm inside the robot body.

# F14

- High lead: Lead 30
- Origin on the non-motor side is selectable

Note. Strokes longer than 1050mm are special order items. Please consult us for delivery time.



## Ordering method

### F14

Model	Lead designation	Brake	Cable entry location	Origin position change	Grease type	Stroke	Cable length
	30: 30mm 20: 20mm 10: 10mm 5: 5mm	No entry: No brakes BK: Brakes provided	No entry: Standard (S) U: From the top R: From the right L: From the left	None: Standard Z: Non-motor side	None: Standard GC: Clean	Lead 20: 10:5 150 to 1050 (50mm pitch) Lead 30: 150 to 1250 (50mm pitch)	3L: 3.5m 5L: 5m 10L: 10m 3K/5K/10K (Flexible cable)

### TSX

Positioner	Driver: Power supply voltage Power capacity	Regenerative unit	LCD monitor	I/O selection	Battery
TS-X	105: 100V/100W or less 205: 200V/100W or less	No entry: None R: With RGT	No entry: None L: With LCD	NP: NPN PN: PNP CC: CC-Link DN: DeviceNet™ EP: EtherNet/IP™ PT: PROFINET GW: No I/O board	B: With battery (Absolute) N: None (Incremental)

### SR1-X

Controller	Driver: Power capacity	Usable for CE	Regenerative unit	I/O selection	Battery
05	05: 100W or less	No entry: Standard E: CE marking	No entry: None R: With RGT1	N: NPN P: PNP CC: CC-Link DN: DeviceNet™ PB: PROFIBUS	B: With battery (Absolute) N: None (Incremental)

### RDV-X

Driver	Power supply voltage	Driver: Power capacity	Regenerative unit
2	2: AC200V	05: 100W or less	RBR1

- Note 1. The model with a lead of 30mm cannot select specifications with brake (vertical specifications).  
 Note 2. The robot cable is standard cable (3L/5L/10L), but can be changed to flexible cable. See P.596 for details on robot cable.  
 Note 3. See P.500 for DIN rail mounting bracket.  
 Note 4. Select this selection when using the gateway function. For details, see P.62.

## Specifications

AC servo motor output (W)	100
Repeatability (mm)	+/-0.01
Deceleration mechanism	Ball screw
Ball screw lead (mm)	30 20 10 5
Maximum speed (mm/sec)	1800 1200 600 300
Maximum payload (kg)	Horizontal: 15 30 55 80 Vertical: - 4 10 20
Rated thrust (N)	56 84 169 339
Stroke (mm)	150 to 1250 (50mm pitch)
Overall length (mm)	Horizontal: Stroke+255 Vertical: Stroke+285
Maximum dimensions of cross section of main unit (mm)	W136 x H83
Cable length (m)	Standard: 3.5 / Option: 5.10
Linear guide type	4 rows of circular arc grooves x 2 rail
Position detector	Resolvers
Resolution (Pulse/rotation)	16384

- Note 1. Positioning repeatability in one direction.  
 Note 2. When the stroke is longer than 700mm, resonance of the ball screw may occur depending on the operation conditions (critical speed). In this case, reduce the speed setting on the program by referring to the maximum speeds shown in the table below.  
 Note 3. Strokes longer than 1050mm are available only for high lead (Lead 30). (Special order item)  
 Note 4. Position detectors (resolvers) are common to incremental and absolute specifications. If the controller has a backup function then it will be absolute specifications.

## Allowable overhang

Lead	Horizontal installation (Unit: mm)			Wall installation (Unit: mm)			Vertical installation (Unit: mm)		
	A	B	C	A	B	C	A	B	C
Lead 30	5kg 1756	1364	863	5kg 951	969	1286	1kg 600	600	600
Lead 20	15kg 1236	467	438	15kg 408	277	803	2kg 1200	1200	1200
Lead 10	5kg 2153	1366	980	5kg 1066	974	1578	4kg 1154	895	895
Lead 5	15kg 1193	465	430	15kg 402	276	775	8kg 634	492	492
Lead 30	30kg 1266	245	294	30kg 219	105	678	10kg 499	387	387
Lead 20	20kg 1132	353	361	20kg 312	189	690	10kg 587	456	456
Lead 10	40kg 872	183	218	40kg 140	57	402	15kg 383	297	297
Lead 5	55kg 946	140	184	55kg 92	0	345	20kg 281	218	218
Lead 30	50kg 1575	158	222	30kg 246	107	1095			
Lead 20	60kg 1493	135	194	40kg 167	64	798			
Lead 10	80kg 1466	107	159	60kg 88	20	508			

Note. Distance from center of slider top to center of gravity of object being carried at a guide service life of 10,000 km.

## Static loading moment

(Unit: N·m)		
MY	MP	MR
232	233	204

## Controller

Controller	Operation method
SR1-X05 RCX221/222 RCX240/340	Programming / I/O point trace / Remote command / Operation using RS-232C communication
TS-X105 TS-X205 RDV-X05-RBR1	I/O point trace / Remote command / Pulse train control

Note. Regenerative unit is required when the models used vertically and with 700mm or larger stroke.

## F14

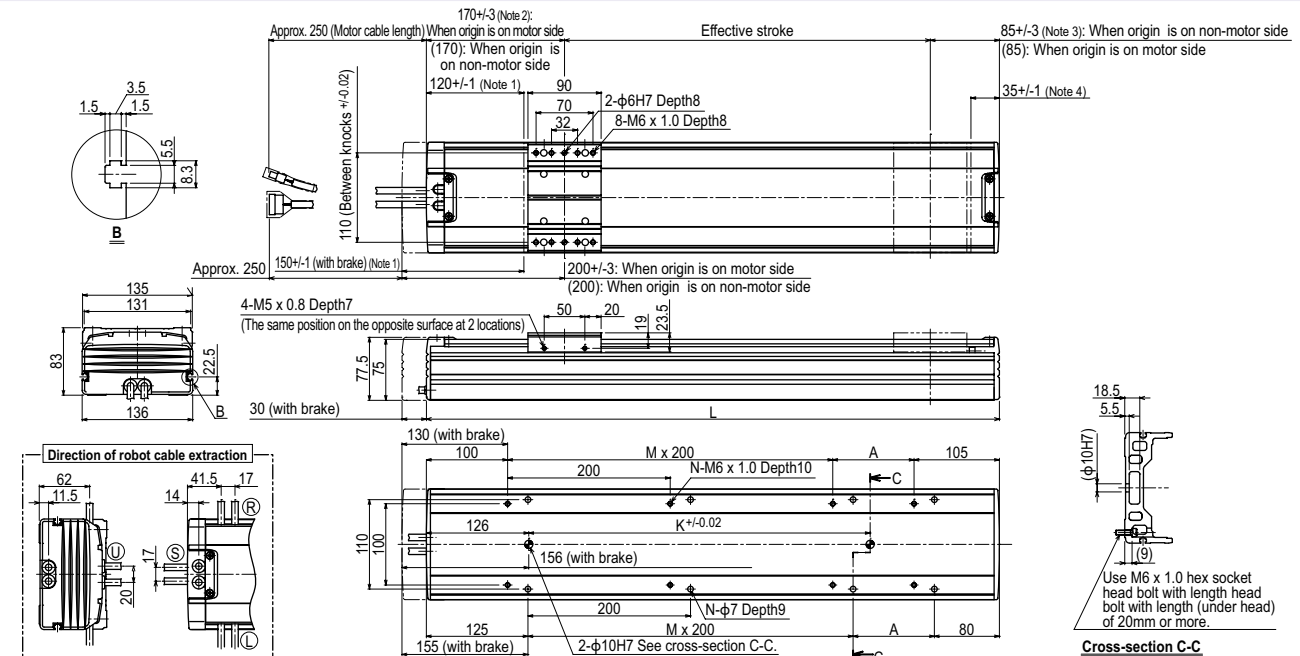

- Note 1. Stop positions are determined by the mechanical stoppers at both ends.  
 Note 2. 172.5+/-4 when the high lead specification (Lead 30) is used.  
 Note 3. 85+/-4 when the high lead specification (Lead 30) is used.  
 Note 4. 32.5+/-1 when the high lead specification (Lead 30) is used.  
 Note 5. Minimum bend radius of motor cable is R50.  
 Note 6. Weight of models with no brake. The weight of brake-attached models is 0.7 kg heavier than the models with no brake shown in the table.

Effective stroke	150	200	250	300	350	400	450	500	550	600	650	700	750	800	850	900	950	1000	1050	1100	1150	1200	1250	1305	1355	1405	1455	1505
	L	405	455	505	555	605	655	705	755	805	855	905	955	1005	1055	1105	1155	1205	1255	1305	1355	1405	1455	1505	1505	1505	1505	1505
A	200	50	100	150	200	50	100	150	200	50	100	150	200	50	100	150	200	50	100	150	200	50	100	150	200	50	100	150
M	0	1	1	1	1	2	2	2	2	3	3	3	3	3	4	4	4	4	5	5	5	5	5	5	5	5	5	5
N	4	6	6	6	6	8	8	8	8	10	10	10	10	12	12	12	12	14	14	14	14	14	14	14	14	16	16	16
K	240	240	240	240	420	420	420	420	600	600	600	600	780	780	780	780	960	960	960	960	960	960	960	960	1140	1140	1140	1140
Weight (kg)	6.2	6.9	7.5	8.2	8.8	9.5	10.1	10.8	11.4	12.1	12.6	13.4	13.9	14.6	15.2	15.9	16.5	17.2	17.8	18.5	19.1	19.8	20.4	20.4	20.4	20.4	20.4	20.4
Maximum speed (mm/sec)	Lead 30	1800	1200	600	300	-	-	-	-	-	-	-	-	1440	1170	900	810	600	540	480	390	300	270	240	195	150	135	135
Speed setting	Lead 20	80%	65%	50%	45%	-	-	-	-	-	-	-	-	80%	65%	50%	45%	-	-	-	-	-	-	-	-	-	-	-

Note 7. When the stroke is longer than 700mm, resonance of the ball screw may occur depending on the operation conditions (critical speed). In this case, reduce the speed setting on the program by referring to the maximum speeds shown in the table above.  
 Note 8. Strokes longer than 1050mm are special order items. Please contact us for speed setting.

# F14H

● High lead: Lead 30

● Origin on the non-motor side is selectable: Lead 10-20-30

Note. Strokes longer than 1050mm are special order items. Please consult us for delivery time.



## Ordering method

### F14H

Model	Lead designation	Brake	Cable entry location	Origin position change	Grease type	Stroke	Cable length
	30: 30mm 20: 20mm 10: 10mm 5: 5mm	No entry: No brakes BK: Brakes provided	No entry: Standard (S) U: From the top R: From the right L: From the left	None: Standard Z: Non-motor side	None: Standard GC: Clean	Lead 20-10-5: 150 to 1050 (50mm pitch) Lead 30: 150 to 1250 (50mm pitch)	3L: 3.5m 5L: 5m 10L: 10m 3K/5K/10K (Flexible cable)

- Note 1. The model with a lead of 30mm cannot select specifications with brake (vertical specifications).  
 Note 2. If selecting 5mm lead specifications then the origin point cannot be changed to the non-motor side.  
 Note 3. The robot cable is standard cable (3L/5L/10L), but can be changed to flexible cable. See P.596 for details on robot cable.  
 Note 4. See P.500 for DIN rail mounting bracket.  
 Note 5. Select this selection when using the gateway function. For details, see P.62.

### TSX

Positioner	Driver: Power-supply voltage	Regenerative unit	LCD monitor	I/O selection	Battery
TS-X	110: 100V/200V 210: 200V/200W	No entry: None R: With RGT	No entry: None L: With LCD	NP: NPN PN: PNP CC: CC-Link DN: DeviceNet™ EP: EtherNet/IP™ PT: PROFINET GW: No I/O board	B: With battery (Absolute) N: None (Incremental)

### SR1-X

Controller	Driver: Power capacity	Usable for CE	Regenerative unit	I/O selection	Battery
10	10: 200W	No entry: Standard E: CE marking	No entry: None R: With RGT	N: NPN P: PNP CC: CC-Link DN: DeviceNet™ PB: PROFINET	B: With battery (Absolute) N: None (Incremental)

### RDV-X

Driver	Power-supply voltage	Driver: Power capacity	Regenerative unit
2	2: AC200V	10: 200W or less	

## Specifications

AC servo motor output (W)	200
Repeatability (mm)	+/-0.01
Deceleration mechanism	Ball screw
Ball screw lead (mm)	30 20 10 5
Maximum speed (mm/sec)	1800 1200 600 300
Maximum payload (kg)	Horizontal: 25 40 80 100 Vertical: - 8 20 30
Rated thrust (N)	113 170 341 683
Stroke (mm)	150 to 1250 (50mm pitch)
Overall length (mm)	Horizontal: Stroke+320 Vertical: Stroke+350
Maximum dimensions of cross section of main unit (mm)	W136 x H83
Cable length (m)	Standard: 3.5 / Option: 5.10
Linear guide type	4 rows of circular arc grooves x 2 rail
Position detector	Resolvers
Resolution (Pulse/rotation)	16384

- Note 1. Positioning repeatability in one direction.  
 Note 2. When the stroke is longer than 700mm, resonance of the ball screw may occur depending on the operation conditions (critical speed). In this case, reduce the speed setting on the program by referring to the maximum speeds shown in the table below.  
 Note 3. Strokes longer than 1050mm are available only for high lead (Lead 30). (Special order item)  
 Note 4. Position detectors (resolvers) are common to incremental and absolute specifications. If the controller has a backup function then it will be absolute specifications.

## Allowable overhang

Lead	Horizontal installation (Unit: mm)			Wall installation (Unit: mm)			Vertical installation (Unit: mm)		
	A	B	C	A	B	C	A	C	
Lead 30	10kg: 2152	1673	934	10kg: 975	1219	1625	4kg: 2400	2016	
Lead 20	25kg: 1847	691	533	25kg: 482	426	1257	6kg: 1699	1364	
	10kg: 2265	1674	961	10kg: 999	1220	1711	8kg: 1301	1051	
Lead 10	20kg: 1402	855	537	20kg: 515	558	987	10kg: 1370	1106	
	40kg: 1047	445	324	40kg: 263	227	635	15kg: 906	732	
Lead 5	30kg: 1953	583	485	30kg: 419	338	1282	20kg: 678	548	
	50kg: 1655	365	328	50kg: 240	162	934	20kg: 767	619	
Lead 5	80kg: 1720	242	238	80kg: 134	62	756	25kg: 612	494	
	60kg: 2443	311	317	60kg: 209	117	1398	30kg: 503	407	
Lead 5	80kg: 2193	242	253	80kg: 135	62	1120			
	100kg: 2000	202	214	100kg: 90	29	900			

Note. Distance from center of slider top to center of gravity of object being carried at a guide service life of 10,000 km.

## Static loading moment

(Unit: N·m)		
MY	MP	MR
551	552	485

## Controller

Controller	Operation method
SR1-X10 RCX221/222 RCX240/340	Programming / I/O point trace / Remote command / Operation using RS-232C communication
TS-X110 TS-X210 RDV-X210-RBR1	I/O point trace / Remote command / Pulse train control

Note. When using the unit vertically, a regeneration unit is required.

## F14H

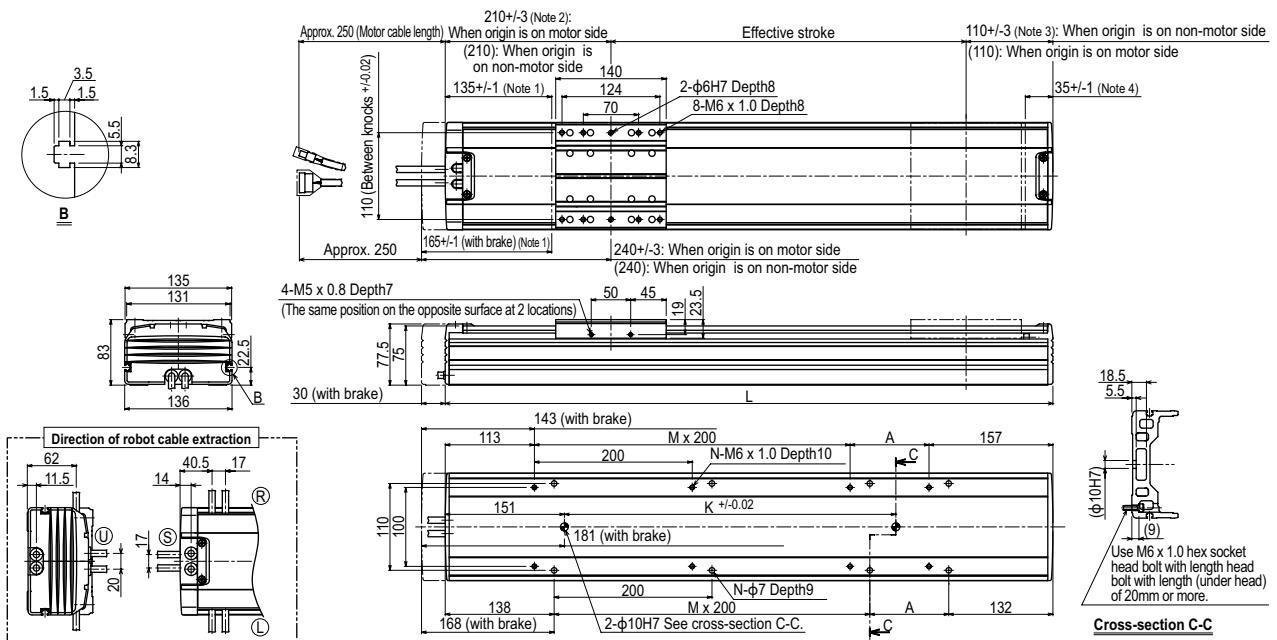

Note 1. Stop positions are determined by the mechanical stoppers at both ends.  
 Note 2. 212.5+/-4 when the high lead specification (Lead 30) is used.  
 Note 3. 110+/-4 when the high lead specification (Lead 30) is used.  
 Note 4. 32.5+/-1 when the high lead specification (Lead 30) is used.  
 Note 5. Minimum bend radius of motor cable is R50.  
 Note 6. Weight of models with no brake. The weight of brake-attached models is 0.7 kg heavier than the models with no brake shown in the table.

Effective stroke	150	200	250	300	350	400	450	500	550	600	650	700	750	800	850	900	950	1000	1050	1100	1150	1200	1250
L	470	520	570	620	670	720	770	820	870	920	970	1020	1070	1120	1170	1220	1270	1320	1370	1420	1470	1520	1570
A	200	50	100	150	200	50	100	150	200	50	100	150	200	50	100	150	200	50	100	150	200	50	100
M	0	1	1	1	1	2	2	2	2	3	3	3	3	4	4	4	4	5	5	5	5	6	6
N	4	6	6	6	6	8	8	8	8	10	10	10	10	12	12	12	12	14	14	14	14	16	16
K	240	240	240	420	420	420	600	600	600	600	600	780	780	960	960	960	960	960	1140	1140	1140	1140	1320
Weight (kg)	7.5	8.2	8.8	9.5	10.1	10.8	11.4	12.1	12.7	13.4	13.9	14.6	15.2	15.9	16.5	17.2	17.8	18.5	19.1	19.8	20.4	21.1	21.7
Lead 30	1800												1440	1170			900		810				
Lead 20		1200											960	780			600		540				
Lead 10			600										480	390			300		270				
Lead 5				300									240	195			150		135				
Speed setting													80%	65%			50%		45%				

- Note 7. When the stroke is longer than 700mm, resonance of the ball screw may occur depending on the operation conditions (critical speed). In this case, reduce the speed setting on the program by referring to the maximum speeds shown in the table above.  
 Note 8. Strokes longer than 1050mm are special order items. Please contact us for speed setting.

Controller

SR1-X ▶ 518

TS-X ▶ 492

RDV-X ▶ 506

# GF14XL

● Origin on the non-motor side is selectable

Note. If you need an installation posture other than the horizontal installation, please contact us.

## Ordering method

### GF14XL - S H - 20

Model	Model S: Straight model	Installation direction H: Horizontal installation	Lead designation	Cable entry location No entry: Standard (S) U: From the top R: From the right L: From the left	Origin position change None: Standard Z: Non-motor side	Frame No entry: Standard Spot facing T: Tapping	Grease type None: Standard GC: Clean	Stroke 750 to 2000 (50mm pitch)	Cable length <sup>Note 1</sup> 3L: 3.5m 5L: 5m 10L: 10m 3K/5K/10K (Flexible cable)
-------	-------------------------	---	------------------	--	---	--	--	------------------------------------	--

TSX	SR1-X	RDV-X	RBR1
Positioner <sup>Note 2</sup> TS-X	Controller 10: 200W	Driver 2: AC200V	Regenerative unit
Driver: Power-supply voltage Power capacity 110: 100V/200W 210: 200V/200W	Driver: Power capacity 10: 200W	Driver: Power-supply voltage 2: AC200V	Driver: Power capacity 20: 600W or less
LCD monitor No entry: None L: With LCD	Usable for CE No entry: Standard E: CE marking	Driver: Power capacity 20: 600W or less	Regenerative unit
I/O selection NP: NPN PN: PNP CC: CC-Link DN: DeviceNet™ EP: EtherNet/IP™ PT: PROFINET GW: No I/O board <sup>Note 3</sup>	I/O selection N: NPN P: PNP CC: CC-Link DN: DeviceNet™ PB: PROFIBUS	Driver: Power capacity 20: 600W or less	Regenerative unit
Battery B: With battery (Absolute) N: None (Incremental)	Battery B: With battery (Absolute) N: None (Incremental)	Driver: Power capacity 20: 600W or less	Regenerative unit

Note 1. The robot cable is standard cable (3L/5L/10L), but can be changed to flexible cable. See P.596 for details on robot cable.  
Note 2. See P.500 for DIN rail mounting bracket.  
Note 3. Select this selection when using the gateway function. For details, see P.62.

- [Cautions after purchase]
- When changing the origin position, contact us since the adjustment is needed.
  - When changing the cable entry location, contact us since necessary parts may vary depending on the cable entry location.
  - Do not install the robot with the horizontal installation specifications in a direction other than the horizontal direction.

## Specifications

AC servo motor output (W)	200
Repeatability <sup>Note 1</sup> (mm)	+/-0.01
Deceleration mechanism	Ball screw φ15
Ball screw lead (mm)	20
Maximum speed (mm/sec)	1200
Maximum payload (kg)	45
Rated thrust (N)	170
Stroke (mm)	750 to 2000 (50mm pitch)
Overall length (mm)	Stroke+561
Maximum dimensions of cross section of main unit (mm)	W140×H91.5
Cable length (m)	Standard: 3.5 / Option: 5.10
Linear guide type	4 rows of circular arc grooves × 2 rail
Position detector	Resolvers <sup>Note 2</sup>
Resolution (Pulse/rotation)	20480

Note 1. Positioning repeatability in one direction.  
Note 2. Position detectors (resolvers) are common to incremental and absolute specifications. If the controller has a backup function then it will be absolute specifications.

## Allowable overhang <sup>Note</sup>

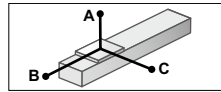

Horizontal installation (Unit: mm)	Horizontal installation (Unit: mm)		
	A	B	C
10kg	3550	1340	1210
20kg	2075	685	633
45kg	1280	326	308

Note. Distance from center of slider top to center of gravity of object being carried at a guide service life of 10,000 km.

Note. Service life is calculated for 1000mm stroke models.

## Static loading moment

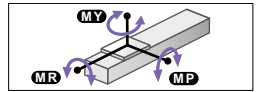

Static loading moment (Unit: N·m)		
MY	MP	MR
551	552	485

## Controller

Controller	Operation method
SR1-X10 RCX221/222 RCX240/340	Programming / I/O point trace / Remote command / Operation using RS-232C communication
TS-X110	I/O point trace / Remote command
TS-X210	I/O point trace / Remote command
RDV-X220-RBR1	Pulse train control

## GF14XL

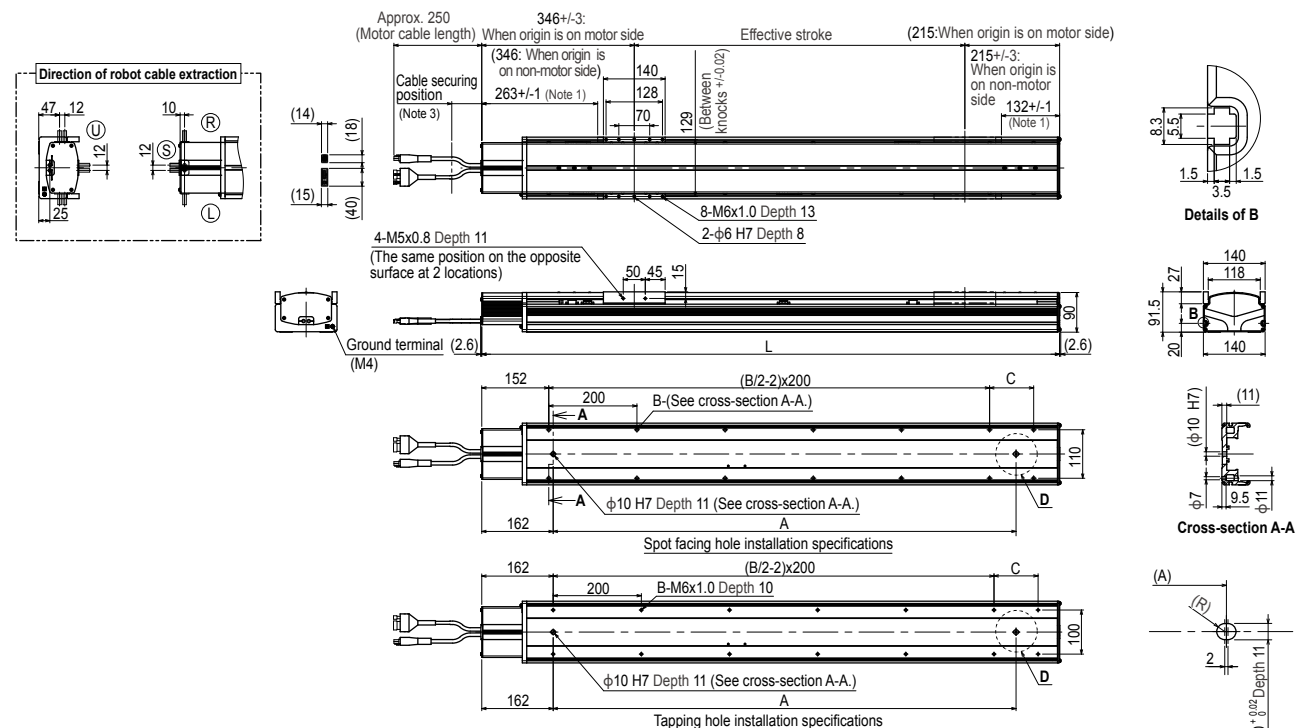

Note 1. Stop positions are determined by the mechanical stoppers at both ends.  
Note 2. When changing the return-to-origin direction, the adjustment is needed. (The standard is the origin on the motor side.)  
Note 3. Secure the cable with a tie-band 100mm or less from unit's end face to prevent the cable from being subjected to excessive loads.  
Note 4. The cable's minimum bend radius is R30.  
Note 5. The length under head of the hexagonal socket head bolts (M6 x 1.0) that are used to install the main body with the spot facing hole installation specifications is 20mm or more. It is recommended that the length under head of the hexagonal socket head bolts (M6 x 1.0) that are used to install the main body with the tapping hole installation specifications is the thickness of the installation base + 10mm or less.

Effective stroke	750	800	850	900	950	1000	1050	1100	1150	1200	1250	1300	1350	1400	1450	1500	1550	1600	1650	1700	1750	1800	1850	1900	1950	2000
L	1311	1361	1411	1461	1511	1561	1611	1661	1711	1761	1811	1861	1911	1961	2011	2061	2111	2161	2211	2261	2311	2361	2411	2461	2511	2561
A	1050	1100	1150	1200	1250	1300	1350	1400	1450	1500	1550	1600	1650	1700	1750	1800	1850	1900	1950	2000	2050	2100	2150	2200	2250	2300
B	14	14	14	16	16	16	16	18	18	18	18	20	20	20	20	22	22	22	22	24	24	24	24	26	26	26
C	100	150	200	50	100	150	200	50	100	150	200	50	100	150	200	50	100	150	200	50	100	150	200	50	100	150
Weight (kg)	22.5	23.2	23.8	24.5	25.2	25.9	26.5	27.2	27.9	28.6	29.2	29.9	30.6	31.3	31.9	32.6	33.3	33.9	34.6	35.3	36.0	36.6	37.3	38.0	38.7	39.3

# F17

- High lead: Lead 40
- Origin on the non-motor side is selectable

Note. Upper robot cable (U) on models with brakes is a special order item, so please consult our sales office or sales representative for assistance.  
(External dimensions: overall length + 20 mm)

## Ordering method

### F17

Model	Lead designation	Brake	Cable entry location	Origin position change	Grease type	Stroke	Cable length
	40: 40mm 20: 20mm 10: 10mm	No entry: No brakes BK: Brakes provided	No entry: Standard (S) U: From the top R: From the right L: From the left	None: Standard Z: Non-motor side	None: Standard GC: Clean	Lead 20-10: 200 to 1250 (50mm pitch) Lead 40: 200 to 1450 (50mm pitch)	3L: 3.5m 5L: 5m 10L: 10m 10L: 10m (Flexible cable)

TSX	220	SR1-X	20	RDV-X	2	20
Positioner TS-X	Driver: Power-supply voltage Power capacity 220: 200V/400 to 600W	Controller	Driver: Power capacity 20: 400 to 600W	Driver	Power-supply voltage 2: AC200V	Driver: Power capacity 20: 600W or less
	Regenerative unit No entry: None R: With RGT	Usable for CE No entry: Standard E: CE marking	Regenerative unit No entry: None R: With RG1			Regenerative unit RBR1 (Horizontal) RBR2 (Vertical)
	LCD monitor No entry: None L: With LCD					
	I/O selection NP: NPN PN: PNP CC: CC-Link DN: DeviceNet™ EP: EtherNet/IP™ PT: PROFINET GW: No I/O board		I/O selection N: NPN P: PNP CC: CC-Link DN: DeviceNet™ PB: PROFIBUS			
	Battery N: None (Incremental)		Battery B: With battery (Absolute) N: None (Incremental)			

- Note 1. The model with a lead of 40mm cannot select specifications with brake (vertical specifications).  
Note 2. Upper robot cable (U) on models equipped with brake is a special-order item.  
Note 3. The robot cable is standard cable (3L/5L/10L), but can be changed to flexible cable. See P.596 for details on robot cable.  
Note 4. See P.500 for DIN rail mounting bracket.  
Note 5. The robot with the high lead specifications (lead 40) needs a regenerative unit.  
Note 6. Select this selection when using the gateway function. For details, see P.62.

## Specifications

AC servo motor output (W)	400
Repeatability (mm)	+/-0.01
Deceleration mechanism	Ball screw
Ball screw lead (mm)	40 20 10
Maximum speed (mm/sec)	2400 1000 (1200) 600
Maximum payload (kg)	Horizontal 40 80 120 Vertical - 15 35
Rated thrust (N)	169 339 678
Stroke (mm)	200 to 1450 (50mm pitch)
Overall length (mm)	Horizontal Stroke+375 Stroke+365 Vertical - Stroke+395
Maximum dimensions of cross section of main unit (mm)	W168 x H100
Cable length (m)	Standard: 3.5 / Option: 5.10
Linear guide type	4 rows of circular arc grooves x 2 rail
Position detector	Resolvers
Resolution (Pulse/rotation)	16384

- Note 1. Repeatability for single oscillation.  
Note 2. When the stroke exceeds 800mm, although depending on the moving range, the ball screw may resonate (critical speed). In that case, make adjustment to lower the speed on the program using the maximum speed given in the below table as a guide.  
Note 3. To operate the unit at a speed exceeding 1,000mm/sec. (Max. speed), a regeneration unit RG1 is required.  
Note 4. Longer than 1250mm stroke can be handled by the high lead specification (Lead 40) only.  
Note 5. Position detectors (resolvers) are common to incremental and absolute specifications. If the controller has a backup function then it will be absolute specifications.

## Allowable overhang

Horizontal installation (Unit: mm)	Lead 40			Lead 20			Lead 10				
	A	B	C	A	B	C	A	B	C		
10kg	3540	2753	1999	10kg	2022	2670	3501	10kg	2022	2670	3501
20kg	2541	1357	1181	20kg	1202	1283	2483	20kg	1202	1283	2483
40kg	2639	661	736	40kg	752	587	2516	40kg	752	587	2516
30kg	2647	894	989	30kg	987	820	2678	30kg	987	820	2678
50kg	1770	521	588	50kg	574	447	1685	50kg	574	447	1685
80kg	1391	312	362	80kg	342	237	1263	80kg	342	237	1263
60kg	2443	430	572	60kg	535	355	2443	60kg	535	355	2443
100kg	2000	243	326	100kg	283	169	2000	100kg	283	169	2000
120kg	1841	197	264	120kg	220	123	1841	120kg	220	123	1841

Note. Distance from center of slider top to center of gravity of object being carried at a guide service life of 10,000 km.

## Static loading moment

Static loading moment (Unit: N·m)		
MY	MP	MR
1032	1034	908

## Controller

Controller	Operation method
SR1-X20	Programming / I/O point trace / Remote command / Operation using RS-232C communication
RCX221/222, RCX240/340	Operation using RS-232C communication
TS-X220	I/O point trace / Remote command
RDV-X220-RBR1 (Horizontal)	Pulse train control
RDV-X220-RBR2 (Vertical)	

- Note. [The following arrangements require a regeneration unit.]  
 • Using in the upright position.  
 • To move at a speed exceeding 1,000 mm/sec horizontally.  
 • High lead (40) used horizontally.

## F17

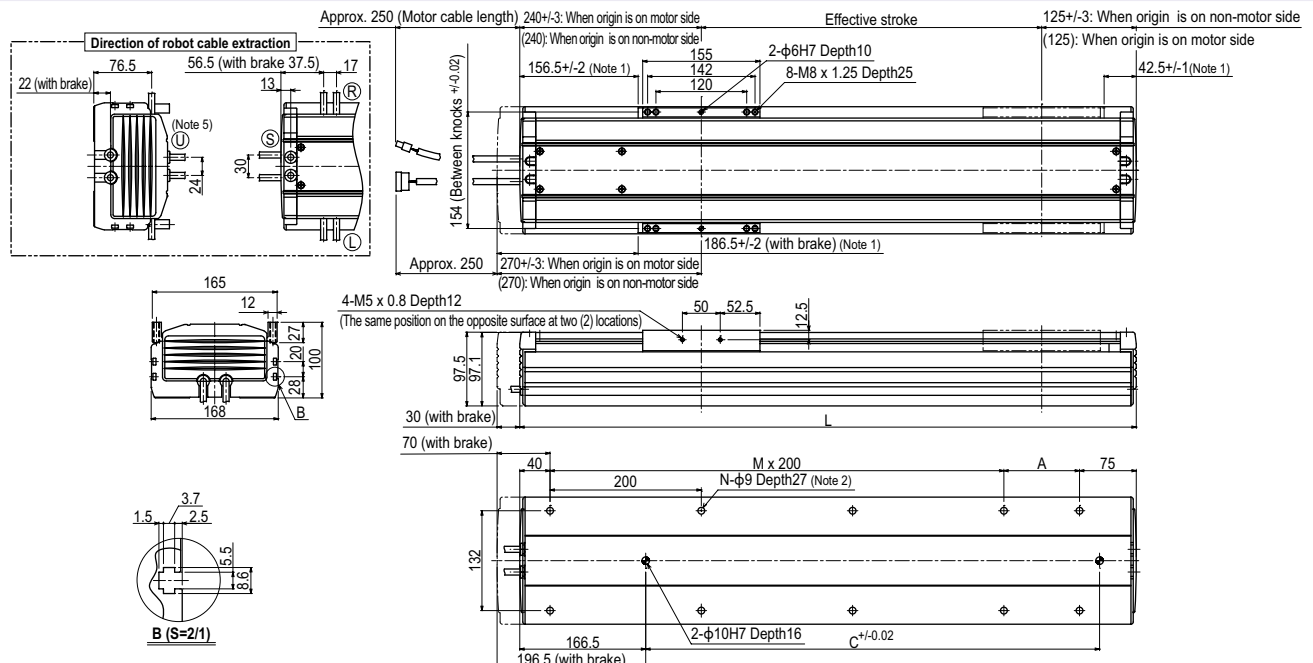

- Note 1. Stop positions are determined by the mechanical stoppers at both ends.  
 Note 2. When installing the robot, do not use washers inside the robot body.  
 Note 3. Minimum bend radius of motor cable is R50.  
 Note 4. Weight of models with no brake. The weight of brake-attached models is 1.2 kg heavier than the models with no brake shown in the table.  
 Note 5. Make a separate consultation with us regarding robot cable (brake specifications) U extraction. (External dimensions: overall length + 20 mm)  
 Note 6. When the stroke is longer than 800mm, resonance of the ball screw may occur depending on the operation conditions (critical speed). In this case, reduce the speed setting on the program by referring to the maximum speeds shown in the table above.  
 Note 7. To operate the unit at a speed exceeding 1,000mm/sec. (Max. speed), a regeneration unit RG1 is required.

Effective stroke	200	250	300	350	400	450	500	550	600	650	700	750	800	850	900	950	1000	1050	1100	1150	1200	1250	
L	565	615	665	715	765	815	865	915	965	1015	1065	1115	1165	1215	1265	1315	1365	1415	1465	1515	1565	1615	
A	50	100	150	200	50	100	150	200	50	100	150	200	50	100	150	200	50	100	150	200	50	100	
M	2	2	2	2	3	3	3	3	4	4	4	4	5	5	5	5	6	6	6	6	7	7	
N	8	8	8	8	10	10	10	10	12	12	12	12	14	14	14	16	16	16	16	16	18	18	
C	240	240	420	420	420	600	600	600	600	780	780	780	780	960	960	960	960	1140	1140	1140	1140	1320	
Weight (kg)	14.5	15.3	16.2	17.0	17.8	18.6	19.5	20.3	21.1	21.9	22.8	23.6	24.4	25.2	26.1	26.9	27.7	28.5	29.4	30.2	31.0	31.8	
Maximum speed (mm/sec)	1000 (1200)											960	840	720	600	480	420	360	300	240	200	180	
Speed setting	-											80%	70%	60%	50%	40%	30%	20%	10%	5%	5%	5%	5%

- Articulated robots  
YA
- Linear conveyor modules  
LCM100
- Compact single-axis robots  
TRANSEVO
- Single-axis robots  
FLIP-X
- Linear motor single-axis robots  
PHASER
- Cartesian robots  
XY-X
- SCARA robots  
YK-X
- Pick & place robots  
YP-X
- CLEAN CONTROLLER INFORMATION
- T type
- F type
- GF type
- N type
- B/R type

## F17 High lead type: Lead 40

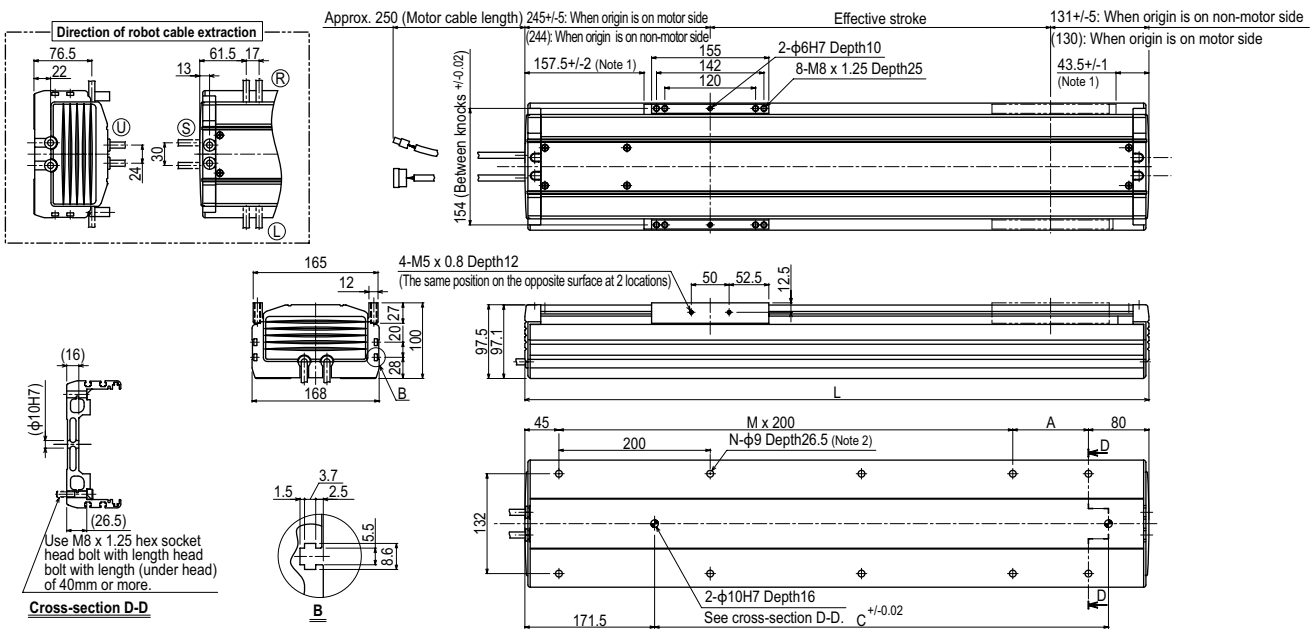

Note 1. Stop positions are determined by the mechanical stoppers at both ends.  
Note 2. When installing the robot, do not use washers inside the robot body.

Note 3. Minimum bend radius of motor cable is R50.

Effective stroke	200	250	300	350	400	450	500	550	600	650	700	750	800	850	900	950	1000	1050	1100	1150	1200	1250	1300	1350	1400	1450				
L	575	625	675	725	775	825	875	925	975	1025	1075	1125	1175	1225	1275	1325	1375	1425	1475	1525	1575	1625	1675	1725	1775	1825				
A	50	100	150	200	50	100	150	200	50	100	150	200	50	100	150	200	50	100	150	200	50	100	150	200	50	100				
M	2	2	2	2	3	3	3	3	4	4	4	4	5	5	5	5	6	6	6	6	7	7	7	7	8	8				
N	8	8	8	8	10	10	10	10	12	12	12	12	14	14	14	14	16	16	16	16	18	18	18	18	20	20				
C	240	240	420	420	420	600	600	600	600	780	780	780	780	960	960	960	960	1140	1140	1140	1140	1320	1320	1320	1320	1320				
Weight (kg)	14.7	15.5	16.4	17.2	18.0	18.8	19.7	20.5	21.3	22.1	23.0	23.8	24.6	25.4	26.3	27.1	27.9	28.7	29.6	30.4	31.2	32.0	32.8	33.6	34.4	35.2				
Maximum speed <sup>Note 4</sup> (mm/sec)	Lead 40														2400		1920		1680		1440		1200		960		840		720	
Speed setting	-														-		80%		70%		60%		50%		40%		35%		30%	

Note 4. When the stroke is longer than 800mm, resonance of the ball screw may occur depending on the operation conditions (critical speed). In this case, reduce the speed setting on the program by referring to the maximum speeds shown in the table above.



# F17L

● Origin on the non-motor side is selectable

Note. Upper robot cable (U) on models with brakes is a special order item, so please consult our sales office or sales representative for assistance. (External dimensions: overall length + 20 mm)

## Ordering method

### F17L-50

Model	Lead designation	Brake	Cable entry location	Origin position change	Grease type	Stroke	Cable length <sup>Note 1</sup>
		No entry: No brakes BK: Brakes provided	No entry: Standard (S) U: From the top <sup>Note 1</sup> R: From the right L: From the left	None: Standard Z: Non-motor side	None: Standard GC: Clean	1100 to 2050 (50mm pitch)	3L: 3.5m 5L: 5m 10L: 10m 3K/5K/10K (Flexible cable)

TSX	220	R	I/O selection	Battery	
Positioner <sup>Note 1</sup> TS-X	Driver: Power supply voltage / Power capacity <sup>Note 4</sup> 220: 200V/400 to 600W	Regenerative unit R: With RGT	LCD monitor No entry: None L: With LCD	N: NPN P: PNP CC: CC-Link DN: DeviceNet™ EP: EtherNet/IP™ PT: PROFIBUS GW: No I/O board <sup>Note 5</sup>	B: With battery (Absolute) N: None (Incremental)
SR1-X	20	R	I/O selection	Battery	
Controller	Driver: Power capacity <sup>Note 4</sup> 20: 400 to 600W	Usable for CE No entry: Standard E: CE marking	Regenerative unit R: With RGT1	N: NPN P: PNP CC: CC-Link DN: DeviceNet™ PB: PROFIBUS	B: With battery (Absolute) N: None (Incremental)
RDV-X	2	20	Regenerative unit	Battery	
Driver	Power supply voltage 2: AC200V	Driver: Power capacity <sup>Note 4</sup> 20: 600W or less	RBR1 (Horizontal) RBR2 (Vertical)		

- Note 1. Upper robot cable (U) on models equipped with brake is a special-order item.  
 Note 2. The robot cable is standard cable (3L/5L/10L), but can be changed to flexible cable. See P.596 for details on robot cable.  
 Note 3. See P.500 for DIN rail mounting bracket.  
 Note 4. Acceleration / deceleration is different depending the Positioner or Controller or Driver.  
 Note 5. Select this selection when using the gateway function. For details, see P.62.

## Specifications

AC servo motor output (W)	600
Repeatability <sup>Note 1</sup> (mm)	+/-0.02
Deceleration mechanism	Ball screw
Ball screw lead (mm)	50
Maximum speed <sup>Note 2</sup> (mm/sec)	2200
Maximum payload (kg)	Horizontal: 50 Vertical: 10
Rated thrust (N)	204
Stroke (mm)	1100 to 2050 (50mm pitch)
Overall length (mm)	Horizontal: Stroke+475 Vertical: Stroke+505
Maximum dimensions of cross section of main unit (mm)	W168 × H100
Cable length (m)	Standard: 3.5 / Option: 5.10
Linear guide type	4 rows of circular arc grooves × 2 rail
Position detector	Resolvers <sup>Note 3</sup>
Resolution (Pulse/rotation)	16384

- Note 1. Positioning repeatability in one direction.  
 Note 2. When the stroke is longer than 1200mm, resonance of the ball screw may occur depending on the operation conditions (critical speed). In this case, reduce the speed setting on the program by referring to the maximum speeds shown in the table below.  
 Note 3. Position detectors (resolvers) are common to incremental and absolute specifications. If the controller has a backup function then it will be absolute specifications.

## Allowable overhang <sup>Note</sup>

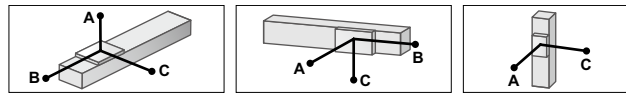

Lead 50	Horizontal installation (Unit: mm)			Wall installation (Unit: mm)			Vertical installation (Unit: mm)		
	A	B	C	A	B	C	A	B	C
10kg	4000	2755	2608	2720	2681	4000	2kg	1200	1200
30kg	3045	895	1175	1185	821	3045	5kg	3000	3000
50kg	2602	523	715	680	449	2602	10kg	2650	2650

Note. Distance from center of slider top to center of gravity of object being carried at a guide service life of 10,000 km.

## Static loading moment

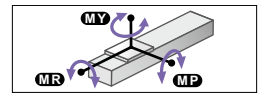

			(Unit: N·m)		
MY	MP	MR	MY	MP	MR
1032	1034	908			

## Controller

Controller	Operation method
SR1-X20-R RCX221/222 RCX240/340	Programming / I/O point trace / Remote command / Operation using RS-232C communication
TS-X220-R RDV-X220-RBR1 (Horizontal) RDV-X220-RBR2 (Vertical)	I/O point trace / Remote command Pulse train control

## F17L

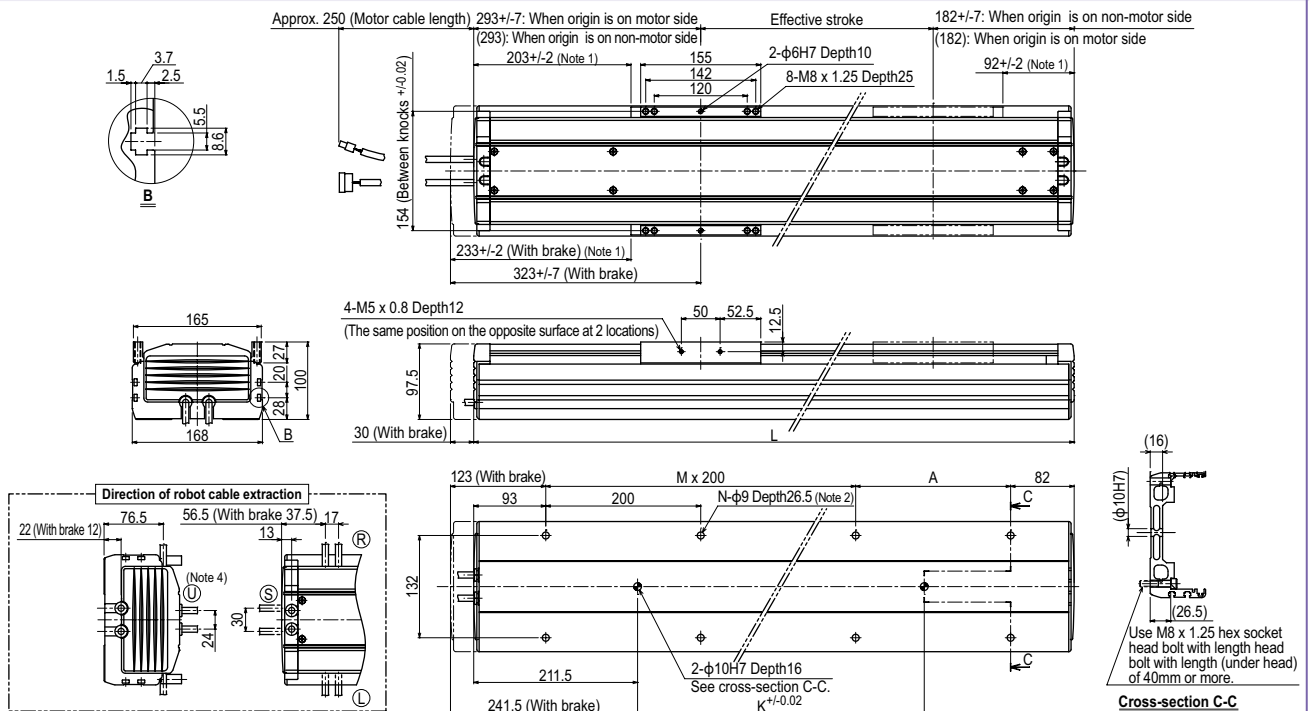

- Note 1. Stop positions are determined by the mechanical stoppers at both ends.  
 Note 2. It is not allowed to use a counter bore washer, etc. when installing the main unit.  
 Note 3. This is the weight of the model without a brake. The weight of the model equipped with a brake is 1.2kg heavier than this value.  
 Note 4. Make a separate consultation with us regarding robot cable (brake specifications) U extraction. (External dimensions: overall length + 20 mm)

Effective stroke	1100	1150	1200	1250	1300	1350	1400	1450	1500	1550	1600	1650	1700	1750	1800	1850	1900	1950	2000	2050
L	1575	1625	1675	1725	1775	1825	1875	1925	1975	2025	2075	2125	2175	2225	2275	2325	2375	2425	2475	2525
A	200	50	100	150	200	50	100	150	200	50	100	150	200	50	100	150	200	50	100	150
M	6	7	7	7	7	8	8	8	8	9	9	9	9	10	10	10	10	11	11	11
N	16	18	18	18	18	20	20	20	20	22	22	22	22	24	24	24	24	26	26	26
K	1140	1140	1320	1320	1320	1320	1320	1320	1320	1320	1320	1320	1320	1320	1320	1320	1320	1320	1320	1320
Weight (kg) <sup>Note 3</sup>	34.1	34.9	35.8	36.7	37.6	38.4	39.3	40.2	41.1	42	42.9	43.8	44.7	45.6	46.5	47.3	48.2	49.1	50	50.9
Maximum speed <sup>Note 5</sup>	2200				1900				1500				1200				900		800	
(mm/sec)	Speed setting				86%				68%				54%				40%		36%	

Note 5. When the stroke exceeds 1200mm, although depending on the moving range, the ball screw may resonate (critical speed). In that case, make adjustment to lower the speed on the program using the maximum speed given in the above table as a guide.

Controller

**SR1-X ▶ 518 TS-X ▶ 492 RDV-X ▶ 506**

# GF17XL

Origin on the non-motor side is selectable

Note. If you need an installation posture other than the horizontal installation, please contact us.

## Ordering method

### GF17XL - S H - 20

Model	Model	Installation direction	Lead designation	Cable entry location	Origin position change	Frame	Grease type	Stroke	Cable length
S: Straight model	H: Horizontal installation	No entry: Standard (S) U: From the top R: From the right L: From the left	None: Standard Z: Non-motor side	No entry: Standard (Spot facing) T: Tapping	None: Standard GC: Clean	850 to 2500 (50mm pitch)	3L: 3.5m 5L: 5m 10L: 10m 3K/5K/10K (Flexible cable)		

<b>TSX</b> Positioner 220 Driver: Power-supply voltage / Power capacity 220: 200V/400 to 600W	Regenerative unit No entry: None R: With RGT	LCD monitor No entry: None L: With LCD	I/O selection N: PNP P: PNP CC: CC-Link DN: DeviceNet™ EP: EtherNet/IP™ PT: PROFINET GW: No I/O board	Battery B: With battery (Absolute) N: None (Incremental)
<b>SR1-X</b> Controller 20 Driver: Power capacity 20: 400 to 600W	Usable for CE marking No entry: Standard E: CE marking R: With RGT	Regenerative unit No entry: None R: With RGT	I/O selection N: NPN P: PNP CC: CC-Link DN: DeviceNet™ EP: EtherNet/IP™ PB: PROFIBUS	Battery B: With battery (Absolute) N: None (Incremental)
<b>RDV-X</b> Driver 2 Power-supply voltage 2: AC200V	20 Driver: Power capacity 20: 600W or less	RBR1 Regenerative unit		

- Note 1. The robot cable is standard cable (3L/5L/10L), but can be changed to flexible cable. See P.596 for details on robot cable.  
 Note 2. See P.500 for DIN rail mounting bracket.  
 Note 3. Select this selection when using the gateway function. For details, see P.62.  
 Note 4. When operating the robot at a speed that is a maximum speed of 750 mm/sec or less, the regenerative unit is not needed.

- [Cautions after purchase]  
 • When changing the origin position, contact us since the adjustment is needed.  
 • When changing the cable entry location, contact us since necessary parts may vary depending on the cable entry location.  
 • Do not install the robot with the horizontal installation specifications in a direction other than the horizontal direction.

## Specifications

AC servo motor output (W)	400
Repeatability <sup>Note 1</sup> (mm)	+/-0.01
Deceleration mechanism	Ball screw φ20
Ball screw lead (mm)	20
Maximum speed (mm/sec)	1200 <sup>Note 2</sup>
Maximum payload (kg)	90
Rated thrust (N)	339
Stroke (mm)	850 to 2500 (50mm pitch)
Overall length (mm)	Stroke+686
Maximum dimensions of cross section of main unit (mm)	W168×H105.5
Cable length (m)	Standard: 3.5 / Option: 5.10
Linear guide type	4 rows of circular arc grooves × 2 rail
Position detector	Resolvers <sup>Note 3</sup>
Resolution (Pulse/rotation)	20480

## Allowable overhang<sup>Note</sup>

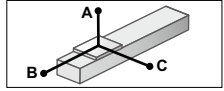

Horizontal installation (Unit: mm)	A	B	C	
	30kg	4050	1090	1405
Lead 20	50kg	2755	650	835
	90kg	1610	345	450

Note. Distance from center of slider top to center of gravity of object being carried at a guide service life of 10,000 km.  
 Note. Service life is calculated for 1000mm stroke models.

## Static loading moment

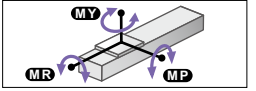

(Unit: N·m)		
MY	MP	MR
1032	1034	908

## Controller

Controller	Operation method
SR1-X20 <sup>Note</sup> RCX221/222 RCX240/340	Programming / I/O point trace / Remote command / Operation using RS-232C communication
TS-X220	I/O point trace / Remote command
RDV-X220-RBR1	Pulse train control

Note. To operate the unit at a speed exceeding 750 mm/sec. (Max. speed), a regeneration unit is required.

## GF17XL

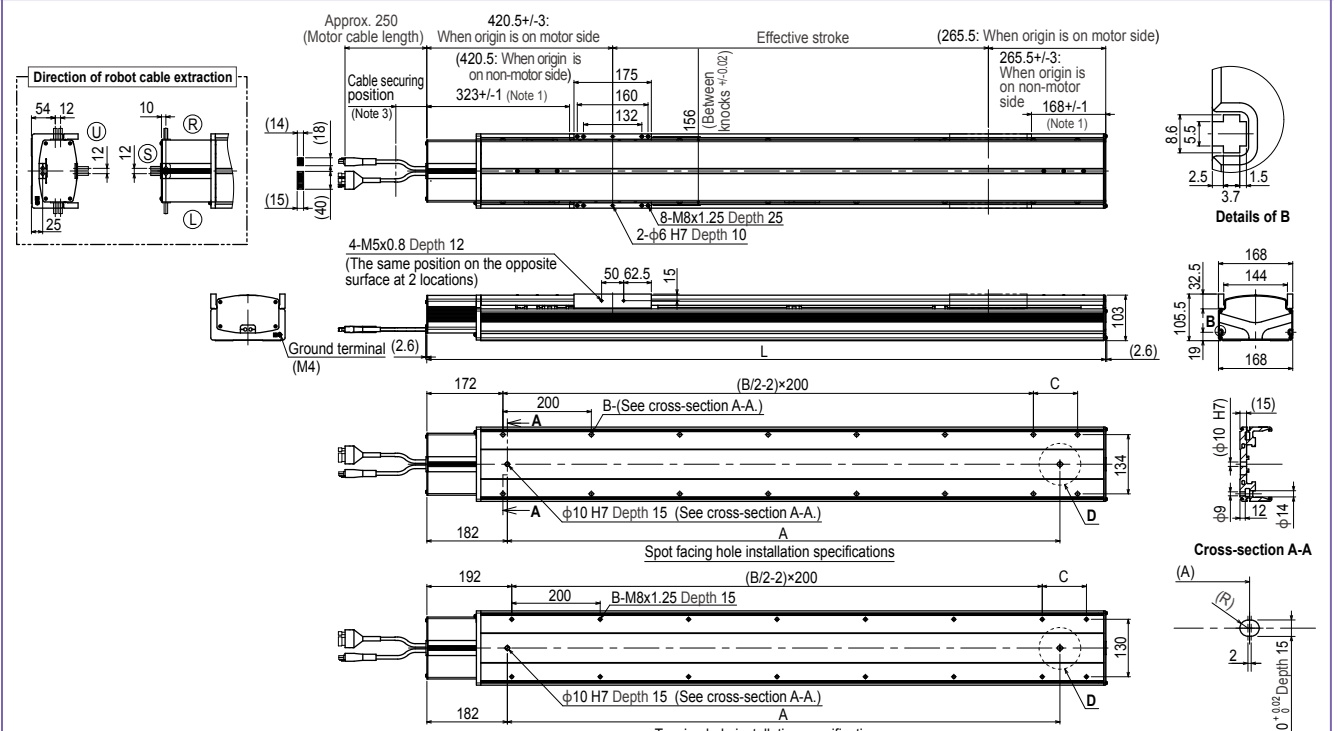

- Note 1. Stop positions are determined by the mechanical stoppers at both ends.  
 Note 2. When changing the return-to-origin direction, the adjustment is needed. (The standard is the origin on the motor side.)  
 Note 3. Secure the cable with a tie-band 100mm or less from unit's end face to prevent the cable from being subjected to excessive loads.  
 Note 4. The cable's minimum bend radius is R30.  
 Note 5. The length under head of the hexagonal socket head bolts (M8 x 1.25) that are used to install the main body with the spot facing hole installation specifications is 45 mm or more. It is recommended that the length under head of the hexagonal socket head bolts (M8 x 1.25) that are used to install the main body with the tapping hole installation specifications is the thickness of the installation base + 15 mm or less.

Effective stroke	850	900	950	1000	1050	1100	1150	1200	1250	1300	1350	1400	1450	1500	1550	1600	1650	1700	1750	1800	1850	1900	1950	2000	2050	2100	2150	2200	2250	2300	2350	2400	2450	2500
L	1536	1586	1636	1686	1736	1786	1836	1886	1936	1986	2036	2086	2136	2186	2236	2286	2336	2386	2436	2486	2536	2586	2636	2686	2736	2786	2836	2886	2936	2986	3036	3086	3136	3186
A	1250	1300	1350	1400	1450	1500	1550	1600	1650	1700	1750	1800	1850	1900	1950	2000	2050	2100	2150	2200	2250	2300	2350	2400	2450	2500	2550	2600	2650	2700	2750	2800	2850	2900
B	16	16	16	18	18	18	18	20	20	20	20	22	22	22	22	24	24	24	24	26	26	26	26	28	28	28	28	30	30	30	30	32	32	32
C	100	150	200	50	100	150	200	50	100	150	200	50	100	150	200	50	100	150	200	50	100	150	200	50	100	150	200	50	100	150	200	50	100	150
Weight (kg)	37.4	38.4	39.4	40.3	41.3	42.3	43.2	44.2	45.2	46.1	47.1	48.1	49.0	50.0	51.0	51.9	52.9	53.9	54.8	55.8	56.8	57.7	58.7	59.7	60.6	61.6	62.6	63.5	64.5	65.5	66.4	67.4	68.4	69.3

# F20

- High lead: Lead 40
- Origin on the non-motor side is selectable

Note. Upper robot cable (U) on models with brakes is a special order item, so please consult our sales office or sales representative for assistance. (External dimensions: overall length + 20 mm)

## Ordering method

### F20

Model	Lead designation	Brake	Cable entry location	Origin position change	Grease type	Stroke	Cable length
	40: 40mm 20: 20mm 10: 10mm	No entry: BK: Brakes provided	No entry: Standard (S) U: From the top R: From the right L: From the left	None: Standard Z: Non-motor side	None: Standard GC: Clean	Lead 20-10: 200 to 1250 (50mm pitch) Lead 40: 200 to 1450 (50mm pitch)	3L: 3.5m 5L: 5m 10L: 10m 3K/5K/10K (Flexible cable)

- Note 1. The model with a lead of 10mm cannot select specifications without brake (horizontal specifications).  
The model with a lead of 40mm cannot select specifications with brake (vertical specifications).  
Note 2. Upper robot cable (U) on models equipped with brake is a special-order item.  
Note 3. The robot cable is standard cable (3L/5L/10L), but can be changed to flexible cable. See P.596 for details on robot cable.  
Note 4. See P.500 for DIN rail mounting bracket.  
Note 5. Acceleration / deceleration is different depending the Positioner or Controller or Driver.  
Note 6. The robot with the high lead specifications (lead 40) needs a regenerative unit.  
Note 7. Select this selection when using the gateway function. For details, see P.62.

TSX	220			
Positioner TS-X	Driver: Power supply voltage Power capacity 220: 200V/400 to 600W	Regenerative unit No entry: None R: With RGT	LCD monitor No entry: None L: With LCD	I/O selection NP: NPN PN: PNP CC: CC-Link DN: DeviceNet™ EP: EtherNet/IP™ PT: PROFINET GW: No I/O board
SR1-X	20			
Controller	Driver: Power capacity 20: 400 to 600W	Usable for CE No entry: Standard E: CE marking	Regenerative unit No entry: None R: With RG1	I/O selection N: NPN P: PNP CC: CC-Link DN: DeviceNet™ PB: PROFIBUS
RDV-X	2	20		
Driver	Power supply voltage 2: AC200V	Driver: Power capacity 20: 600W or less	Regenerative unit RBR1 (Horizontal) RBR2 (Vertical)	Battery B: With battery (Absolute) N: None (Incremental)

## Specifications

AC servo motor output (W)	600		
Repeatability (mm)	+/-0.01		
Deceleration mechanism	Ball screw		
Ball screw lead (mm)	40	20	10
Maximum speed (mm/sec)	2400	1000 (1200)	600
Maximum payload (kg)	Horizontal 60	Vertical 120	45
Rated thrust (N)	255	510	1020
Stroke (mm)	200 to 1450 (50mm pitch)		
Overall length (mm)	Horizontal Stroke+427	Vertical Stroke+417	-
Maximum dimensions of cross section of main unit (mm)	W202 x H115		
Cable length (m)	Standard: 3.5 / Option: 5.10		
Linear guide type	4 rows of circular arc grooves x 2 rail		
Position detector	Resolvers		
Resolution (Pulse/rotation)	16384		

- Note 1. Positioning repeatability in one direction.  
Note 2. When the stroke is longer than 800mm, resonance of the ball screw may occur depending on the operation conditions (critical speed). In this case, reduce the speed setting on the program by referring to the maximum speeds shown in the table below.  
Note 3. To operate the unit at a speed exceeding 1,000mm/sec. (Max. speed), a regeneration unit RG1 is required.  
Note 4. Longer than 1250mm stroke can be handled by the high lead specification (Lead 40) only.  
Note 5. Position detectors (resolvers) are common to incremental and absolute specifications. If the controller has a backup function then it will be absolute specifications.

## Allowable overhang

Horizontal installation	(Unit: mm)		
	A	B	C
Lead 40	10kg 4000	20kg 4000	30kg 3450
Lead 20	10kg 3397	20kg 2235	30kg 2073
Lead 10	60kg 2443	718	977
Lead 20	50kg 2602	869	1083
Lead 10	80kg 2193	528	703
Lead 20	120kg 1841	339	505
Wall installation	(Unit: mm)		
	A	B	C
Lead 40	10kg 3571	4000	4000
Lead 20	20kg 2118	2164	3397
Lead 10	60kg 1000	648	2443
Lead 20	50kg 1097	799	2602
Lead 10	80kg 708	458	2193
Lead 20	120kg 468	268	1841
Vertical installation	(Unit: mm)		
	A	C	
Lead 20	15kg 2635	2635	
Lead 10	20kg 2000	2000	
Lead 20	25kg 1621	1621	
Lead 10	20kg 2188	2188	
Lead 20	30kg 1446	1446	
Lead 10	45kg 951	951	

Note. Distance from center of slider top to center of gravity of object being carried at a guide service life of 10,000 km.

## Static loading moment

(Unit: N·m)		
MY	MP	MR
1196	1199	1052

## Controller

Controller	Operation method
SR1-X20	Programming / I/O point trace / Remote command / Operation using RS-232C communication
RCX221/222, RCX240/340	Operation using RS-232C communication
TS-X220	I/O point trace / Remote command
RDV-X220-RBR1 (Horizontal)	Pulse train control
RDV-X220-RBR2 (Vertical)	

- Note. [The following arrangements require a regeneration unit.]  
 • Using in the upright position.  
 • To move at a speed exceeding 1,000 mm/sec horizontally.  
 • High lead (40) used horizontally.

## F20

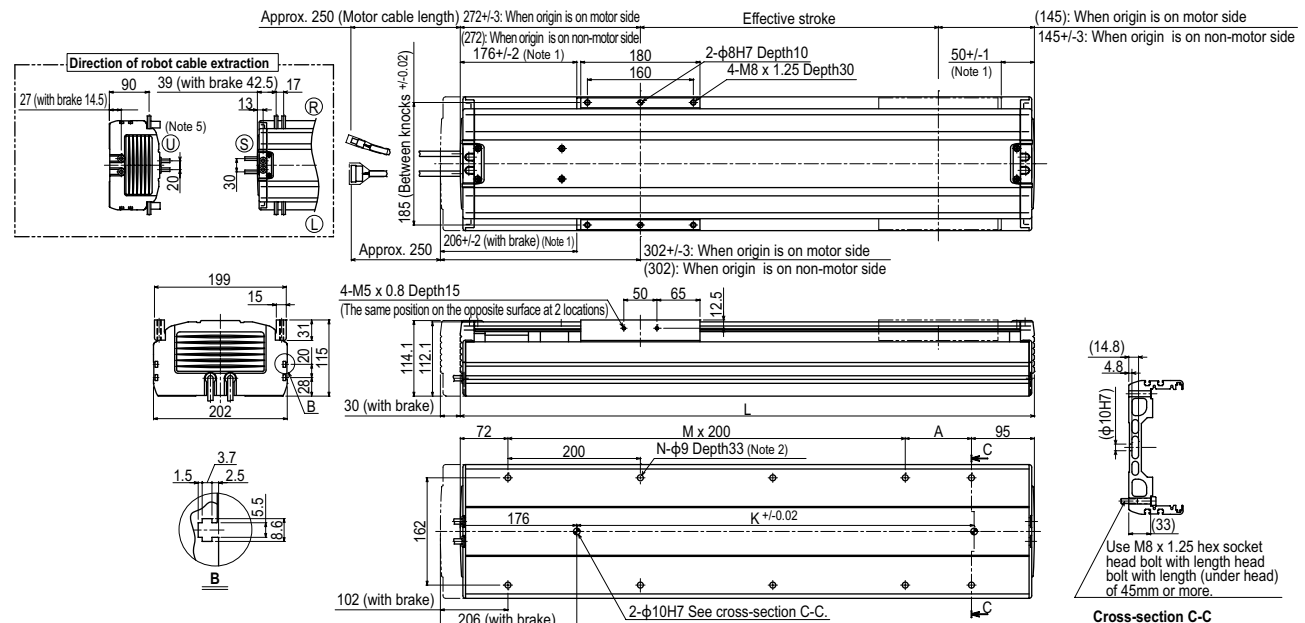

- Note 1. Stop positions are determined by the mechanical stoppers at both ends.  
 Note 2. When installing the robot, do not use washers inside the robot body.  
 Note 3. Minimum bend radius of motor cable is R50.  
 Note 4. Weight of models with no brake. The weight of brake-attached models is 1.5 kg heavier than the models with no brake shown in the table.  
 Note 5. Make a separate consultation with us regarding robot cable (brake specifications) U extraction. (External dimensions: overall length + 20 mm)

Effective stroke	200	250	300	350	400	450	500	550	600	650	700	750	800	850	900	950	1000	1050	1100	1150	1200	1250	
L	617	667	717	767	817	867	917	967	1017	1067	1117	1167	1217	1267	1317	1367	1417	1467	1517	1567	1617	1667	
A	50	100	150	200	50	100	150	200	50	100	150	200	50	100	150	200	50	100	150	200	50	100	
M	2	2	2	2	3	3	3	3	4	4	4	5	5	5	5	6	6	6	6	6	7	7	
N	8	8	8	8	10	10	10	10	12	12	12	14	14	14	14	16	16	16	16	16	18	18	
K	420	420	420	420	600	600	600	600	780	780	780	780	960	960	960	960	1140	1140	1140	1320	1320	1320	
Weight (kg)	21.0	22.0	22.9	23.8	24.8	25.7	26.6	27.5	28.5	29.4	30.3	31.2	32.1	33.0	34.0	34.9	35.8	36.7	37.7	38.6	39.5	40.4	
Maximum speed (mm/sec)	1000 (1200)											960	840	720	600	480							
Speed setting	-											80%	70%	60%	50%	40%							

- Note 6. When the stroke exceeds 800mm, although depending on the moving range, the ball screw may resonate (critical speed). In that case, make adjustment to lower the speed on the program using the maximum speed given in the above table as a guide.  
 Note 7. To operate the unit at a speed exceeding 1,000mm/sec. a regeneration unit RG1 is required.

- Articulated robots  
YA
- Linear conveyor modules  
LCM100
- Compact single-axis robots  
TRANSEVO
- Single-axis robots  
FLIP-X
- Linear motor single-axis robots  
PHASER
- Cartesian robots  
XY-X
- SCARA robots  
YK-X
- Pick & place robots  
YP-X
- CLEAN
- CONTROLLER INFORMATION
- T type
- F type
- GF type
- N type
- B/R type

## F20 High lead type: Lead 40

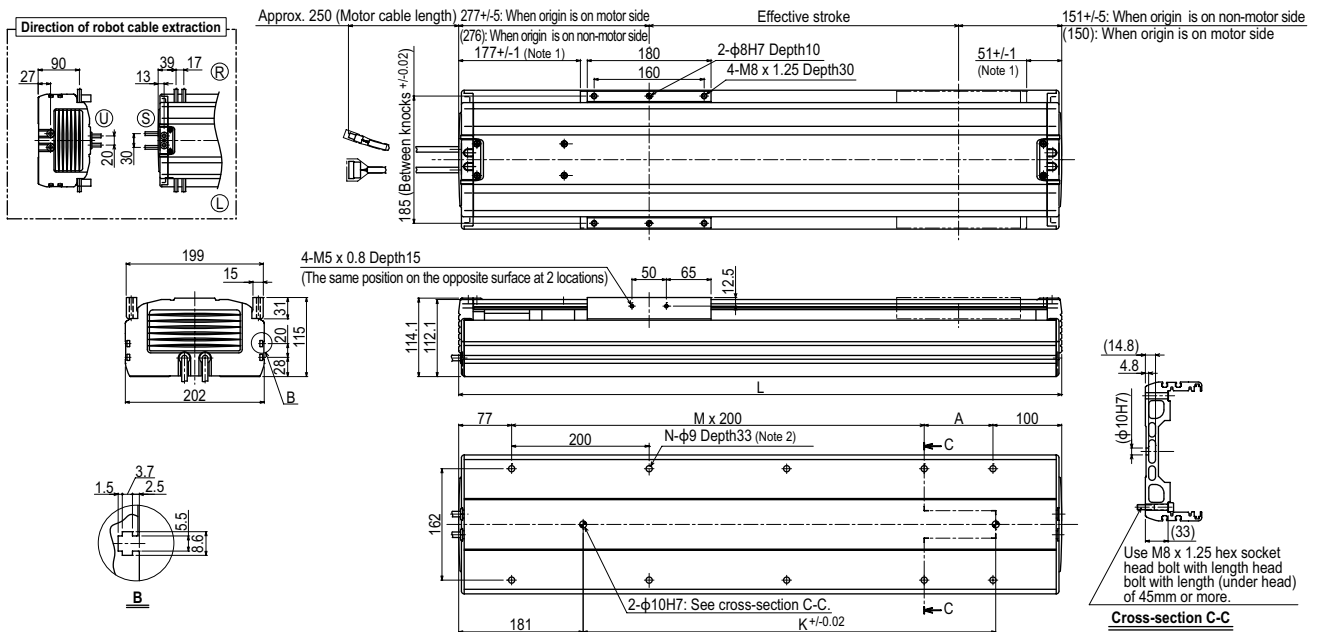

Note 1. Stop positions are determined by the mechanical stoppers at both ends.  
Note 2. When installing the robot, do not use washers inside the robot body.

Note 3. Minimum bend radius of motor cable is R50.

Effective stroke	200	250	300	350	400	450	500	550	600	650	700	750	800	850	900	950	1000	1050	1100	1150	1200	1250	1300	1350	1400	1450																																																																	
L	627	677	727	777	827	877	927	977	1027	1077	1127	1177	1227	1277	1327	1377	1427	1477	1527	1577	1627	1677	1727	1777	1827	1877																																																																	
A	50	100	150	200	50	100	150	200	50	100	150	200	50	100	150	200	50	100	150	200	50	100	150	200	50	100																																																																	
M	2	2	2	2	3	3	3	3	4	4	4	4	5	5	5	6	6	6	6	7	7	7	7	7	8	8																																																																	
N	8	8	8	8	10	10	10	10	12	12	12	12	14	14	14	14	16	16	16	16	18	18	18	18	20	20																																																																	
K	420	420	420	420	600	600	600	600	780	780	780	780	960	960	960	960	1140	1140	1140	1320	1320	1320	1320	1320	1320	1320																																																																	
Weight (kg)	21.2	22.2	23.1	24.0	25.0	25.9	26.8	27.7	28.7	29.6	30.5	31.4	32.3	33.2	34.2	35.1	36.0	36.9	37.9	38.8	39.7	40.6	41.5	42.4	43.3	44.2																																																																	
Maximum speed <sup>Note 4</sup> (mm/sec)	<b>Lead 40</b>														2400																																																																												
Speed setting	-														80%											70%											60%											50%											40%											35%											30%										

Note 4. When the stroke is longer than 800mm, resonance of the ball screw may occur depending on the operation conditions (critical speed). In this case, reduce the speed setting on the program by referring to the maximum speeds shown in the table above.  
Note 5. Longer than 1250mm stroke can be handled by the high lead specification (Lead 40) only.

# F20N



## Ordering method

**F20N - 20**

<b>Model</b>	<b>Lead designation</b>	<b>Origin position change</b> None: Standard Z: Non-motor side	<b>Grease type</b> None: Standard GC: Clean	<b>Stroke</b> 1150 to 2050 (100mm pitch)	<b>Cable length</b> <sup>Note 1</sup> 3L: 3.5m 5L: 5m 10L: 10m 3K/5K/10K (Flexible cable)
--------------	-------------------------	--	---	--	--

<b>TSX</b>	<b>220</b>				
<b>Positioner</b> <sup>Note 2</sup> TS-X	<b>Driver: Power-supply voltage / Power capacity</b> 220: 200V/400 to 600W	<b>Regenerative unit</b> No entry: None R: With RGT	<b>LCD monitor</b> No entry: None L: With LCD	<b>I/O selection</b> NP: NPN PN: PNP CC: CC-Link DN: DeviceNet™ EP: EtherNet/IP™ PT: PROFINET GW: No I/O board <sup>Note 3</sup>	<b>Battery</b> B: With battery (Absolute) N: None (Incremental)
<b>SR1-X</b>	<b>20</b>				
<b>Controller</b>	<b>Driver: Power capacity</b> 20: 400 to 600W	<b>Usable for CE</b> No entry: Standard E: CE marking	<b>Regenerative unit</b> No entry: None R: With RGT	<b>I/O selection</b> N: NPN P: PNP CC: CC-Link DN: DeviceNet™ PB: PROFIBUS	<b>Battery</b> B: With battery (Absolute) N: None (Incremental)
<b>RDV-X</b>	<b>2</b>		<b>20</b>		<b>RBR1</b>
<b>Driver</b>	<b>Power-supply voltage</b> 2: AC200V		<b>Driver: Power capacity</b> 20: 600W or less		<b>Regenerative unit</b>

Note 1. The robot cable is standard cable (3L/5L/10L), but can be changed to flexible cable. See P.596 for details on robot cable.  
 Note 2. See P.500 for DIN rail mounting bracket.  
 Note 3. Select this selection when using the gateway function. For details, see P.62.

## Specifications

AC servo motor output (W)	400
Repeatability <sup>Note 1</sup> (mm)	+/-0.04
Deceleration mechanism	Ball screw
Ball screw lead (mm)	20
Maximum speed (mm/sec)	1000 (1200 <sup>Note 2</sup> )
Maximum payload (kg)	80
Rated thrust (N)	339
Stroke (mm)	1150 to 2050 (100mm pitch)
Overall length (mm)	Stroke+420
Maximum dimensions of cross section of main unit (mm)	W202 x H120
Cable length (m)	Standard: 3.5 / Option: 5.10
Linear guide type	4 rows of circular arc grooves x 2 rail
Position detector	Resolvers <sup>Note 3</sup>
Resolution (Pulse/rotation)	16384

Note 1. Positioning repeatability in one direction.  
 Note 2. A regenerative unit is needed if using the SR1-X, TS-X at maximum speeds exceeding 1000mm/sec.. If using the RDV-X, then the regenerative unit RBR1 is required regardless of the installation conditions.  
 Note 3. Position detectors(resolvers) are common to incremental and absolute specifications. If the controller has a backup function then it will be absolute specifications.

## Allowable overhang<sup>Note</sup>

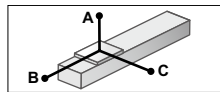

		Horizontal installation (Unit: mm)		
		A	B	C
Lead 20	20kg	3397	2332	2683
	40kg	2795	1144	1361
	60kg	2443	749	914
	80kg	2193	551	695

Note. Distance from center of slider top to center of gravity of object being carried at a guide service life of 10,000 km.

## Static loading moment

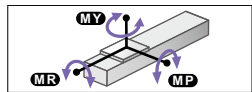

			(Unit: N·m)
MY	MP	MR	
1196	1199	1052	

## Controller

Controller	Operation method
SR1-X20 <sup>Note</sup> RCX221/222 RCX240/340	Programming / I/O point trace / Remote command / Operation using RS-232C communication
TS-X220 <sup>Note</sup> RDV-X220-RBR1	I/O point trace / Remote command / Pulse train control

Note. When the unit is operated at a speed exceeding the maximum speed of 1,000mm/sec., a regeneration unit is required.

## F20N

219+/-3: When origin is on L side  
 (219): When origin is on R side

Effective stroke

201+/-3: When origin is on R side  
 (201): When origin is on L side

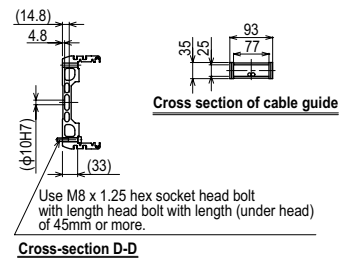
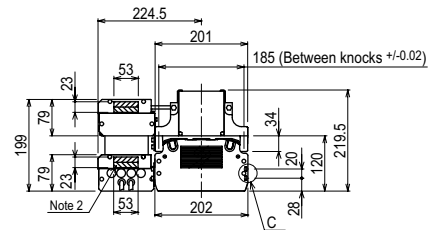
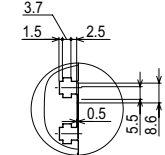
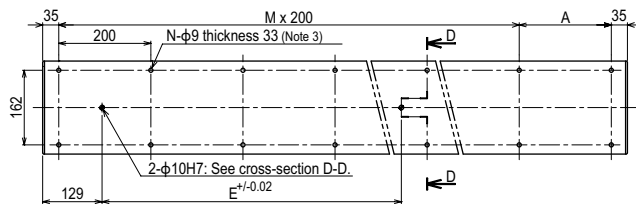
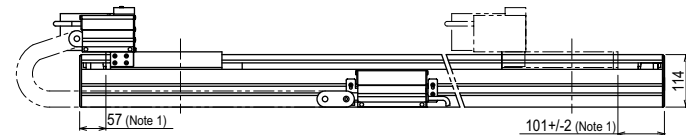
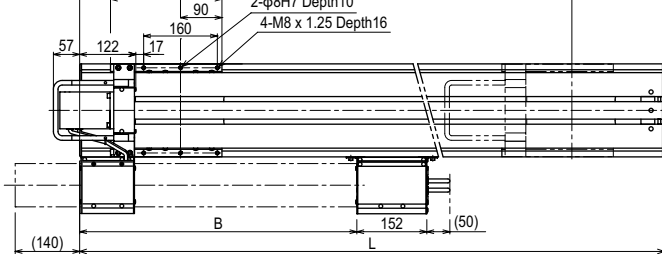

Effective stroke	1150	1250	1350	1450	1550	1650	1750	1850	1950	2050
L	1570	1670	1770	1870	1970	2070	2170	2270	2370	2470
A	100	200	100	200	100	200	100	200	100	200
B	602	648	694	740	786	832	878	924	970	1016
E	1320	1320	1320	1320	1320	1320	1320	1320	1320	1320
M	7	7	8	8	9	9	10	10	11	11
N	18	18	20	20	22	22	24	24	26	26
Weight (kg)	54.0	56.2	58.4	60.6	62.9	65.1	67.3	69.6	71.8	74.0

Note 1. Stop positions are determined by the mechanical stoppers at both ends.  
 Note 2. The shaded position indicates the user cable extraction port.  
 Note 3. When installing the robot, do not use washers inside the robot body.  
 Note 4. The origin is set on the left (L) side using a spring.

# N15



## Ordering method

**N15-20**

<b>Model</b>	<b>Lead designation</b>	<b>Cable carrier entry location</b> RH: Horizontal, right LH: Horizontal, left RW: Wall, right LW: Wall, left	<b>Cable carrier specification</b> S: Standard Cable carrier M: Optional Cable carrier	<b>Origin position change</b> Horizontal: None, R side (Standard) Z: L side Wall: None, L side (Standard) Z: R side	<b>Grease type</b> None: Standard GC: Clean	<b>Stroke</b> 500 to 2000 (100mm pitch)	<b>Cable length</b> <sup>Note 2</sup> 3L: 3.5m 5L: 5m 10L: 10m 3K/5K/10K (Flexible cable)	<b>TSX</b> Positioner <sup>Note 3</sup> TS-X	<b>220</b> Driver: Power-supply voltage / Power capacity 220: 200V/400 to 600W	<b>R</b> Regenerative unit R: With RGT	<b>LCD monitor</b> No entry: None L: With LCD	<b>I/O selection</b> NP: NPN PN: PNP CC: CC-Link DN: DeviceNet™ EP: EtherNet/IP™ PT: PROFINET GW: No I/O board <sup>Note 4</sup>	<b>Battery</b> B: With battery (Absolute) N: None (Incremental)
<b>SR1-X</b> Controller	<b>20</b> Driver: Power capacity 20: 400 to 600W	<b>Usable for CE</b> No entry: Standard E: CE marking	<b>R</b> Regenerative unit R: With RGT1	<b>I/O selection</b> N: NPN P: PNP CC: CC-Link DN: DeviceNet™ PB: PROFIBUS	<b>Battery</b> B: With battery (Absolute) N: None (Incremental)								
<b>RDV-X</b> Driver	<b>2</b> Power-supply voltage 2: AC200V	<b>20</b> Driver: Power capacity 20: 600W or less	<b>RBR1</b> Regenerative unit										

Note 1. To find information on cable carrier extraction directions see P.175.  
 Note 2. The robot cable is standard cable (3L/5L/10L), but can be changed to flexible cable. See P.596 for details on robot cable.  
 Note 3. See P.500 for DIN rail mounting bracket.  
 Note 4. Select this selection when using the gateway function. For details, see P.62.

## Specifications

<b>AC servo motor output (W)</b>	400
<b>Repeatability</b> <sup>Note 1</sup> (mm)	+/-0.01
<b>Deceleration mechanism</b>	Ball screw $\phi 15$
<b>Ball screw lead (mm)</b>	20
<b>Maximum speed</b> <sup>Note 2</sup> (mm/sec)	1200
<b>Maximum payload (kg)</b>	50
<b>Rated thrust (N)</b>	339
<b>Stroke (mm)</b>	500 to 2000 (100mm pitch)
<b>Overall length (mm)</b>	Stroke+330
<b>Maximum dimensions of cross section of main unit (mm)</b>	W145 x H120
<b>Cable length (m)</b>	Standard: 3.5 / Option: 5.10
<b>Linear guide type</b>	4 rows of circular arc grooves x 2 rail
<b>Position detector</b>	Resolvers <sup>Note 3</sup>
<b>Resolution (Pulse/rotation)</b>	16384

Note 1. Positioning repeatability in one direction.  
 Note 2. The maximum speed may not be reached when the moving distance is short.  
 Note 3. Position detectors (resolvers) are common to incremental and absolute specifications. If the controller has a backup function then it will be absolute specifications.

## Allowable overhang

Note

Horizontal installation (Unit: mm)	Wall installation (Unit: mm)		
	A	B	C
<b>Lead 20</b>			
10kg	3048	2322	1259
30kg	1489	841	500
50kg	1278	544	344

Note. Distance from center of slider top to center of gravity of object being carried at a guide service life of 10,000 km.

## Static loading moment

(Unit: N·m)		
MY	MP	MR
691	692	608

## Controller

Controller	Operation method
SR1-X20-R RCX221/222 RCX240/340	Programming / I/O point trace / Remote command / Operation using RS-232C communication
TS-X220-R	I/O point trace / Remote command
RDV-X220-RBR1	Pulse train control

## Cable carrier for users

**S type Standard cable carrier**

Note. Cannot pass more than 3 urethane hoses ( $\phi 6 \times 4$ ).

**M type Optional cable carrier**

Space for optional cable for users

## N15: Horizontal installation / Standard Cable carrier specification RH

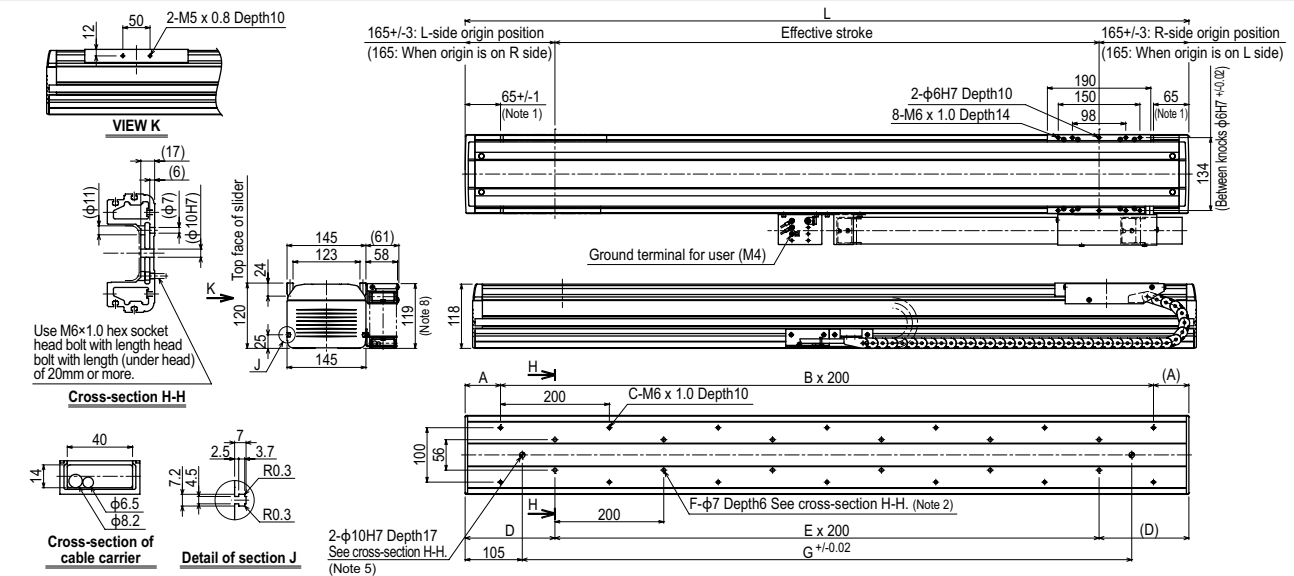

Note 1. Stop positions are determined by the mechanical stoppers at both ends.  
 Note 2. When using  $\phi 7$  holes for installation, do not use a washer, spring washer, etc. in the main unit.  
 Note 3. When shipped from the factory, the horizontal model has the origin on the right side and the wall model has the origin on the left side. (This diagram shows the machine whose cable carrier taken out from right.)  
 Note 4. If the model is a standard cable carrier specification, it is not possible to pass 3 or more  $\phi 6 \times 4$  urethane air hoses.  
 Note 5. When using a  $\phi 10H7$  hole, make sure that the pin does not go into deeper than as shown in the drawing.  
 Note 6. Contact us for vertical installation.  
 Note 7. Weight of models with no brake. The weight of brake-attached models is 1 kg heavier than the models with no brake shown in the table.  
 Note 8. Depending on the stroke and the operating conditions, the cable carrier bending radius might be larger, making it higher than the dimensions shown in the diagram.

Effective stroke	500	600	700	800	900	1000	1100	1200	1300	1400	1500	1600	1700	1800	1900	2000
<b>L</b>	830	930	1030	1130	1230	1330	1430	1530	1630	1730	1830	1930	2030	2130	2230	2330
<b>A</b>	15	65	15	65	15	65	15	65	15	65	15	65	15	65	15	65
<b>B</b>	4	4	5	5	6	6	7	7	8	8	9	9	10	10	11	11
<b>C</b>	10	10	12	12	14	14	16	16	18	18	20	20	22	22	24	24
<b>D</b>	115	165	115	165	115	165	115	165	115	165	115	165	115	165	115	165
<b>E</b>	3	3	4	4	5	5	6	6	7	7	8	8	9	9	10	10
<b>F</b>	8	8	10	10	12	12	14	14	16	16	18	18	20	20	22	22
<b>G</b>	620	720	820	920	1020	1120	1220	1320	1420	1520	1620	1720	1820	1920	2020	2120
<b>Weight (kg)</b> <sup>Note 7</sup>	19	20	22	23	24	26	27	29	30	32	33	35	36	38	39	40

N15: Horizontal installation / Optional Cable carrier specification **RH**

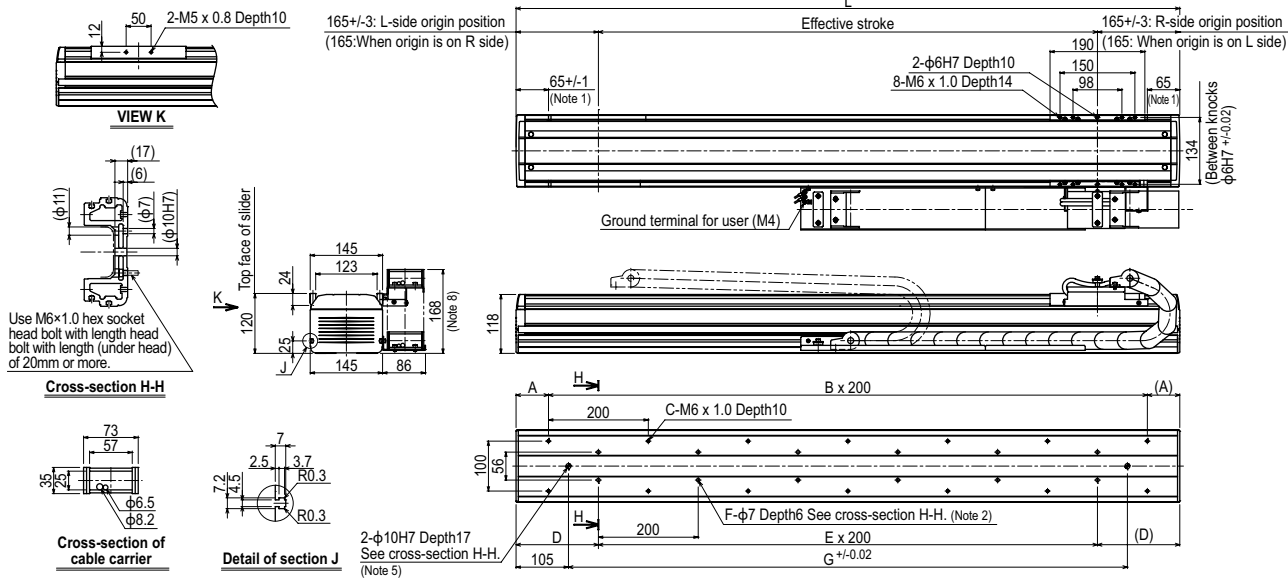

N15: Wall installation / Standard Cable carrier specification **RW**

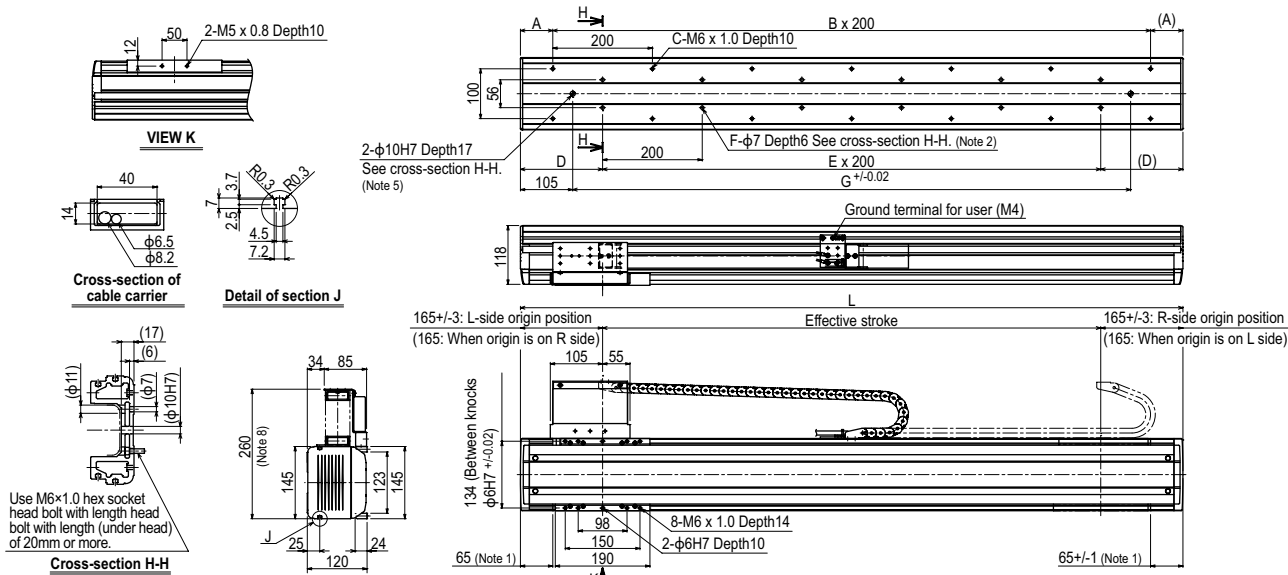

N15: Wall installation / Optional Cable carrier specification **RW**

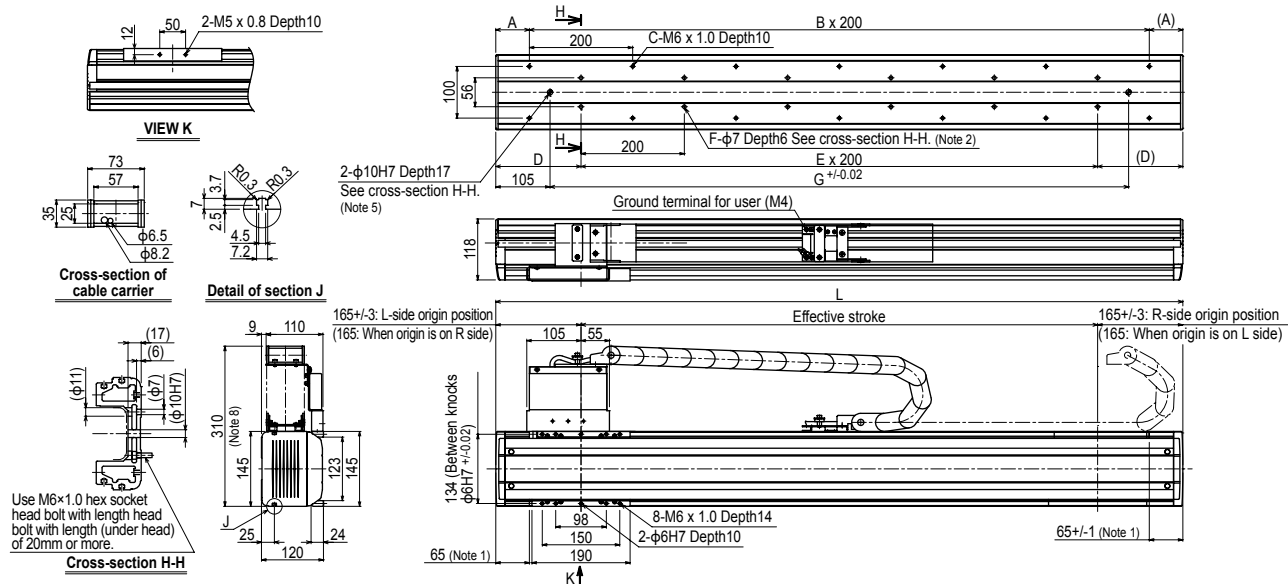

# N15D

Double carriage

## Ordering method

<b>N15D-20</b>							<b>RCX222HP</b>		<b>R</b>			
<b>Model</b>	<b>Lead designation</b>	<b>Installation direction</b>	<b>Cable carrier specification</b>	<b>Option</b>	<b>Stroke</b>	<b>Cable length</b>	<b>Controller</b> <sup>Note 1</sup>	<b>Usable for CE</b>	<b>Regenerative unit</b>	<b>I/O selection 1</b>	<b>I/O selection 2</b>	
		H: Horizontal installation W: Wall installation	S: Standard Cable carrier M: Optional Cable carrier	Grease type None: Standard GC: Clean	250 to 1750 (100mm pitch)	3L: 3.5m 5L: 5m 10L: 10m 3K/5K/10K (Flexible cable) <sup>Note 5</sup>	RCX222HP SR1-X (2 units) <sup>Note 2</sup> TS-X (2 units) <sup>Note 2</sup> RDV-X (2 units) <sup>Note 2</sup>	No entry : Standard E: CE marking	R: RG2	N: NPN <sup>Note 3</sup> P: PNP CC: CC-Link DN: DeviceNet™ PB: PROFIBUS EN: Ethernet <sup>Note 3</sup>	No entry: None NT: OPDIO24/16 (NPN) <sup>Note 3</sup> Pt: OPDIO24/17 (PNP) EN: Ethernet <sup>Note 3, Note 4</sup>	

Note 1. To find controller selection options for other than the RCX222HP, see the ordering method on each controller page.

Note 2. 2 units are required when using SR1-X, TS-X or RDV-X.

Note 3. NPN and Ethernet cannot be selected when using CE marking.

Note 4. Only when you have selected CC, DN or PB for Input/Output selection 1, you can select EN for Input/Output selection 2.

Note 5. If a flexible cable is needed for the SR1-X, TS-X, or RDV-X, then select 3K/5K/10K. On the RCX222HP, the standard cable is a flexible cable, so enter 3L/5L/10L when ordering.

## Specifications

AC servo motor output (W)	400
Repeatability <sup>Note 1</sup> (mm)	+/-0.01
Deceleration mechanism	Ball screw $\phi 15$
Ball screw lead (mm)	20
Maximum speed <sup>Note 2</sup> (mm/sec)	1200
Maximum payload (kg)	50
Rated thrust (N)	339
Stroke (mm)	250 to 1750 (100mm pitch)
Overall length (mm)	Stroke+330
Maximum dimensions of cross section of main unit (mm)	W145 x H120
Cable length (m)	Standard: 3.5 / Option: 5.10
Linear guide type	4 rows of circular arc grooves x 2 rail
Position detector	Resolvers <sup>Note 3</sup>
Resolution (Pulse/rotation)	16384

Note 1. Positioning repeatability in one direction.

Note 2. The maximum speed may not be reached when the moving distance is short.

Note 3. Position detectors (resolvers) are common to incremental and absolute specifications. If the controller has a backup function then it will be absolute specifications.

## Allowable overhang<sup>Note</sup>

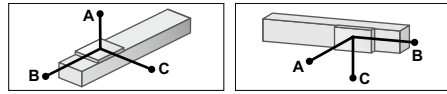

Lead 20	Horizontal installation (Unit: mm)			Wall installation (Unit: mm)		
	A	B	C	A	B	C
10kg	3048	2322	1259	10kg	1258	1823
30kg	1489	841	500	30kg	428	545
50kg	1278	544	344	50kg	248	289

Note. Distance from center of slider top to center of gravity of object being carried at a guide service life of 10,000 km.

## Static loading moment

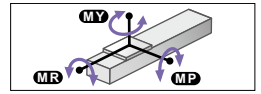

(Unit: N·m)		
MY	MP	MR
691	692	608

## Controller

Controller	Operation method
RCX222HP-R	Programming / I/O point trace / Remote command / Operation using RS-232C communication
SR1-X20-R <sup>Note</sup>	I/O point trace / Remote command
TS-X220-R <sup>Note</sup>	Pulse train control
RDV-X20-RBR1 <sup>Note</sup>	

Note. 2 units are required when using SR-1, TS-X or RDV-X.

## Cable carrier for users

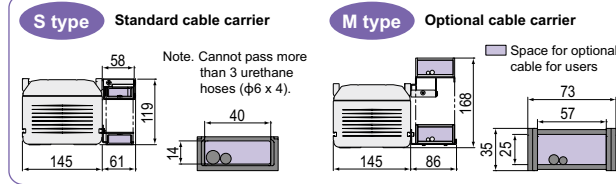

## N15D: Horizontal installation / Standard Cable carrier specification

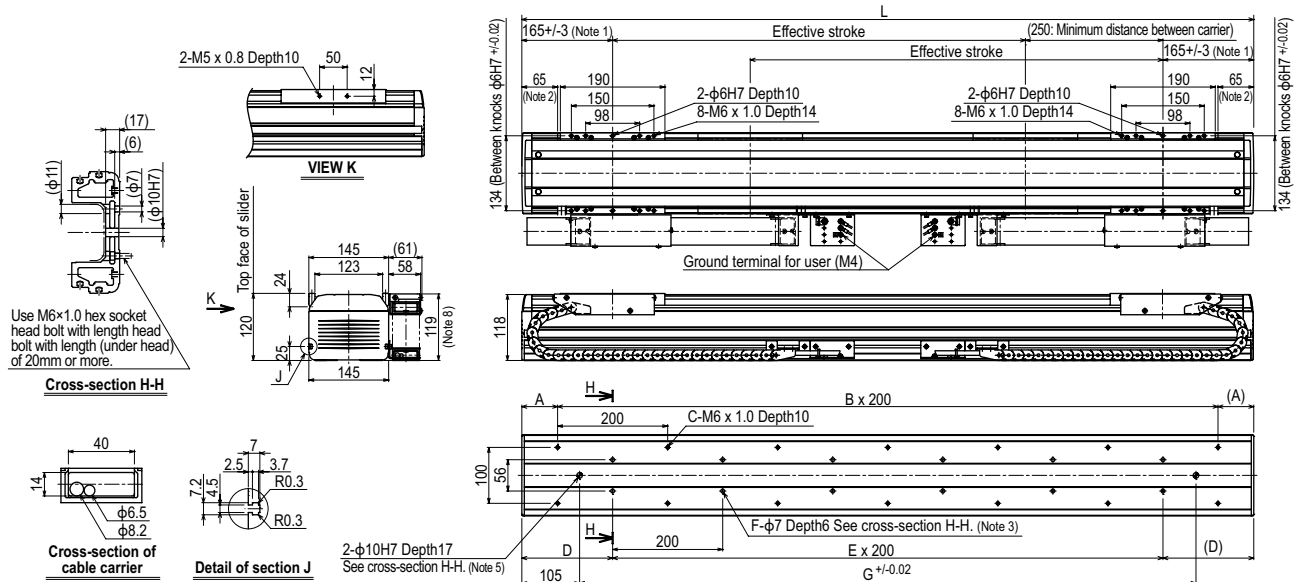

Note 1. Position of table carriage when searched to the origin.

Note 2. Stop positions are determined by the mechanical stoppers at both ends.

Note 3. When using  $\phi 7$  holes for installation, do not use a washer, spring washer, etc. in the main unit.

Note 4. If the model is a standard cable carrier specification, it is not possible to pass 3 or more  $\phi 6 \times 4$  urethane air hoses.

Note 5. When using a  $\phi 10H7$  hole, make sure that the pin does not go into deeper than as shown in the drawing.

Note 6. Contact us for vertical installation.

Note 7. Weight of models with no brake. The weight of brake-attached models is 1 kg heavier than the models with no brake shown in the table.

Note 8. Depending on the stroke and the operating conditions, the cable carrier bending radius might be larger, making it higher than the dimensions shown in the diagram.

Effective stroke	250	350	450	550	650	750	850	950	1050	1150	1250	1350	1450	1550	1650	1750
L	830	930	1030	1130	1230	1330	1430	1530	1630	1730	1830	1930	2030	2130	2230	2330
A	15	65	15	65	15	65	15	65	15	65	15	65	15	65	15	65
B	4	4	5	5	6	6	7	7	8	8	9	9	10	10	11	11
C	10	10	12	12	14	14	16	16	18	18	20	20	22	22	24	24
D	115	165	115	165	115	165	115	165	115	165	115	165	115	165	115	165
E	3	3	4	4	5	5	6	6	7	7	8	8	9	9	10	10
F	8	8	10	10	12	12	14	14	16	16	18	18	20	20	22	22
G	620	720	820	920	1020	1120	1220	1320	1420	1520	1620	1720	1820	1920	2020	2120
Weight (kg) <sup>Note 7</sup>	24	26	27	29	30	32	33	35	36	38	39	40	42	43	45	46



N15D: Horizontal installation / Optional Cable carrier specification

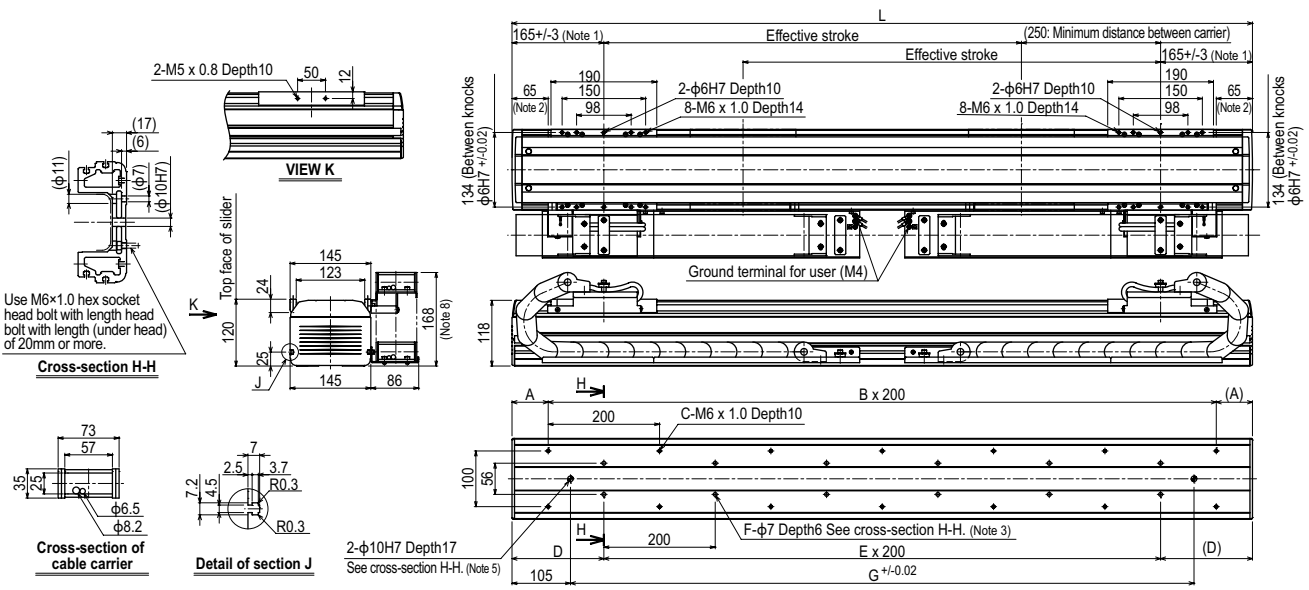

N15D: Wall installation / Standard Cable carrier specification

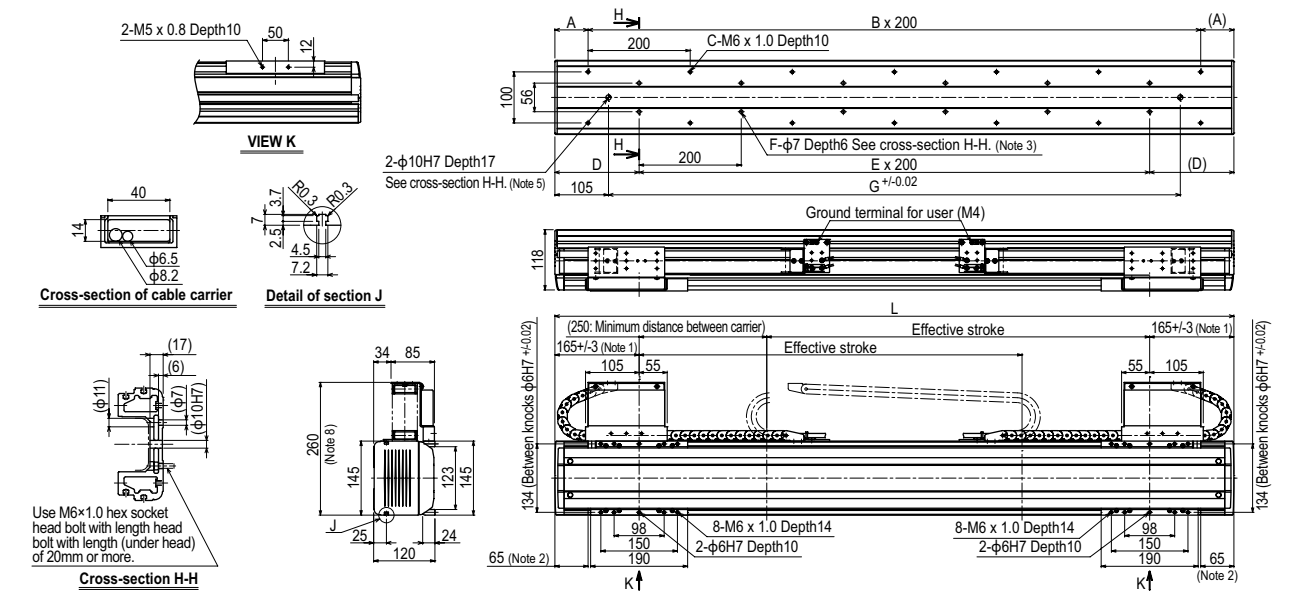

N15D: Wall installation / Optional Cable carrier specification

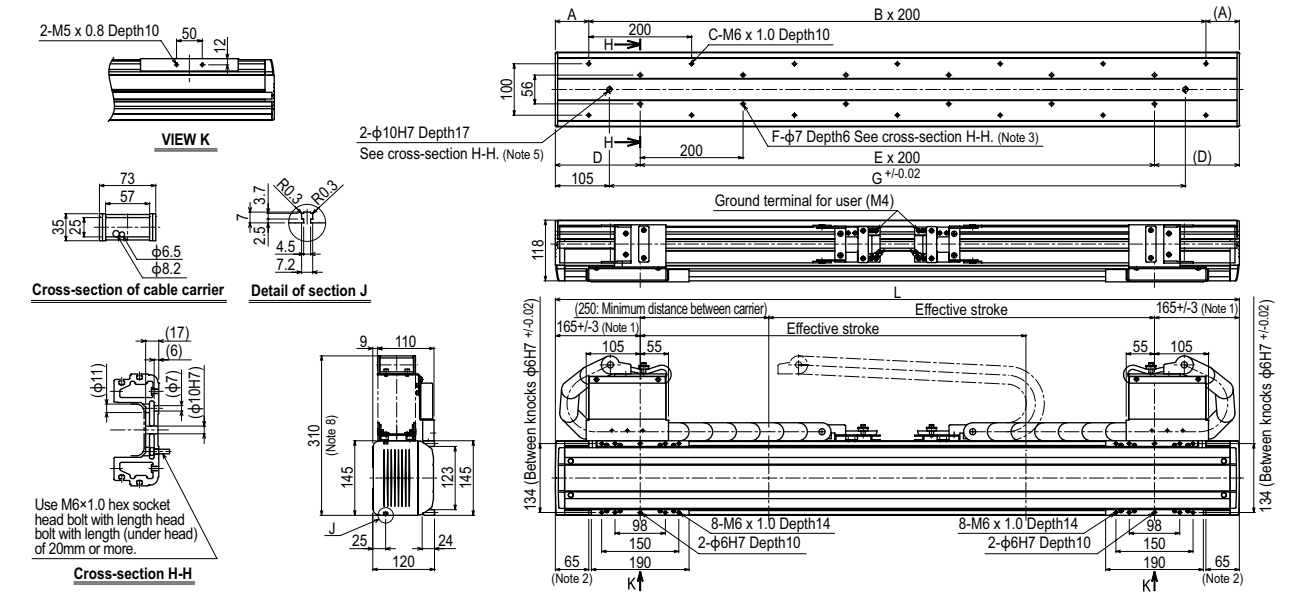

# N18



## Ordering method

**N18- 20**

<b>Model</b>	<b>Lead designation</b>	<b>Cable carrier entry location</b> RH: Horizontal, right LH: Horizontal, left RW: Wall, right LW: Wall, left	<b>Cable carrier specification</b> S: Standard Cable carrier M: Optional Cable carrier	<b>Origin position change</b> Horizontal: None, R side (Standard) Z: L side Wall: None, L side (Standard) Z: R side	<b>Grease type</b> None, Standard GC: Clean	<b>Stroke</b> 500 to 2500 (100mm pitch)	<b>Cable length</b> 3L: 3.5m 5L: 5m 10L: 10m 3K/5K/10K (Flexible cable)	<b>Positioner</b> TS-X	<b>220</b> Driver: Power-supply voltage / Power capacity 220: 200V/400 to 600W	<b>R</b> Regenerative unit R: With RGT	<b>LCD monitor</b> No entry: None L: With LCD	<b>I/O selection</b> NP: NPN P: PNP CC: CC-Link DN: DeviceNet™ EP: EtherNet/IP™ PT: PROFINET GW: No I/O board	<b>Battery</b> B: With battery (Absolute) N: None (Incremental)
--------------	-------------------------	---	--	---	---	--	---	---------------------------	--	--	---	--	---

<b>SR1-X</b>	<b>20</b>	<b>R</b>	<b>I/O selection</b> N: NPN P: PNP CC: CC-Link DN: DeviceNet™ PB: PROFIBUS	<b>Battery</b> B: With battery (Absolute) N: None (Incremental)
<b>Controller</b>	Driver: Power capacity 20: 400 to 600W	Usable for CE No entry: Standard E: CE marking	Regenerative unit R: With RGT	

<b>RDV-X</b>	<b>2</b>	<b>20</b>	<b>RBR1</b>
<b>Driver</b>	Power-supply voltage 2: AC200V	Driver: Power capacity 20: 600W or less	Regenerative unit

Note 1. To find information on cable carrier extraction directions see P.175.  
 Note 2. The robot cable is standard cable (3L/5L/10L), but can be changed to flexible cable. See P.596 for details on robot cable.  
 Note 3. See P.500 for DIN rail mounting bracket.  
 Note 4. Select this selection when using the gateway function. For details, see P.62.

## Specifications

AC servo motor output (W)	400
Repeatability <sup>Note 1</sup> (mm)	+/-0.01
Deceleration mechanism	Ball screw φ20
Ball screw lead (mm)	20
Maximum speed <sup>Note 2</sup> (mm/sec)	1200
Maximum payload (kg)	80
Rated thrust (N)	339
Stroke (mm)	500 to 2500 (100mm pitch)
Overall length (mm)	Stroke+362
Maximum dimensions of cross section of main unit (mm)	W180 × H115
Cable length (m)	Standard: 3.5 / Option: 5.10
Linear guide type	4 rows of circular arc grooves × 2 rail
Position detector	Resolvers <sup>Note 3</sup>
Resolution (Pulse/rotation)	16384

Note 1. Repeatability for single oscillation.  
 Note 2. The maximum speed may not be reached when the moving distance is short.  
 Note 3. Position detectors (resolvers) are common to incremental and absolute specifications. If the controller has a backup function then it will be absolute specifications.

## Allowable overhang<sup>Note</sup>

Horizontal installation (Unit: mm)	Horizontal installation (Unit: mm)			Wall installation (Unit: mm)		
	A	B	C	A	B	C
Lead 20	3045	1629	1902	3045	1928	1553
30kg	3045	1629	1902	3045	1928	1553
50kg	2602	961	1150	1157	885	2602
80kg	2193	586	716	707	509	2193

Note. Distance from center of slider top to center of gravity of object being carried at a guide service life of 10,000 km.

## Static loading moment

(Unit: N·m)		
MY	MP	MR
1161	1163	1021

## Controller

Controller	Operation method
SR1-X20-R RCX221/222 RCX240/340	Programming / I/O point trace / Remote command / Operation using RS-232C communication
TS-X220-R	I/O point trace / Remote command
RDV-X220-RBR1	Pulse train control

## Cable carrier for users

**S type Standard cable carrier**  
 Note. Cannot pass more than 3 urethane hoses (φ6 × 4).  
 Dimensions: 180mm width, 114mm height, 58mm top flange, 61mm base, 14mm hole offset.

**M type Optional cable carrier**  
 Space for optional cable for users.  
 Dimensions: 180mm width, 166mm height, 86mm base, 73mm top flange, 57mm hole offset, 35mm hole offset.

## N18: Horizontal installation / Standard Cable carrier specification RH

**Cross-section E-E**  
 Use M8 x 1.25 hex socket head bolt with length head bolt with length (under head) of 40mm or more.  
 Dimensions: 179mm total width, 156mm main width, 58mm top flange, 36mm hole offset, 115mm height, 22mm base, 180mm main width, 61mm hole offset, 114mm height, 113mm total height.

**Cross-section of cable carrier**  
 Dimensions: 40mm width, 14mm hole offset, φ6.5 hole, φ8.2 hole.

**Detail of section F**  
 Dimensions: 7mm total width, 2.5mm hole offset, 3.7mm hole offset, R1, R0.3.

**Side View**  
 Effective stroke L, 181±/3 L-side origin position (181: When origin is on R side), 78±/1 (Note 1), 181±/3 R-side origin position (181: When origin is on L side), 190mm hole offset, 150mm hole offset, 98mm hole offset, 2-φ6H7 Depth10, 8-M8 x 1.25 Depth25, 168mm height (Between knuckles φ6H7 +0.02), Ground terminal for user (M4), (Note 7), 200mm distance, B x 200, C-φ9 Depth30 See cross-section E-E. (Note 2), 149mm height, 2-φ10H7 Depth15 See cross-section E-E. (Note 5), D ±/0.02.

Note 1. Stop positions are determined by the mechanical stoppers at both ends.  
 Note 2. When using φ9 holes for installation, do not use a washer, spring washer, etc. in the main unit.  
 Note 3. When shipped from the factory, the horizontal model has the origin on the right side and the wall model has the origin on the left side. (This diagram shows the machine whose cable carrier taken out from right.)  
 Note 4. If the model is a standard cable carrier specification, it is not possible to pass 3 or more φ6 × 4 urethane air hoses.  
 Note 5. When using a φ10H7 hole, make sure that the pin does not go into deeper than as shown in the drawing.  
 Note 6. Contact us for vertical installation.  
 Note 7. For the robot with more than 2,100 stroke, a roller is installed to prevent the cable carrier hanging.  
 Note 8. Weight of models with no brake. The weight of brake-attached models is 1 kg heavier than the models with no brake shown in the table.  
 Note 9. Depending on the stroke and the operating conditions, the cable carrier bending radius might be larger, making it higher than the dimensions shown in the diagram.

Effective stroke	500	600	700	800	900	1000	1100	1200	1300	1400	1500	1600	1700	1800	1900	2000	2100	2200	2300	2400	2500
L	862	962	1062	1162	1262	1362	1462	1562	1662	1762	1862	1962	2062	2162	2262	2362	2462	2562	2662	2762	2862
A	131	81	131	81	131	81	131	81	131	81	131	81	131	81	131	81	131	81	131	81	131
B	3	4	4	5	5	6	6	7	7	8	8	9	9	10	10	11	11	12	12	13	13
C	8	10	10	12	12	14	14	16	16	18	18	20	20	22	22	24	24	26	26	28	28
D	650	750	850	950	1050	1150	1250	1350	1450	1550	1650	1750	1850	1950	2050	2150	2250	2350	2450	2550	2650
Weight (kg) <sup>Note 8</sup>	27	29	31	33	35	37	39	41	43	45	47	48	50	52	54	56	58	60	62	64	66

N18: Horizontal installation / Optional Cable carrier specification **RH**

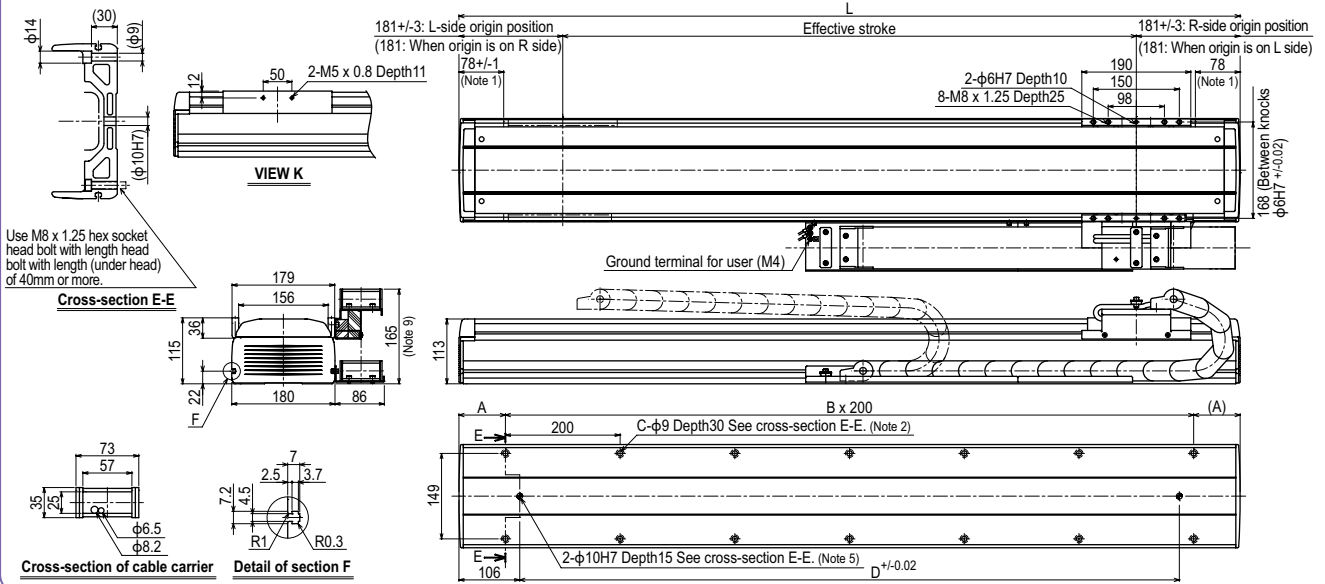

N18: Wall installation / Standard Cable carrier specification **RW**

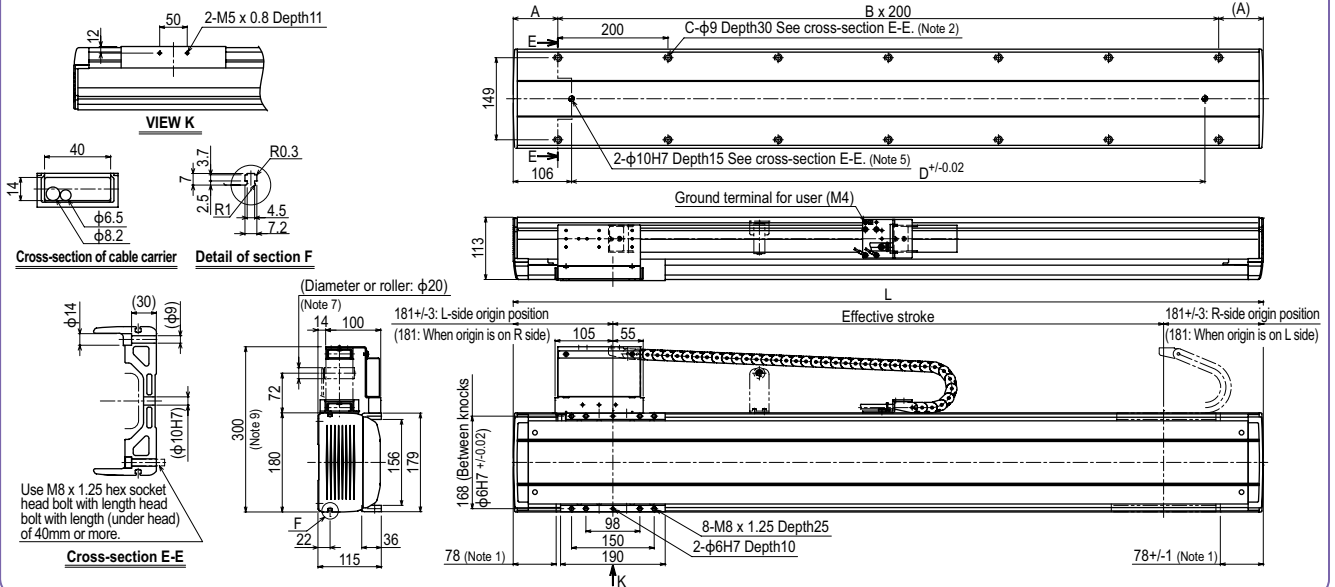

N18: Wall installation / Optional Cable carrier specification **RW**

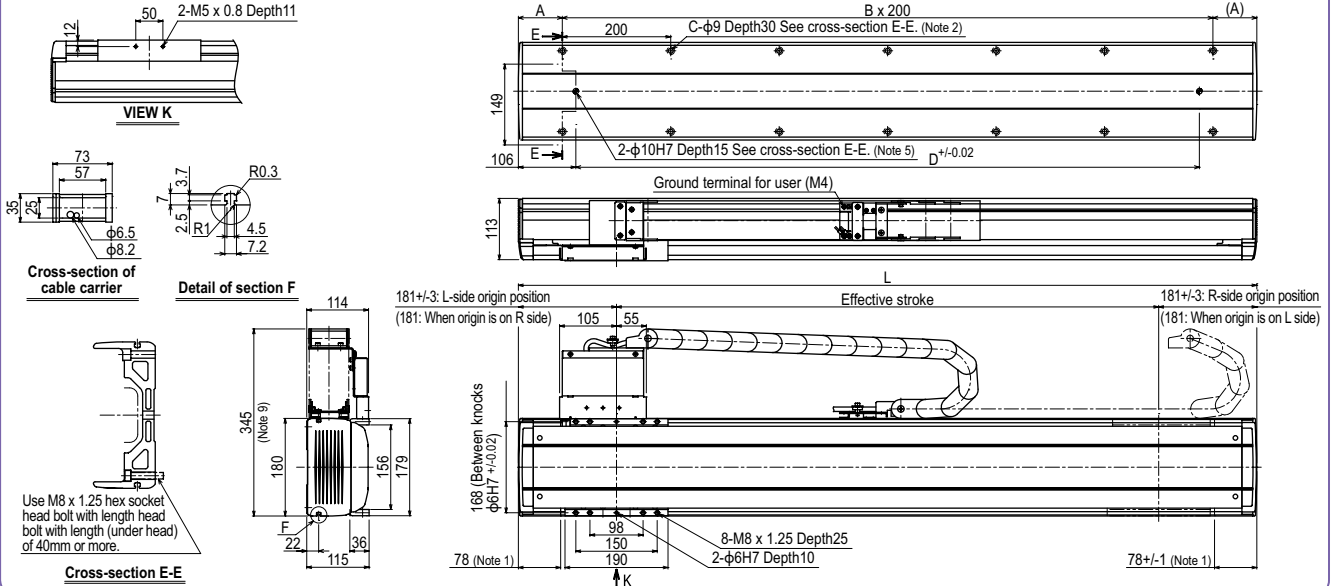

Articulated robots  
YA

Linear conveyor modules  
LCM100

Compact single-axis robots  
TRANSEVO

Single-axis robots  
FLIP-X

Linear motor single-axis robots  
PHASER

Cartesian robots  
XX-X

SCARA robots  
YK-X

Pick & place robots  
YP-X

CLEAN

CONTROLLER INFORMATION

T type

F type

GF type

N type

B/R type

# N18D

Double carriage

## Ordering method

<b>N18D - 20</b>						<b>RCX222HP</b>		<b>R</b>			
<b>Model</b>	<b>Lead designation</b>	<b>Installation direction</b>	<b>Cable carrier specification</b>	<b>Option</b>	<b>Stroke</b>	<b>Cable length</b>	<b>Controller</b> <sup>Note 1</sup>	<b>Usable for CE</b>	<b>Regenerative unit</b>	<b>I/O selection1</b>	<b>I/O selection2</b>
		H: Horizontal installation W: Wall installation	S: Standard Cable carrier M: Optional Cable carrier	Grease type None: Standard GC: Clean	250 to 2250 (100mm pitch)	3L: 3.5m 5L: 5m 10L: 10m 3K/5K/10K (Flexible cable) <sup>Note 5</sup>	RCX222HP SR1-X (2 units) <sup>Note 2</sup> TS-X (2 units) <sup>Note 2</sup> RDV-X (2 units) <sup>Note 2</sup>	No entry: Standard E: CE marking	R: RG2	N: NPN <sup>Note 3</sup> P: PNP CC: CC-Link DN: DeviceNet™ PB: PROFIBUS EN: Ethernet <sup>Note 3</sup>	No entry: None N1: OP.DI024/16 (NPN) <sup>Note 3</sup> P1: OP.DI024/17 (PNP) EN: Ethernet <sup>Note 3</sup> <sup>Note 4</sup>

Note 1. To find controller selection options for other than the RCX222HP, see the ordering method on each controller page.  
 Note 2. 2 units are required when using SR1-X, TS-X or RDV-X.  
 Note 3. NPN and Ethernet cannot be selected when using CE marking.  
 Note 4. Only when you have selected CC, DN or PB for Input/Output selection 1, you can select EN for Input/Output selection 2.  
 Note 5. If a flexible cable is needed for the SR1-X, TS-X, or RDV-X, then select 3K/5K/10K. On the RCX222HP, the standard cable is a flexible cable, so enter 3L/5L/10L when ordering.

## Specifications

<b>AC servo motor output (W)</b>	400
<b>Repeatability</b> <sup>Note 1</sup> (mm)	+/-0.01
<b>Deceleration mechanism</b>	Ball screw $\phi 20$
<b>Ball screw lead (mm)</b>	20
<b>Maximum speed</b> <sup>Note 2</sup> (mm/sec)	1200
<b>Maximum payload (kg)</b>	80
<b>Rated thrust (N)</b>	339
<b>Stroke (mm)</b>	250 to 2250 (100 pitch)
<b>Overall length (mm)</b>	Stroke+362
<b>Maximum dimensions of cross section of main unit (mm)</b>	W180 x H115
<b>Cable length (m)</b>	Standard: 3.5 / Option: 5, 10
<b>Linear guide type</b>	4 rows of circular arc grooves x 2 rail
<b>Position detector</b>	Resolvers <sup>Note 3</sup>
<b>Resolution (Pulse/rotation)</b>	16384

Note 1. Positioning repeatability in one direction.  
 Note 2. The maximum speed may not be reached when the moving distance is short.  
 Note 3. Position detectors (resolvers) are common to incremental and absolute specifications. If the controller has a backup function then it will be absolute specifications.

## Allowable overhang <sup>Note</sup>

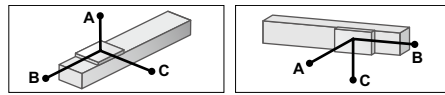

Horizontal installation	(Unit: mm)			Wall installation	(Unit: mm)		
	A	B	C		A	B	C
Lead 20	30kg	3045	1629	30kg	1928	1553	3045
	50kg	2602	961	50kg	1157	885	2602
	80kg	2193	586	80kg	707	509	2193

Note. Distance from center of slider top to center of gravity of object being carried at a guide service life of 10,000 km.

## Static loading moment

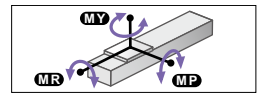

(Unit: N·m)		
MY	MP	MR
1161	1163	1021

## Controller

Controller	Operation method
RCX222HP-R	Programming / I/O point trace / Remote command / Operation using RS-232C communication
SR1-X20-R <sup>Note</sup>	I/O point trace / Remote command
TS-X220-R <sup>Note</sup>	Pulse train control
RDV-X20-RBR1 <sup>Note</sup>	

Note. 2 units are required when using SR1-X, TS-X or RDV-X.

## Cable carrier for users

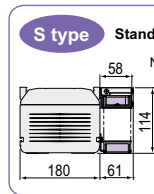
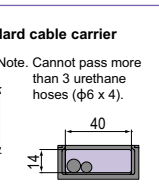
S type	Standard cable carrier	M type	Optional cable carrier
	180 x 114 x 61 mm		180 x 165 x 86 mm
	Note. Cannot pass more than 3 urethane hoses ( $\phi 6 \times 4$ ).		Space for optional cable for users

## N18D: Horizontal installation / Standard Cable carrier specification

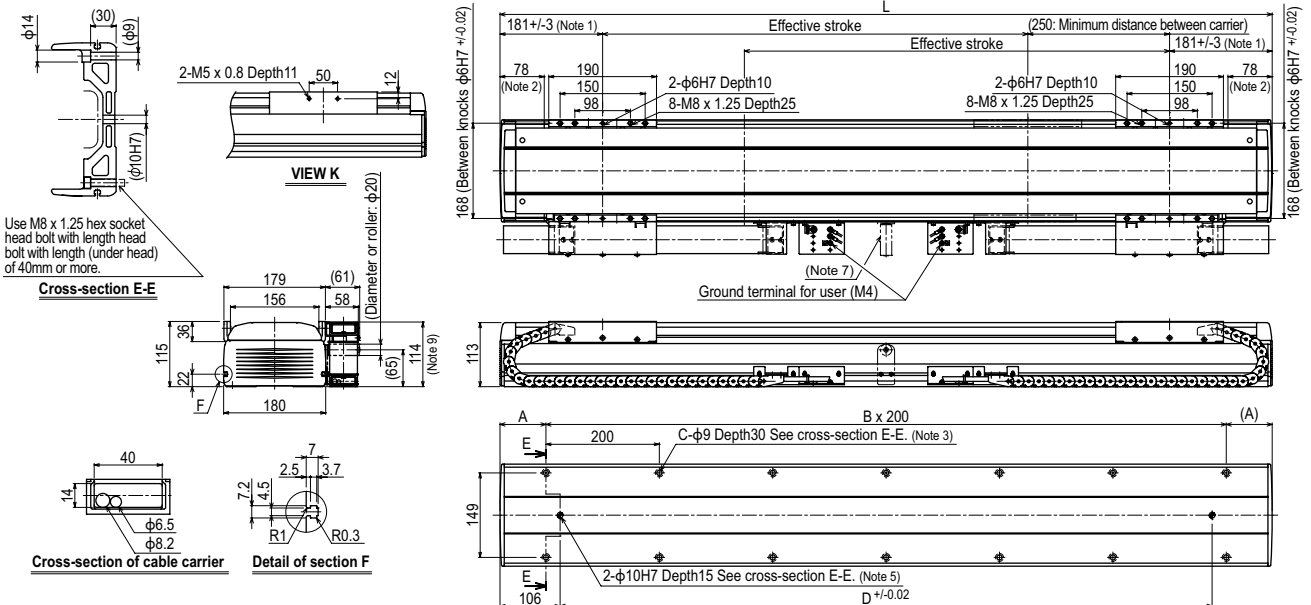

Note 1. Position of table carriage when searched to the origin.  
 Note 2. Stop positions are determined by the mechanical stoppers at both ends.  
 Note 3. When using  $\phi 9$  holes for installation, do not use a washer, spring washer, etc. in the main unit.  
 Note 4. If the model is a standard cable carrier specification, it is not possible to pass 3 or more  $\phi 6 \times 4$  urethane air hoses.  
 Note 5. When using a  $\phi 10H7$  hole, make sure that the pin does not go into deeper than as shown in the drawing.  
 Note 6. Contact us for vertical installation.  
 Note 7. For the robot with more than 2,050 stroke, a roller to prevent the cable carrier from hanging is provided.  
 Note 8. Weight of models with no brake. The weight of brake-attached models is 1 kg heavier than the models with no brake shown in the table.  
 Note 9. Depending on the stroke and the operating conditions, the cable carrier bending radius might be larger, making it higher than the dimensions shown in the diagram.

Effective stroke	250	350	450	550	650	750	850	950	1050	1150	1250	1350	1450	1550	1650	1750	1850	1950	2050	2150	2250
<b>L</b>	862	962	1062	1162	1262	1362	1462	1562	1662	1762	1862	1962	2062	2162	2262	2362	2462	2562	2662	2762	2862
<b>A</b>	131	81	131	81	131	81	131	81	131	81	131	81	131	81	131	81	131	81	131	81	131
<b>B</b>	3	4	4	5	5	6	6	7	7	8	8	9	9	10	10	11	11	12	12	13	13
<b>C</b>	8	10	10	12	12	14	14	16	16	18	18	20	20	22	22	24	24	26	26	28	28
<b>D</b>	650	750	850	950	1050	1150	1250	1350	1450	1550	1650	1750	1850	1950	2050	2150	2250	2350	2450	2550	2650
<b>Weight (kg)</b> <sup>Note 8</sup>	35	37	39	41	43	45	47	48	50	52	54	56	58	60	62	64	66	68	70	72	74

N18D: Horizontal installation / Optional Cable carrier specification

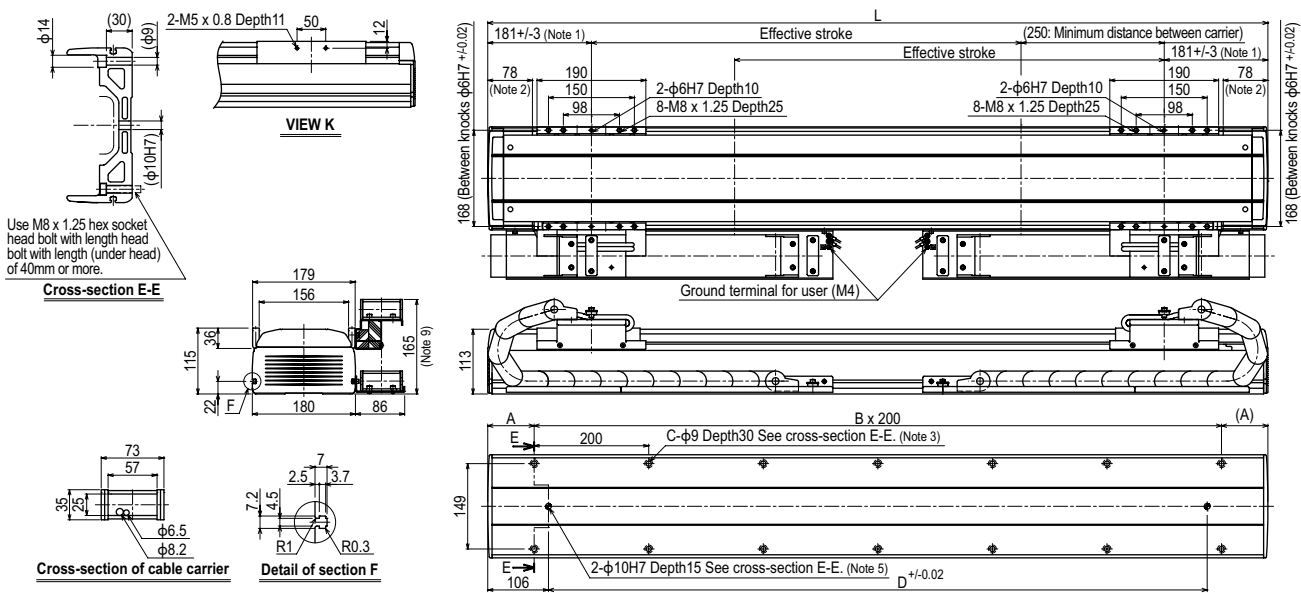

N18D: Wall installation / Standard Cable carrier specification

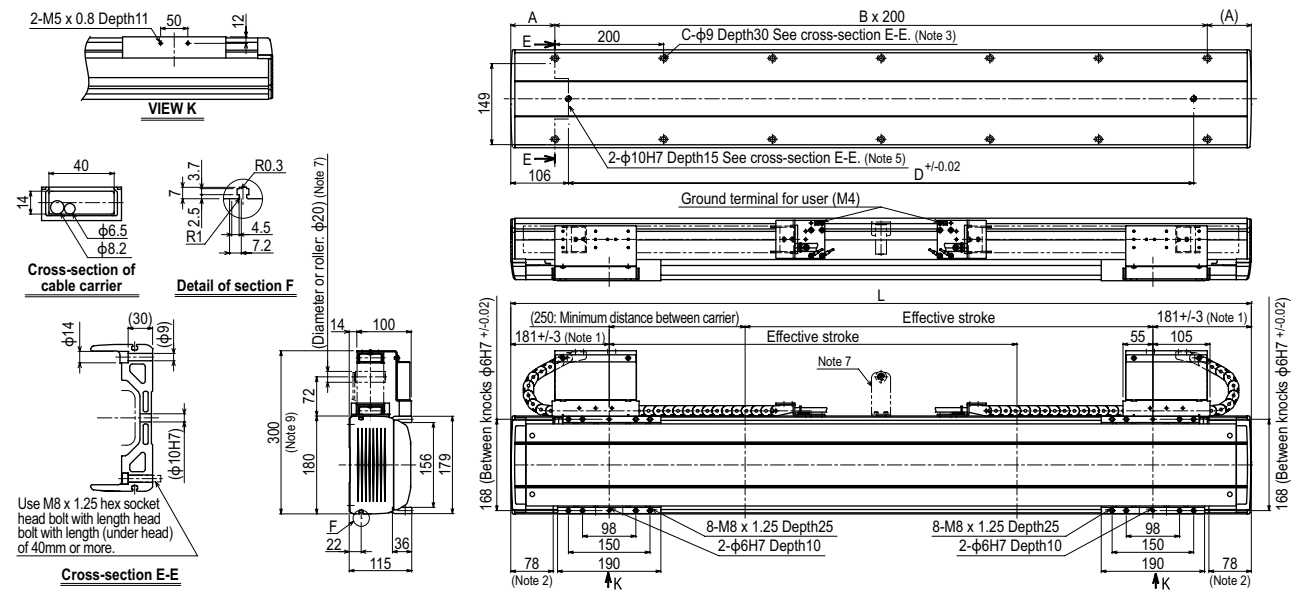

N18D: Wall installation / Optional Cable carrier specification

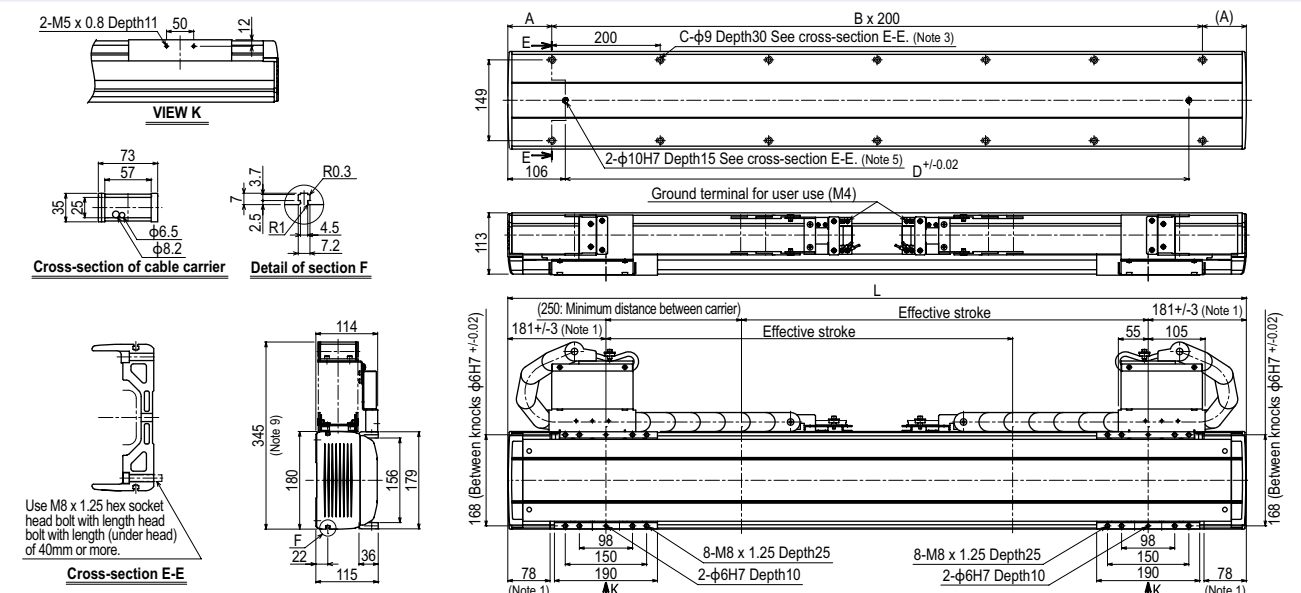

# B10



## Ordering method

### B10

Model	Motor installation direction	Option	Stroke	Cable length <sup>Note1</sup>
	L: Motor leftward, horizontal position R: Motor rightward, horizontal position LU: Motor leftward, upper position RU: Motor rightward, upper position LD: Motor leftward, lower position RD: Motor rightward, lower position	Grease type: None, Standard, GC: Clean	150 to 2550 (100mm pitch)	3L: 3.5m 5L: 5m 10L: 10m 3K/5K/10K (Flexible cable)

### TSX

Positioner <sup>Note2</sup> TS-X	Driver: Power-supply voltage / Power capacity	LCD monitor	I/O selection	Battery
	105: 100V/100W or less 205: 200V/100W or less	No entry: None L: With LCD	NP: NPN PN: PNP CC: CC-Link DN: DeviceNet™ EP: EtherNet/IP™ PT: PROFINET GW: No I/O board <sup>Note3</sup>	B: With battery (Absolute) N: None (Incremental)

### SR1-X

Controller	05	Usable for CE	I/O selection	Battery
	Driver: Power capacity 05: 100W or less	No entry: Standard E: CE marking	N: NPN P: PNP CC: CC-Link DN: DeviceNet™ PB: PROFIBUS	B: With battery (Absolute) N: None (Incremental)

### RDV-X

Driver	2	05	RBR1
	Power-supply voltage 2: AC200V	Driver: Power capacity 05: 100W or less	Regenerative unit

Note 1. The robot cable is standard cable (3L/5L/10L), but can be changed to flexible cable. See P.596 for details on robot cable.  
Note 2. See P.500 for DIN rail mounting bracket.  
Note 3. Select this selection when using the gateway function. For details, see P.62.

## Specifications

AC servo motor output (W)	100
Repeatability <sup>Note1</sup> (mm)	+/-0.04
Belt (mm)	Equivalent to lead 25
Maximum speed (mm/sec)	1875
Maximum payload (kg)	10
Stroke (mm)	150 to 2550 (100mm pitch)
Overall length (mm)	Stroke+397.5
Motor installation	Stroke+310
L/R type	
Another	
Maximum dimensions of cross section of main unit (mm)	W100 x H81
Cable length (m)	Standard: 3.5 / Option: 5.10
Linear guide type	4 rows of circular arc grooves x 1 rail
Position detector	Resolvers <sup>Note2</sup>
Resolution (Pulse/rotation)	16384

Note 1. Positioning repeatability in one direction.  
Note 2. Position detectors (resolvers) are common to incremental and absolute specifications. If the controller has a backup function then it will be absolute specifications.

## Allowable overhang<sup>Note</sup>

	Horizontal installation (Unit: mm)			Wall installation (Unit: mm)		
	A	B	C	A	B	C
3kg	1800	1392	1084	1144	1005	1734
5kg	1574	826	696	724	576	1199
8kg	1221	509	474	493	333	918
10kg	1171	403	407	414	254	869

Note. Distance from center of slider top to center of gravity of object being carried at a guide service life of 10,000 km.

## Static loading moment

(Unit: N·m)		
MY	MP	MR
188	188	165

## Controller

Controller	Operation method
SR1-X05	Programming / I/O point trace / Remote command / Operation using RS-232C communication
RCX221/222	
RCX240/340	
TS-X105	I/O point trace / Remote command
TS-X205	
RDV-X205-RBR1	Pulse train control

## Motor installation The line-up consisting of six models of different motor installation position as follows.

<b>L type</b> Leftward at horizontal position	<b>R type</b> Rightward at horizontal position	<b>LU type</b> Leftward at upper position	<b>RU type</b> Rightward at upper position	<b>LD type</b> Leftward at lower position	<b>RD type</b> Rightward at lower position
---	--	---	--	---	--

## B10 R type (Motor rightward, horizontal position)

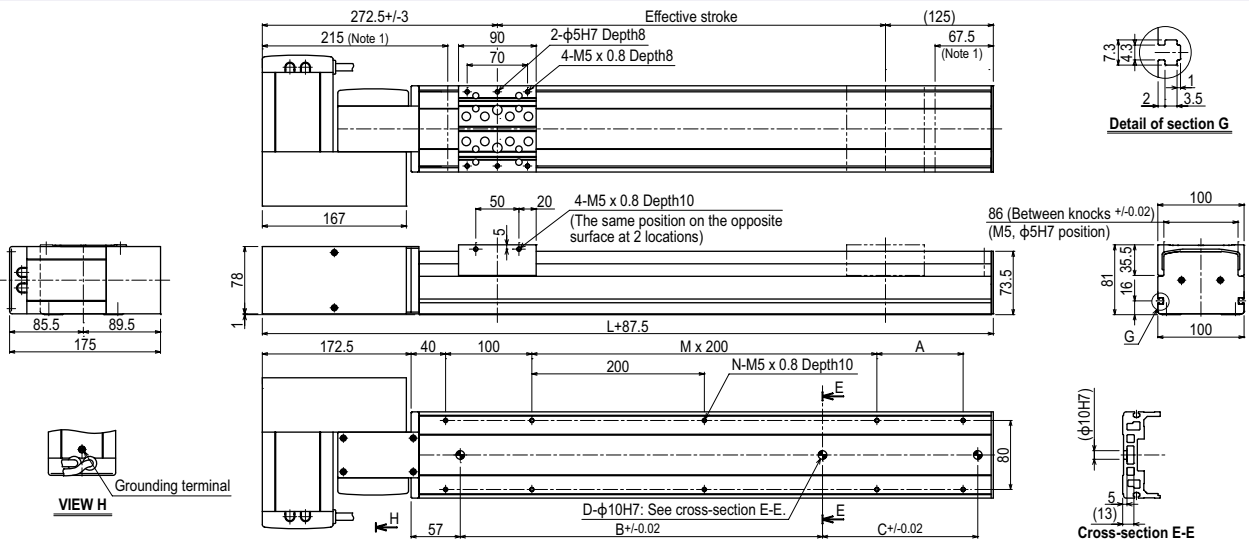

Effective stroke	150	200	250	300	350	400	450	500	550	600	650	700	750	800	850	900	950	1000	1050	1100	1150	1200	1250	1300	1350
L	460	510	560	610	660	710	760	810	860	910	960	1010	1060	1110	1160	1210	1260	1310	1360	1410	1460	1510	1560	1610	1660
A	200	50	100	150	200	50	100	150	200	50	100	150	200	50	100	150	200	50	100	150	200	50	100	150	200
B	240	240	240	420	420	420	600	600	600	600	780	780	780	780	960	960	960	960	1140	1140	1140	1140	1320	1320	1320
C	-	-	-	-	-	-	-	-	-	-	-	-	-	-	-	-	-	-	-	-	-	-	-	-	-
D	2	2	2	2	2	2	2	2	2	2	2	2	2	2	2	2	2	2	2	2	2	2	2	2	2
M	-	1	1	1	1	1	2	2	2	2	3	3	3	3	4	4	4	5	5	5	5	6	6	6	6
N	6	8	8	8	8	10	10	10	10	12	12	12	12	14	14	14	14	16	16	16	16	18	18	18	18
Weight (kg)	7.4	7.8	8.2	8.6	9.0	9.4	9.8	10.1	10.5	10.9	11.3	11.7	12.1	12.5	12.9	13.3	13.7	14.1	14.5	14.9	15.3	15.7	16.1	16.5	16.9

Effective stroke	1400	1450	1500	1550	1600	1650	1700	1750	1800	1850	1900	1950	2000	2050	2100	2150	2200	2250	2300	2350	2400	2450	2500	2550
L	1710	1760	1810	1860	1910	1960	2010	2060	2110	2160	2210	2260	2310	2360	2410	2460	2510	2560	2610	2660	2710	2760	2810	2860
A	50	100	150	200	50	100	150	200	50	100	150	200	50	100	150	200	50	100	150	200	50	100	150	200
B	1320	1320	1320	1320	1320	1320	1320	1320	1320	1320	1320	1320	1320	1320	1320	1320	1320	1320	1320	1320	1320	1320	1320	1320
C	-	240	240	240	420	420	420	420	600	600	600	600	780	780	780	780	960	960	960	960	1140	1140	1140	1140
D	2	3	3	3	3	3	3	3	3	3	3	3	3	3	3	3	3	3	3	3	3	3	3	3
M	7	7	7	7	8	8	8	8	9	9	9	9	10	10	10	10	11	11	11	11	11	12	12	12
N	20	20	20	22	22	22	22	22	24	24	24	24	26	26	26	26	28	28	28	28	28	30	30	30
Weight (kg)	17.3	17.7	18.0	18.4	18.8	19.2	19.6	20.0	20.4	20.8	21.2	21.6	22.0	22.4	22.8	23.2	23.6	24.0	24.4	24.8	25.2	25.6	25.9	26.3

Note 1. Stop positions are determined by the mechanical stoppers at both ends.  
Note 2. Cables can be extracted in upward, downward, forward or rearward directions. (This figure shows the forward direction.)

B10 RU type (Motor rightward, upper position)

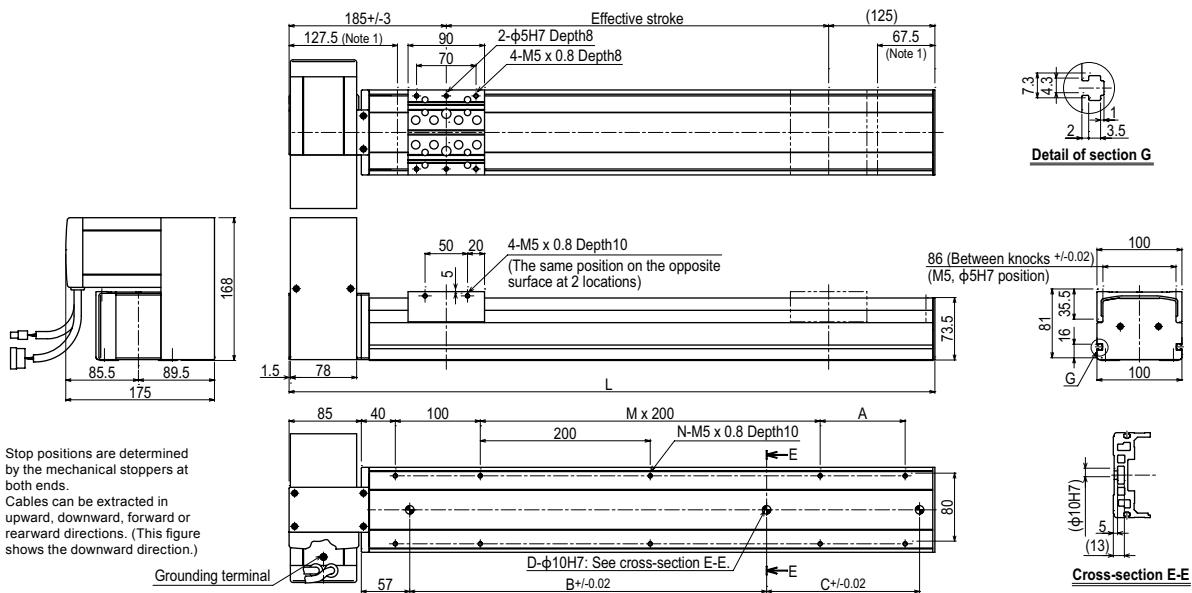

Note 1. Stop positions are determined by the mechanical stoppers at both ends.  
Note 2. Cables can be extracted in upward, downward, forward or rearward directions. (This figure shows the downward direction.)

B10 RD type (Motor rightward, lower position)

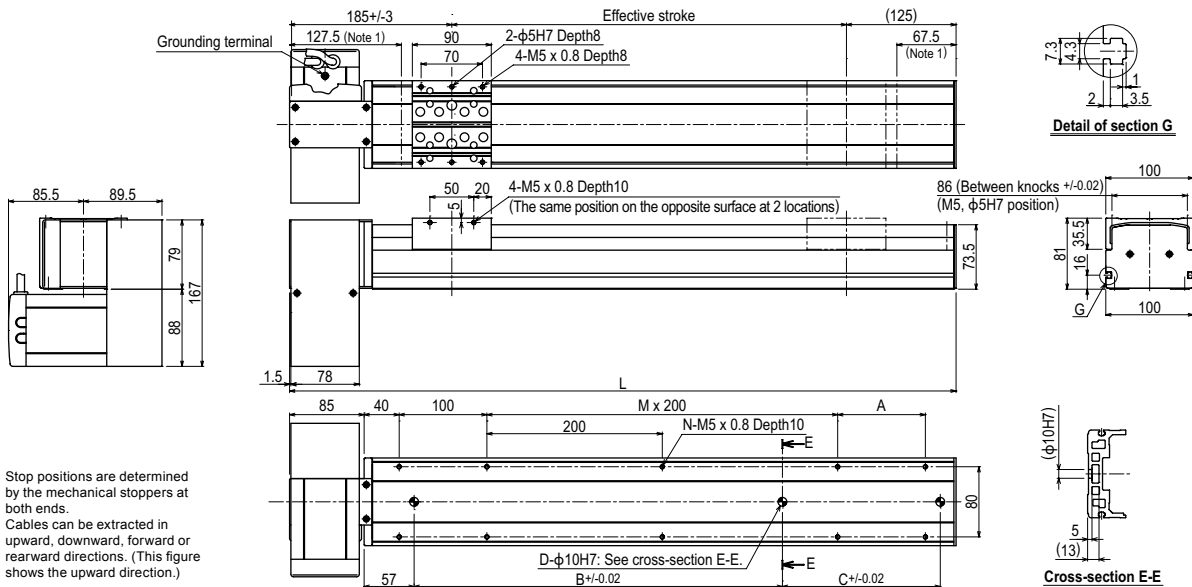

Note 1. Stop positions are determined by the mechanical stoppers at both ends.  
Note 2. Cables can be extracted in upward, downward, forward or rearward directions. (This figure shows the upward direction.)

B10 LU type (Motor leftward, upper position)

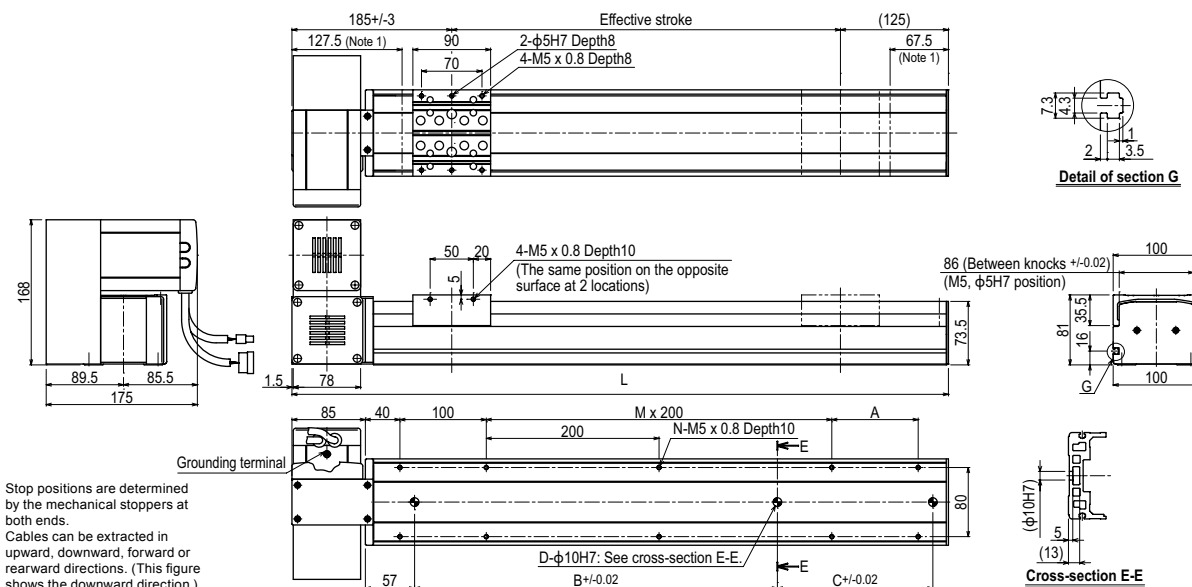

Note 1. Stop positions are determined by the mechanical stoppers at both ends.  
Note 2. Cables can be extracted in upward, downward, forward or rearward directions. (This figure shows the downward direction.)

# B14



## Ordering method

<b>B14</b>					<b>TSX</b>				
<b>Model</b>	<b>Motor installation direction</b> L: Motor leftward, horizontal position R: Motor rightward, horizontal position LU: Motor leftward, upper position RU: Motor rightward, upper position LD: Motor leftward, lower position RD: Motor rightward, lower position	<b>Option</b> Grease type None: Standard GC: Clean	<b>Stroke</b> 150 to 3050 (50mm pitch)	<b>Cable length<sup>Note 1</sup></b> 3L: 3.5m 5L: 5m 10L: 10m 3K/5K/10K (Flexible cable)	<b>Positioner<sup>Note 2</sup></b> TS-X	<b>Driver: Power supply voltage / Power capacity</b> 105: 100V/100W or less 205: 200V/100W or less	<b>LCD monitor</b> No entry: None L: With LCD	<b>I/O selection</b> NP: NPN PN: PNP CC: CC-Link DN: DeviceNet™ EP: EtherNet/IP™ PT: PROFINET GW: No I/O board <sup>Note 3</sup>	<b>Battery</b> B: With battery (Absolute) N: None (Incremental)
					<b>SR1-X</b>	<b>05</b>			
					<b>Controller</b>	<b>Driver: Power capacity</b> 05: 100W or less	<b>Usable for CE</b> No entry: Standard E: CE marking	<b>I/O selection</b> N: NPN P: PNP CC: CC-Link DN: DeviceNet™ PB: PROFIBUS	<b>Battery</b> B: With battery (Absolute) N: None (Incremental)
					<b>RDV-X</b>	<b>2</b>	<b>05</b>	<b>RBR1</b>	
					<b>Driver</b>	<b>Power supply voltage</b> 2: AC200V	<b>Driver: Power capacity</b> 05: 100W or less	<b>Regenerative unit</b>	

Note 1. The robot cable is standard cable (3L/5L/10L), but can be changed to flexible cable. See P.596 for details on robot cable.  
 Note 2. See P.500 for DIN rail mounting bracket.  
 Note 3. Select this selection when using the gateway function. For details, see P.62.

## Specifications

<b>AC servo motor output (W)</b>	100
<b>Repeatability<sup>Note 1</sup> (mm)</b>	+/-0.04
<b>Belt (mm)</b>	Equivalent to lead 25mm
<b>Maximum speed (mm/sec)</b>	1875
<b>Maximum payload (kg)</b>	20
<b>Stroke (mm)</b>	150 to 3050 (100mm pitch)
<b>Overall length (mm)</b>	Motor installation L/R type Another Stroke+425.5 Stroke+338
<b>Maximum dimensions of cross section of main unit (mm)</b>	W146 × H94
<b>Cable length (m)</b>	Standard: 3.5 / Option: 5.10
<b>Linear guide type</b>	4 rows of circular arc grooves × 2 rail
<b>Position detector</b>	Resolvers <sup>Note 2</sup>
<b>Resolution (Pulse/rotation)</b>	16384

Note 1. Positioning repeatability in one direction.  
 Note 2. Position detectors (resolvers) are common to incremental and absolute specifications. If the controller has a backup function then it will be absolute specifications.

## Allowable overhang<sup>Note</sup>

	Horizontal installation (Unit: mm)			Wall installation (Unit: mm)		
	A	B	C	A	B	C
5kg	2159	1228	943	1064	816	1468
10kg	1389	623	548	564	377	888
20kg	1102	320	348	305	156	615

Note. Distance from center of slider top to center of gravity of object being carried at a guide service life of 10,000 km.

## Static loading moment

(Unit: N·m)		
MY	MP	MR
226	227	199

## Controller

Controller	Operation method
SR1-X05 RCX221/222 RCX240/340	Programming / I/O point trace / Remote command / Operation using RS-232C communication
TS-X105 TS-X205	I/O point trace / Remote command
RDV-X205-RBR1	Pulse train control

## Motor installation The line-up consisting of six models of different motor installation position as follows.

<b>L type</b> Leftward at horizontal position	<b>R type</b> Rightward at horizontal position	<b>LU type</b> Leftward at upper position	<b>RU type</b> Rightward at upper position	<b>LD type</b> Leftward at lower position	<b>RD type</b> Rightward at lower position
---	--	---	--	---	--

## B14 R type (Motor rightward, horizontal position)

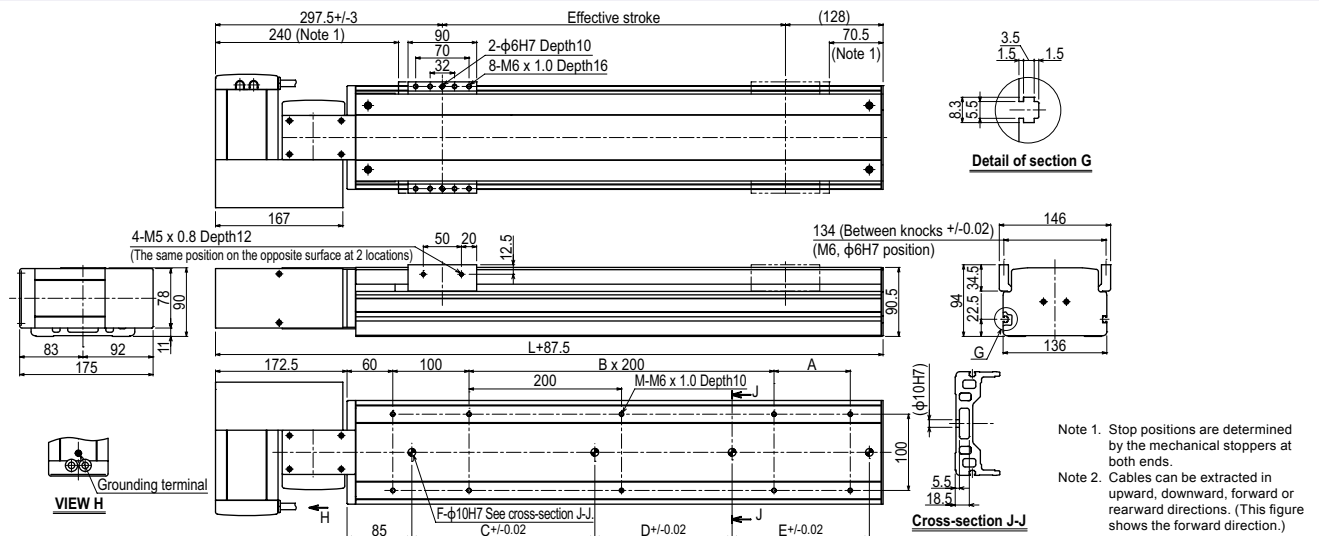

Note 1. Stop positions are determined by the mechanical stoppers at both ends.  
 Note 2. Cables can be extracted in upward, downward, forward or rearward directions. (This figure shows the forward direction.)

Effective stroke	150	200	250	300	350	400	450	500	550	600	650	700	750	800	850	900	950	1000	1050	1100	1150	1200	1250	1300	1350	1400	1450	1500	1550	1600	
L	488	538	588	638	688	738	788	838	888	938	988	1038	1088	1138	1188	1238	1288	1338	1388	1438	1488	1538	1588	1638	1688	1738	1788	1838	1888	1938	
M	6	8	8	8	8	10	10	10	10	12	12	12	12	14	14	14	16	16	16	16	16	18	18	18	18	20	20	20	20	22	
A	-	50	100	150	200	50	100	150	200	50	100	150	200	50	100	150	200	50	100	150	200	50	100	150	200	50	100	150	200	50	
B	1	1	1	1	1	2	2	2	2	3	3	3	3	4	4	4	5	5	5	5	5	6	6	6	6	7	7	7	7	8	
C	240	240	240	420	420	420	600	600	600	600	780	780	780	780	960	960	960	1140	1140	1140	1140	1140	1140	1140	1140	1140	1140	1140	1140	1140	
D	-	-	-	-	-	-	-	-	-	-	-	-	-	-	-	-	-	-	-	-	-	-	240	240	240	240	420	420	420	600	
E	-	-	-	-	-	-	-	-	-	-	-	-	-	-	-	-	-	-	-	-	-	-	-	-	-	-	-	-	-	-	-
F	2	2	2	2	2	2	2	2	2	2	2	2	2	2	2	2	2	2	2	2	2	2	2	2	2	2	2	2	2	2	
Weight (kg)	9.6	10.2	10.8	11.4	12	12.5	13.1	13.7	14.3	14.9	15.5	16.0	16.6	17.2	17.8	18.4	19	19.5	20.2	20.7	21.3	21.9	22.5	23.1	23.7	24.2	24.8	25.4	26	26.6	

Effective stroke	1650	1700	1750	1800	1850	1900	1950	2000	2050	2100	2150	2200	2250	2300	2350	2400	2450	2500	2550	2600	2650	2700	2750	2800	2850	2900	2950	3000	3050	
L	1988	2038	2088	2138	2188	2238	2288	2338	2388	2438	2488	2538	2588	2638	2688	2738	2788	2838	2888	2938	2988	3038	3088	3138	3188	3238	3288	3338	3388	
M	22	22	22	24	24	24	24	26	26	26	26	28	28	28	28	30	30	30	30	32	32	32	32	34	34	34	34	36	36	
A	100	150	200	50	100	150	200	50	100	150	200	50	100	150	200	50	100	150	200	50	100	150	200	50	100	150	200	50	100	
B	8	8	8	9	9	9	9	10	10	10	10	11	11	11	11	12	12	12	12	13	13	13	13	14	14	14	14	15	15	
C	1140	1140	1140	1140	1140	1140	1140	1140	1140	1140	1140	1140	1140	1140	1140	1140	1140	1140	1140	1140	1140	1140	1140	1140	1140	1140	1140	1140	1140	1140
D	600	600	600	780	780	780	780	960	960	960	960	960	960	1140	1140	1140	1140	1140	1140	1140	1140	1140	1140	1140	1140	1140	1140	1140	1140	1140
E	-	-	-	-	-	-	-	-	-	-	-	-	-	-	-	-	-	-	-	-	-	-	-	-	-	-	-	-	-	-
F	3	3	3	3	3	3	3	3	3	3	3	3	3	3	3	3	3	3	3	3	3	3	3	3	3	3	3	3	3	3
Weight (kg)	27.2	27.7	28.3	28.9	29.5	30.1	30.7	31.3	31.9	32.4	33	33.6	34.2	34.8	35.4	35.9	36.5	37.1	37.7	38.3	38.9	39.4	40	40.6	41.2	41.8	42.4	43.0	43.6	



B14 RU type (Motor rightward, upper position)

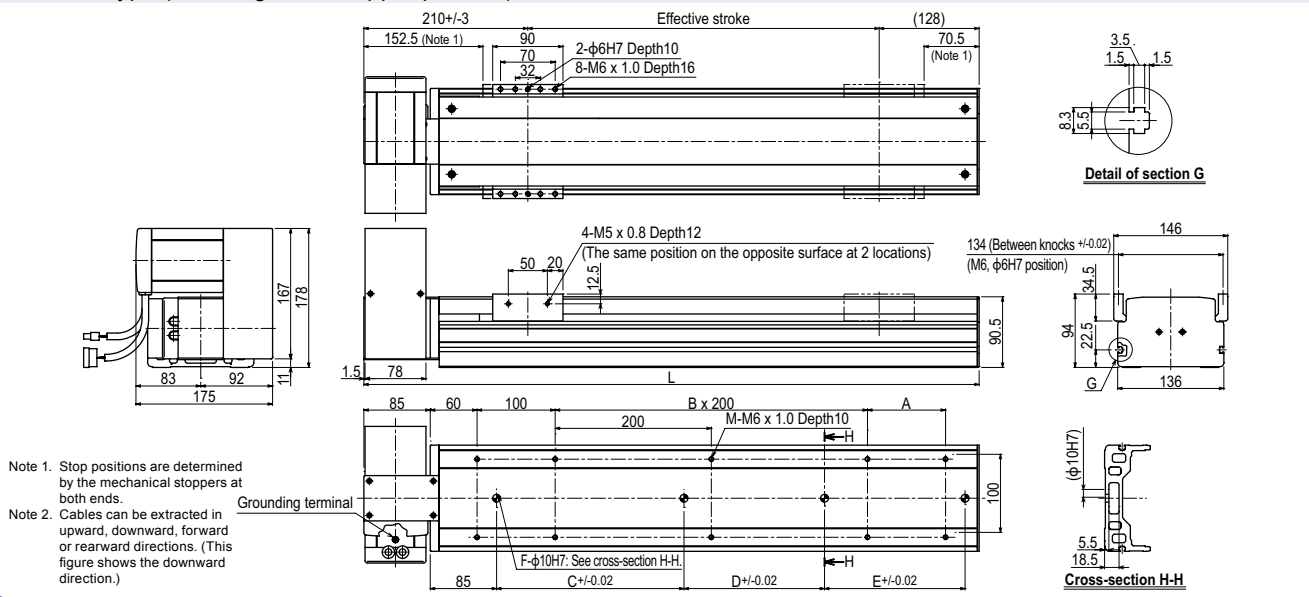

B14 RD type (Motor rightward, lower position)

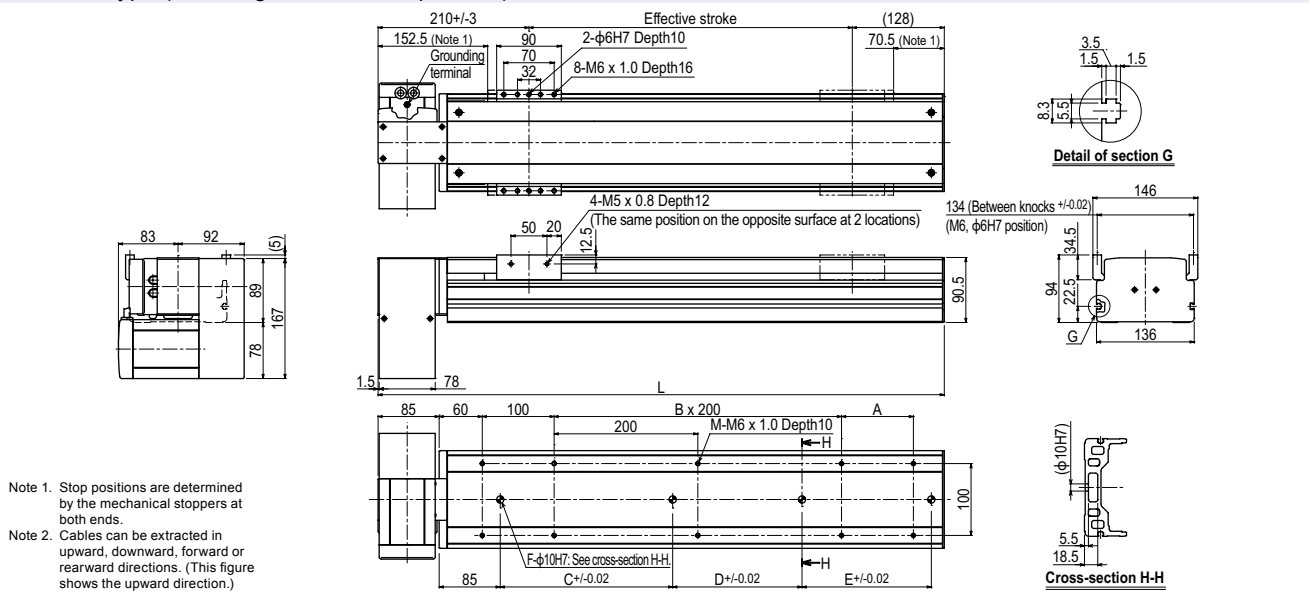

B14 LU type (Motor leftward, upper position)

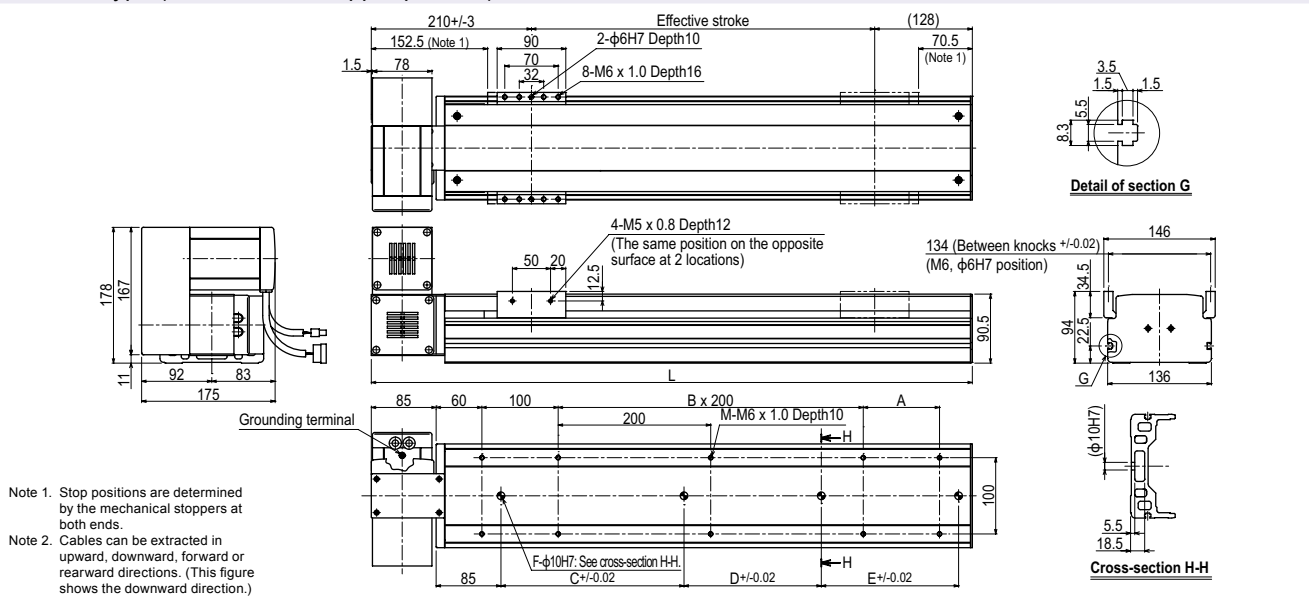

# B14H



## Ordering method

**B14H** - [ ] - [ ] - [ ] - [ ]

Model	Motor installation direction	Option	Stroke	Cable length (mm)	TSX	R	LCD monitor	I/O selection	Battery
	L: Motor leftward, horizontal position R: Motor rightward, horizontal position LU: Motor leftward, upper position RU: Motor rightward, upper position LD: Motor leftward, lower position RD: Motor rightward, lower position	Grease type None: Standard GC: Clean	150 to 3050 (50mm pitch)	3L: 3.5m 5L: 5m 10L: 10m 3K/5K/10K (Flexible cable)	Positioner <sup>Note 2</sup> TS-X Driver: Power-supply voltage / Power capacity 105: 100V/100W or less 205: 200V/100W or less	Regenerative unit R: With RGT	No entry: None L: With LCD	NP: NPN PN: PNP CC: CC-Link DN: DeviceNet™ EP: EtherNet/IP™ PT: PROFIBUS GW: No I/O board <sup>Note 3</sup>	B: With battery (Absolute) N: None (Incremental)

SR1-X	05	R	I/O selection	Battery
Controller	Driver: Power capacity 05: 100W or less	Usable for CE No entry: Standard E: CE marking	No: NPN P: PNP CC: CC-Link DN: DeviceNet™ EP: EtherNet/IP™ PB: PROFIBUS	B: With battery (Absolute) N: None (Incremental)

RDV-X	2	10	RBR1
Driver	Power-supply voltage 2: AC200V	Driver: Power capacity 10: 200W or less	Regenerative unit

Note 1. The robot cable is standard cable (3L/5L/10L), but can be changed to flexible cable. See P.596 for details on robot cable.  
 Note 2. See P.500 for DIN rail mounting bracket.  
 Note 3. Select this selection when using the gateway function. For details, see P.62.

## Specifications

AC servo motor output (W)	200
Repeatability <sup>Note 1</sup> (mm)	+/-0.04
Belt (mm)	Equivalent to lead 25mm
Maximum speed (mm/sec)	1250 (1875 <sup>Note 2</sup> )
Maximum payload (kg)	30
Stroke (mm)	150 to 3050(100mm pitch)
Overall length (mm)	Motor installation L/R type Another Stroke+475.5 Stroke+388
Maximum dimensions of cross section of main unit (mm)	W146 x H94
Cable length (m)	Standard: 3.5 / Option: 5,10
Linear guide type	4 rows of circular arc grooves x 2 rail
Position detector	Resolvers <sup>Note 3</sup>
Resolution (Pulse/rotation)	16384

Note 1. Positioning repeatability in one direction.  
 Note 2. A regenerative unit is needed if using the SR1-X, TS-X at maximum speeds exceeding 1250mm/sec. If using the RDV-X, then the regenerative unit RBR1 is required regardless of the installation conditions.  
 Note 3. Position detectors (resolvers) are common to incremental and absolute specifications. If the controller has a backup function then it will be absolute specifications.

## Allowable overhang<sup>Note</sup>

Horizontal installation (Unit: mm)	Horizontal installation (Unit: mm)			Wall installation (Unit: mm)		
	A	B	C	A	B	C
5kg	3000	3000	1941	2074	2585	3000
10kg	2742	1697	1064	1087	1236	2071
20kg	2158	867	651	604	561	1512
30kg	1708	590	466	397	336	1106

Note. Distance from center of slider top to center of gravity of object being carried at a guide service life of 10,000 km.

## Static loading moment

(Unit: N·m)		
MY	MP	MR
610	555	488

## Controller

Controller	Operation method
SR1-X05 <sup>Note</sup> RCX221/222 RCX240/340	Programming / I/O point trace / Remote command / Operation using RS-232C communication
TS-X105 <sup>Note</sup> TS-X205 <sup>Note</sup>	I/O point trace / Remote command
RDV-X210-RBR1	Pulse train control

Note. A regenerative unit is needed if using the SR1-X, TS-X at maximum speeds exceeding 1250mm/sec.

## Motor installation The line-up consisting of six models of deferent motor installation position as follows.

<b>L type</b> Leftward at horizontal position	<b>R type</b> Rightward at horizontal position	<b>LU type</b> Leftward at upper position	<b>RU type</b> Rightward at upper position	<b>LD type</b> Leftward at lower position	<b>RD type</b> Rightward at lower position
---	--	---	--	---	--

## B14H R type (Motor rightward, horizontal position)

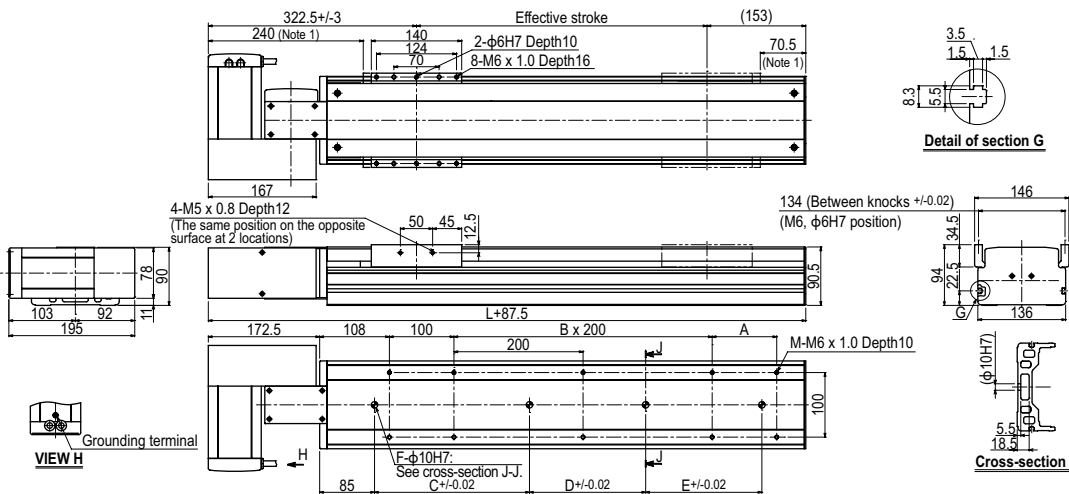

Note 1. Stop positions are determined by the mechanical stoppers at both ends.  
 Note 2. Cables can be extracted in upward, downward, forward or rearward directions. (This figure shows the forward direction.)

Effective stroke	150	200	250	300	350	400	450	500	550	600	650	700	750	800	850	900	950	1000	1050	1100	1150	1200	1250	1300	1350	1400	1450	1500	1550	1600
L	538	588	638	688	738	788	838	888	938	988	1038	1088	1138	1188	1238	1288	1338	1388	1438	1488	1538	1588	1638	1688	1738	1788	1838	1888	1938	1988
M	6	8	8	8	8	10	10	10	12	12	12	14	14	14	16	16	16	16	16	16	16	18	18	18	18	18	20	20	20	22
A	-	50	100	150	200	50	100	150	200	50	100	150	200	50	100	150	200	50	100	150	200	50	100	150	200	50	100	150	200	50
B	1	1	1	1	2	2	2	2	3	3	3	4	4	4	4	5	5	5	5	5	5	6	6	6	6	7	7	7	8	
C	240	240	420	420	420	600	600	600	600	780	780	780	780	960	960	960	1140	1140	1140	1140	1140	1140	1140	1140	1140	1140	1140	1140	1140	
D	-	-	-	-	-	-	-	-	-	-	-	-	-	-	-	-	-	-	-	-	-	240	240	240	240	420	420	420	600	600
E	-	-	-	-	-	-	-	-	-	-	-	-	-	-	-	-	-	-	-	-	-	-	-	-	-	-	-	-	-	-
F	2	2	2	2	2	2	2	2	2	2	2	2	2	2	2	2	2	2	2	2	2	2	2	2	2	2	2	2	2	2
Weight (kg)	10.9	11.5	12.1	12.7	13.2	13.9	14.4	15.0	15.6	16.2	16.7	17.4	17.9	18.5	19.1	19.7	20.2	20.9	22.0	22.1	22.6	23.3	23.8	24.4	24.9	25.6	26.1	26.8	27.3	27.9

  

Effective stroke	1650	1700	1750	1800	1850	1900	1950	2000	2050	2100	2150	2200	2250	2300	2350	2400	2450	2500	2550	2600	2650	2700	2750	2800	2850	2900	2950	3000	3050
L	2038	2088	2138	2188	2238	2288	2338	2388	2438	2488	2538	2588	2638	2688	2738	2788	2838	2888	2938	2988	3038	3088	3138	3188	3238	3288	3338	3388	3438
M	22	22	22	24	24	24	24	26	26	26	26	28	28	28	28	30	30	30	30	32	32	32	34	34	34	34	34	36	36
A	100	150	200	50	100	150	200	50	100	150	200	50	100	150	200	50	100	150	200	50	100	150	200	50	100	150	200	50	100
B	8	8	8	9	9	9	9	10	10	10	10	11	11	11	11	12	12	12	12	13	13	13	14	14	14	14	14	15	15
C	1140	1140	1140	1140	1140	1140	1140	1140	1140	1140	1140	1140	1140	1140	1140	1140	1140	1140	1140	1140	1140	1140	1140	1140	1140	1140	1140	1140	1140
D	600	600	780	780	780	960	960	960	960	1140	1140	1140	1140	1140	1140	1140	1140	1140	1140	1140	1140	1140	1140	1140	1140	1140	1140	1140	1140
E	-	-	-	-	-	-	-	-	-	-	-	-	-	-	-	240	240	240	420	420	420	420	420	600	600	600	780	780	960
F	3	3	3	3	3	3	3	3	3	3	3	3	3	3	3	4	4	4	4	4	4	4	4	4	4	4	4	4	4
Weight (kg)	28.4	29.1	29.6	30.3	30.8	31.4	31.9	32.6	33.1	33.8	34.3	35.0	35.5	36.1	36.6	37.3	37.8	38.5	39.0	39.6	40.1	40.8	41.3	42.0	42.5	43.1	43.6	44.3	45.4

## B14H RU type (Motor rightward, upper position)

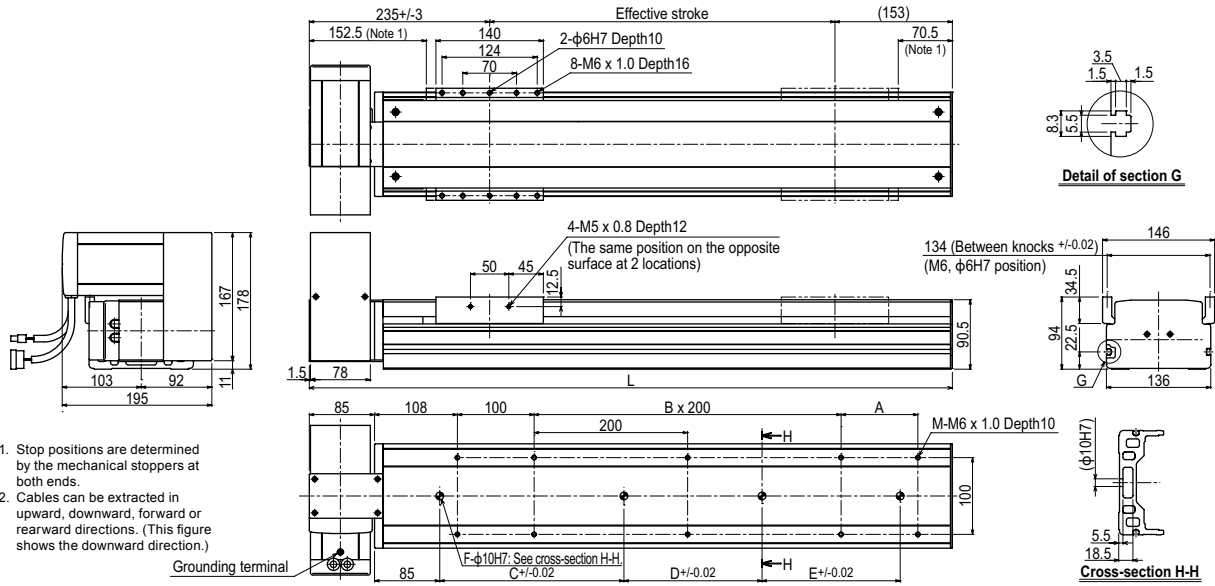

## B14H RD type (Motor rightward, lower position)

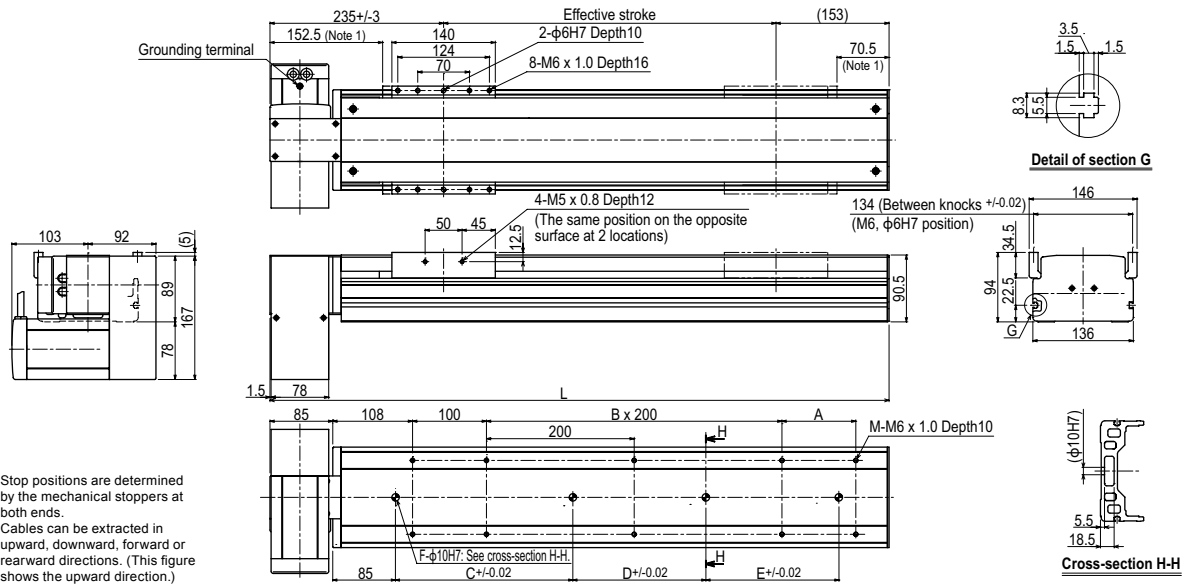

## B14H LU type (Motor leftward, upper position)

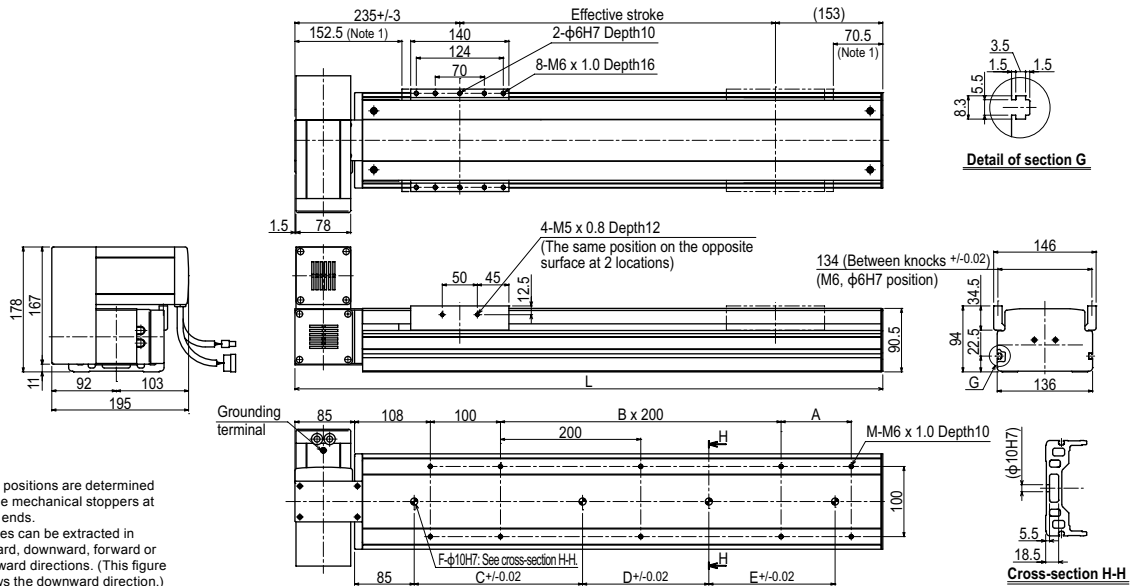

# R5



## Ordering method

### R5

Model	Cable entry location	Cable length <sup>Note 1</sup>
	No entry: Standard (S) B: From the side	3L: 3.5m 5L: 5m 10L: 10m 3K/5K/10K (Flexible cable)

### TSX

Positioner <sup>Note 2</sup>	Driver: Power-supply voltage / Power capacity	LCD monitor	I/O selection	Battery
TS-X	105: 100V/100W or less 205: 200V/100W or less	No entry: None L: With LCD	NP: NPN PN: PNP CC: CC-Link DN: DeviceNet™ EP: EtherNet/IP™ PT: PROFINET GW: No I/O board <sup>Note 3</sup>	B: With battery (Absolute) N: None (Incremental)

### SR1-X

Controller	05	Usable for CE	I/O selection	Battery
	Driver: Power capacity 05: 100W or less	No entry: Standard E: CE marking	N: NPN P: PNP CC: CC-Link DN: DeviceNet™ PB: PROFIBUS	B: With battery (Absolute) N: None (Incremental)

### RDV-X

Driver	2	05	RBR1
	Power-supply voltage 2: AC200V	Driver: Power capacity 05: 100W or less	Regenerative unit

Note 1. The robot cable is standard cable (3L/5L/10L), but can be changed to flexible cable. See P.596 for details on robot cable.  
Note 2. See P.500 for DIN rail mounting bracket.  
Note 3. Select this selection when using the gateway function. For details, see P.62.

## Specifications

AC servo motor output (W)	50
Repeatability (°)	+/-0.0083
Maximum speed (°/sec)	360
Maximum allowable moment inertia (kgm <sup>2</sup> [kgfcm <sup>2</sup> ])	0.12 [1.2]
Rated torque (Nm[kgfm])	5.29 [0.54]
Speed reduction ratio	1/50
Rotation range (°)	360
Cable length (m)	Standard: 3.5 / Option: 5.10
Speed reducer type	Harmonic drive
Position detector	Resolvers
Resolution (Pulse/rotation)	16384

## Maximum allowable moment inertia

Payload parameters W (kg)	1	2	3	4	5	6	7	8	9	10
Maximum allowable moment inertia J (kgfcm <sup>2</sup> )	0.12	0.24	0.36	0.48	0.60	0.72	0.84	0.96	1.08	1.20

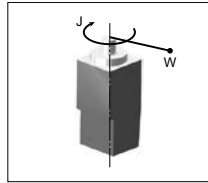

Note. When the weight of a tool or workpiece attached to the shaft R5 is W (kg), its moment of inertia (J) must be smaller than the values shown in the table above. (For example, enter 4kg if W is 3kg and J is 0.48kgf cm sec<sup>2</sup>) Enter the above mass parameter value for the controller, and optimum acceleration is automatically set based on this value.

Note. For calculation (equation) of the inertia moment, please refer to P.613.

## Controller

Controller	Operation method
SR1-X05 RCX221/222 RCX240/340	Programming / I/O point trace / Remote command / Operation using RS-232C communication
TS-X105	I/O point trace / Remote command
TS-X205	Remote command
RDV-X205-RBR1	Pulse train control

## R5

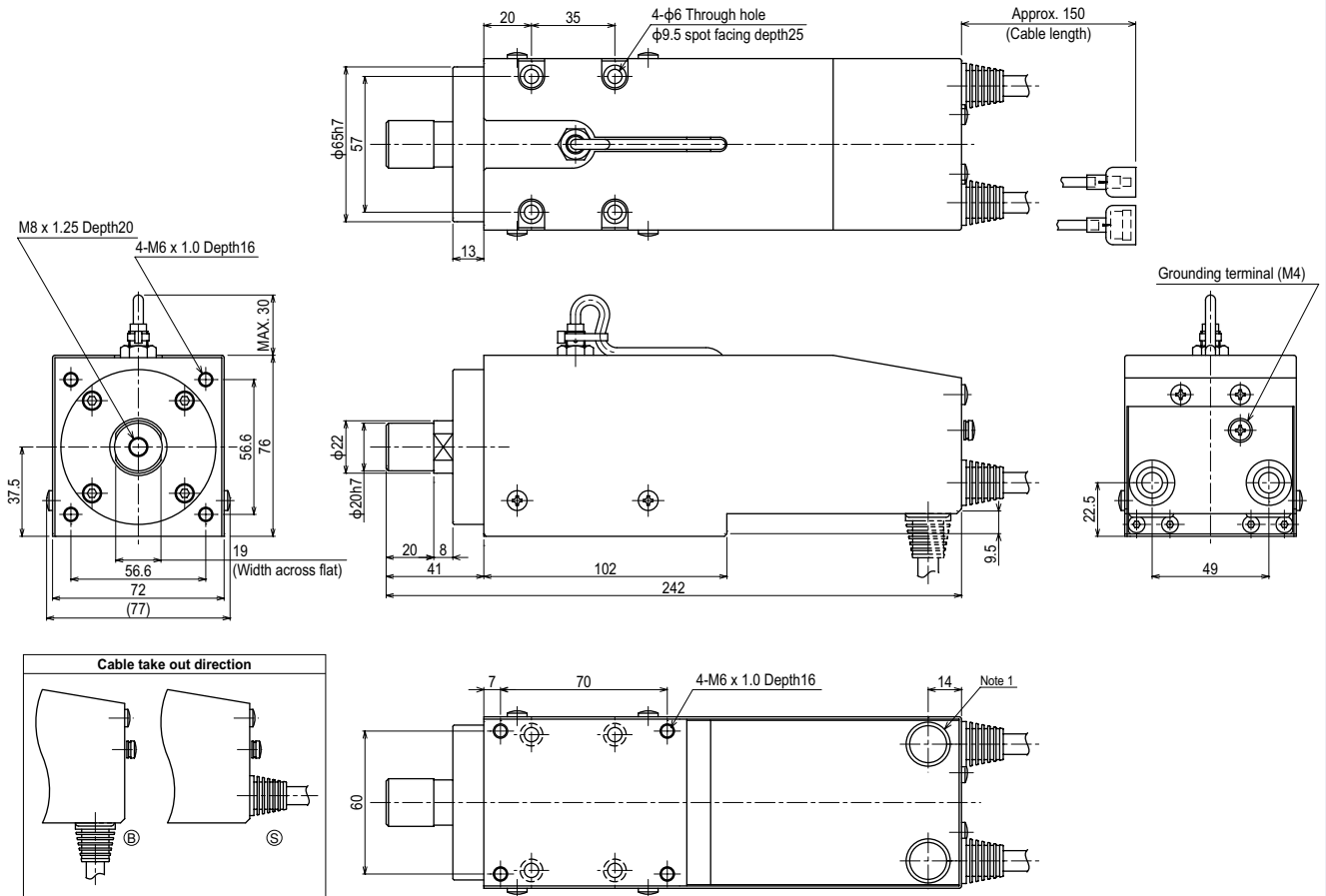

Weight (kg) 3.0 Note 1. The cable extraction port can be changed.

# R10



## Ordering method

<b>R10</b>	<b>Model</b>	<b>Cable entry location</b> No entry: Standard (S) B: From the side	<b>Cable length</b> <sup>Note 1</sup> 3L: 3.5m 5L: 5m 10L: 10m 3K/5K/10K (Flexible cable)	<b>TSX</b>	<b>Positioner</b> <sup>Note 2</sup> TS-X	<b>Driver: Power-supply voltage / Power capacity</b> 105: 100V/100W or less 205: 200V/100W or less	<b>LCD monitor</b> No entry: None L: With LCD	<b>I/O selection</b> NP: NPN PN: PNP CC: CC-Link DN: DeviceNet™ EP: EtherNet/IP™ PT: PROFINET GW: No I/O board <sup>Note 3</sup>	<b>Battery</b> B: With battery (Absolute) N: None (Incremental)
	<b>SR1-X</b>	<b>Controller</b>	<b>05</b>	<b>Driver: Power capacity</b> 05: 100W or less	<b>Usable for CE</b> No entry: Standard E: CE marking	<b>I/O selection</b> N: NPN P: PNP CC: CC-Link DN: DeviceNet™ PB: PROFIBUS	<b>Battery</b> B: With battery (Absolute) N: None (Incremental)		
	<b>RDV-X</b>	<b>Driver</b>	<b>2</b>	<b>Power-supply voltage</b> 2: AC200V	<b>05</b>	<b>Driver: Power capacity</b> 05: 100W or less	<b>RBR1</b>	<b>Regenerative unit</b>	

Note 1. The robot cable is standard cable (3L/5L/10L), but can be changed to flexible cable.  
See P.596 for details on robot cable.  
Note 2. See P.500 for DIN rail mounting bracket.  
Note 3. Select this selection when using the gateway function. For details, see P.62.

## Specifications

AC servo motor output (W)	100
Repeatability (°)	+/-0.0083
Maximum speed (°/sec)	360
Maximum allowable moment inertia (kgm <sup>2</sup> [kgfcm <sup>2</sup> ])	0.36 [3.71]
Rated torque (Nm[kgfm])	10.78 [1.10]
Speed reduction ratio	1/50
Rotation range (°)	360
Cable length (m)	Standard: 3.5 / Option: 5.10
Speed reducer type	Harmonic drive
Position detector	Resolvers
Resolution (Pulse/rotation)	16384

## Maximum allowable moment inertia

Payload parameters W (kg)	1	2	3	4	5	6	7	8	9	10
Maximum allowable moment inertia J (kgfcm <sup>2</sup> )	0.25	0.49	0.74	0.99	1.24	1.48	1.73	1.98	2.23	2.47
Payload parameters W (kg)	11	12	13	14	15					
Maximum allowable moment inertia J (kgfcm <sup>2</sup> )	2.72	2.97	3.22	3.46	3.71					

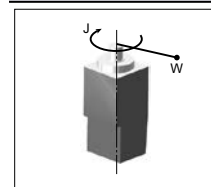

Note. When the weight of a tool or workpiece attached to the shaft R10 is W (kg), its moment of inertia (J) must be smaller than the values shown in the table above. (For example, enter 4kg if W is 3kg and J is 0.99kgf cm sec<sup>2</sup>.) Enter the above mass parameter value for the controller, and optimum acceleration is automatically set based on this value.

Note. For calculation (equation) of the inertia moment, please refer to P.613.

## Controller

Controller	Operation method
SR1-X05 RCX221/222 RCX240/340	Programming / I/O point trace / Remote command / Operation using RS-232C communication
TS-X105	I/O point trace / Remote command
TS-X205	Remote command
RDV-X205-RBR1	Pulse train control

## R10

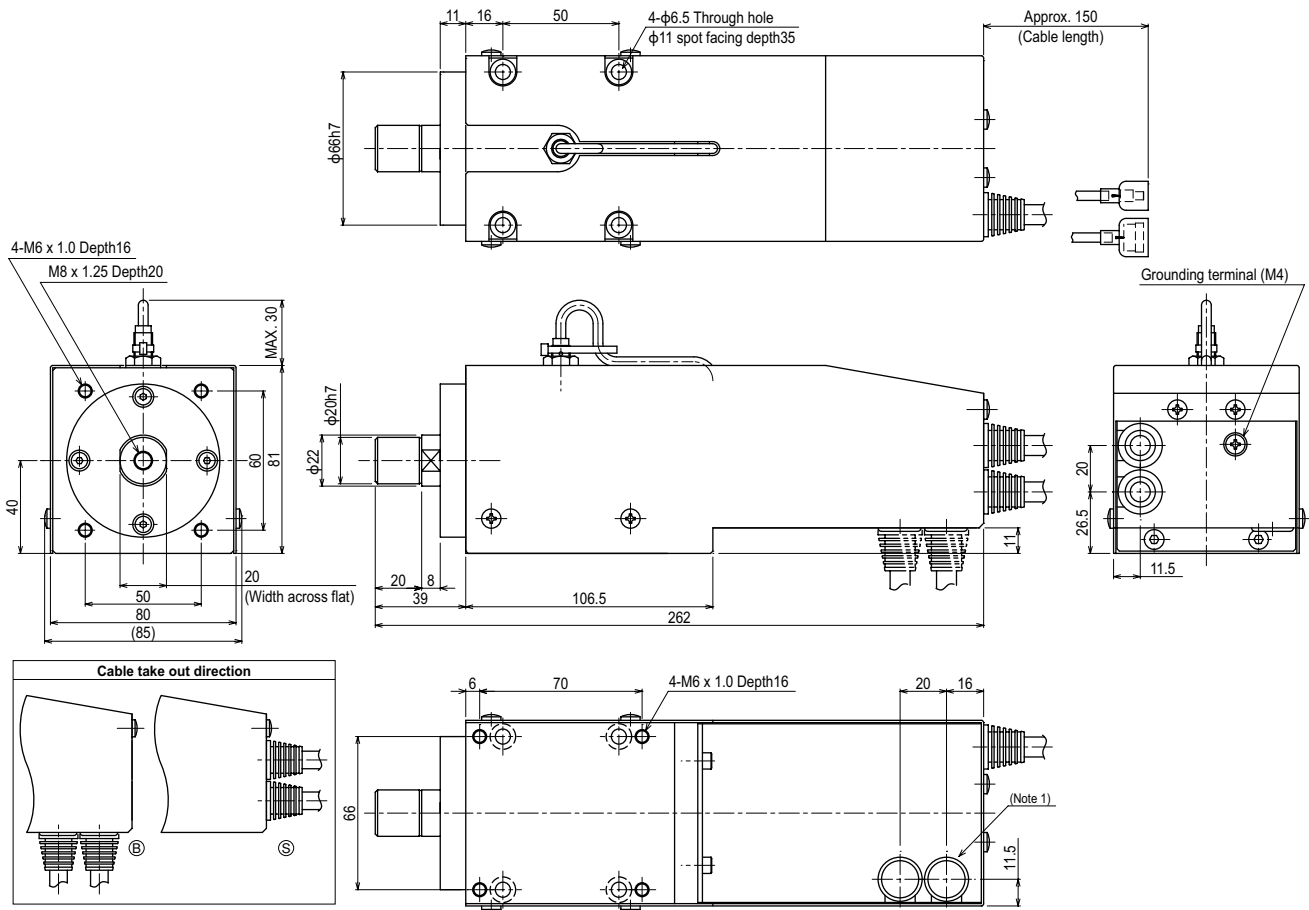

Weight (kg) 3.5 Note 1. The cable extraction port can be changed.

Articulated robots  
YA

Linear conveyor modules  
LCM100

Compact single-axis robots  
TRANSEVO

Single-axis robots  
FLIP-X

Linear motor single-axis robots  
PHASER

Cartesian robots  
XY-X

SCARA robots  
YK-X

Pick & place robots  
YP-X

CLEAN

CONTROLLER INFORMATION

T type

F type

GF type

N type

R type

# R20



## Ordering method

<b>R20</b>	<b>Model</b>	<b>Cable entry location</b> No entry: Standard (S) B: From the side	<b>Cable length</b> <sup>Note 1</sup> 3L: 3.5m 5L: 5m 10L: 10m 3K/5K/10K (Flexible cable)	<b>TSX</b>	<b>Positioner</b> <sup>Note 2</sup> TS-X	<b>Driver: Power-supply voltage / Power capacity</b> 110: 100V/200W or less 210: 200V/200W or less	<b>LCD monitor</b> No entry: None L: With LCD	<b>I/O selection</b> NP: NPN PN: PNP CC: CC-Link DN: DeviceNet™ EP: EtherNet/IP™ PT: PROFINET GW: No I/O board <sup>Note 3</sup>	<b>Battery</b> B: With battery (Absolute) N: None (Incremental)
	<b>SR1-X</b>	<b>Controller</b>	<b>10</b>	<b>Driver: Power capacity</b> 10: 200W or less	<b>Usable for CE</b> No entry: Standard E: CE marking	<b>I/O selection</b> N: NPN P: PNP CC: CC-Link DN: DeviceNet™ PB: PROFIBUS	<b>Battery</b> B: With battery (Absolute) N: None (Incremental)		
	<b>RDV-X</b>	<b>Driver</b>	<b>2</b>	<b>Power-supply voltage</b> 2: AC200V	<b>10</b>	<b>Driver: Power capacity</b> 10: 200W or less	<b>RBR1</b>	<b>Regenerative unit</b>	

Note 1. The robot cable is standard cable (3L/5L/10L), but can be changed to flexible cable.  
See P.596 for details on robot cable.  
Note 2. See P.500 for DIN rail mounting bracket.  
Note 3. Select this selection when using the gateway function. For details, see P.62.

## Specifications

<b>AC servo motor output (W)</b>	200
<b>Repeatability (°)</b>	+/-0.0083
<b>Maximum speed (°/sec)</b>	360
<b>Maximum allowable moment inertia (kgm<sup>2</sup>[kgfcm<sup>2</sup>])</b>	1.83 [18.7]
<b>Rated torque (Nm[kgfm])</b>	21.46 [2.19]
<b>Speed reduction ratio</b>	1/50
<b>Rotation range (°)</b>	360
<b>Cable length (m)</b>	Standard: 3.5 / Option: 5,10
<b>Speed reducer type</b>	Harmonic drive
<b>Position detector</b>	-
<b>Resolution (Pulse/rotation)</b>	16384

## Maximum allowable moment inertia

<b>Payload parameters W (kg)</b>	1	2	3	4	5	6	7	8	9	10
<b>Maximum allowable moment inertia J (kgfcm<sup>2</sup>)</b>	0.93	1.8	2.8	3.7	4.6	5.6	6.5	7.4	8.4	9.3
<b>Payload parameters W (kg)</b>	11	12	13	14	15	16	17	18	19	20
<b>Maximum allowable moment inertia J (kgfcm<sup>2</sup>)</b>	10.2	11.2	12.1	13.1	14	14.9	15.9	16.8	17.7	18.7

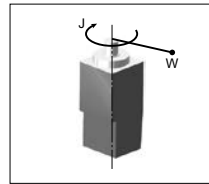

Note. When the weight of a tool or workpiece attached to the shaft R20 is W (kg), its moment of inertia (J) must be smaller than the values shown in the table above. (For example, enter 4kg if W is 3kg and J is 3.7kgf cm sec<sup>2</sup>.) Enter the above mass parameter value for the controller, and optimum acceleration is automatically set based on this value.

Note. For calculation (equation) of the inertia moment, please refer to P.613.

## Controller

Controller	Operation method
SR1-X10 RCX221/222 RCX240/340	Programming / I/O point trace / Remote command / Operation using RS-232C communication
TS-X110	I/O point trace / Remote command
TS-X210	Remote command
RDV-X210-RBR1	Pulse train control

## R20

