

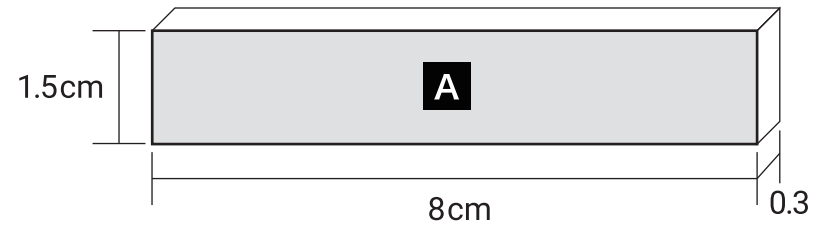

コンロッド部分のパーツ

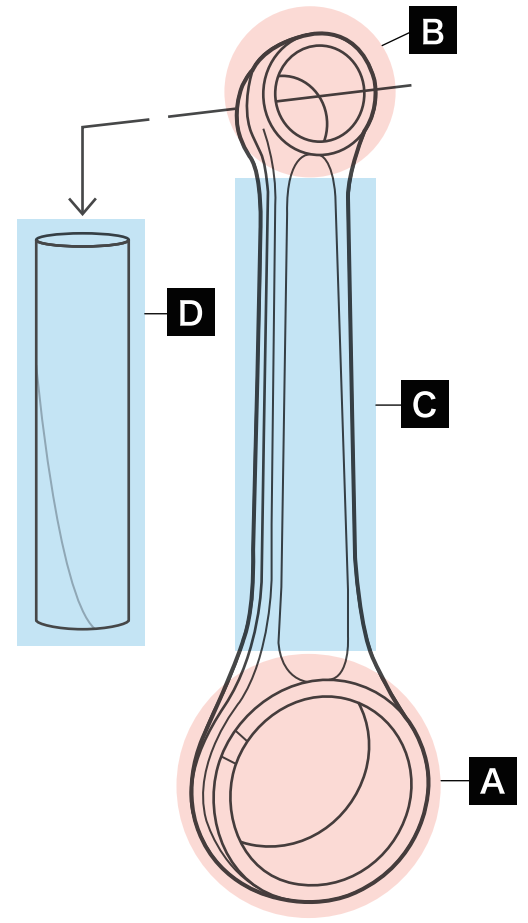

※3つ用意します

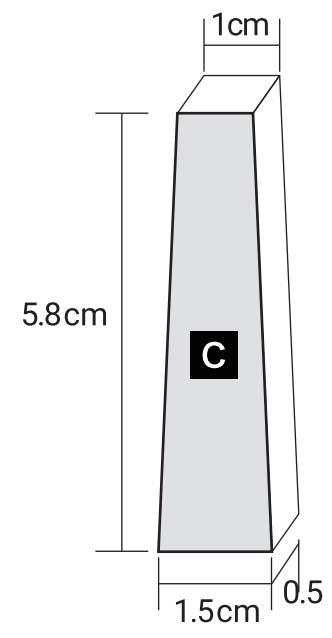
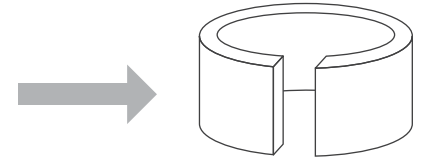
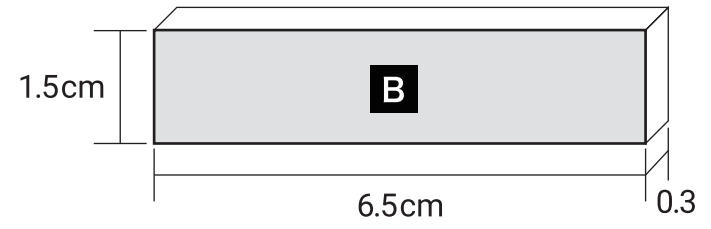

へり付け断面図

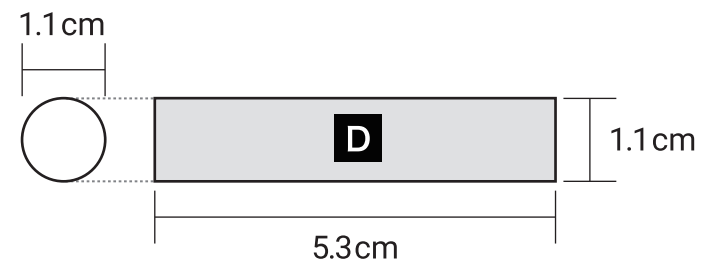
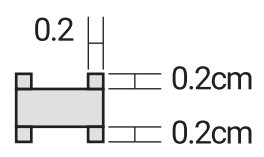

グラデーション参考写真





ピストンスカート部分のパーツ

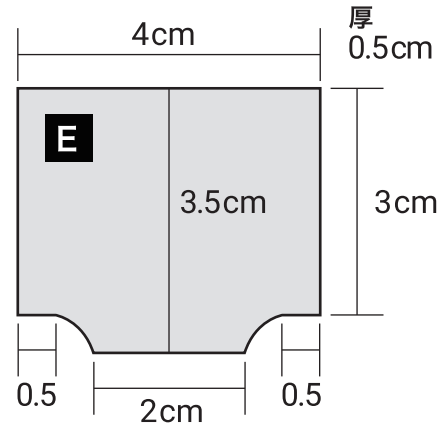
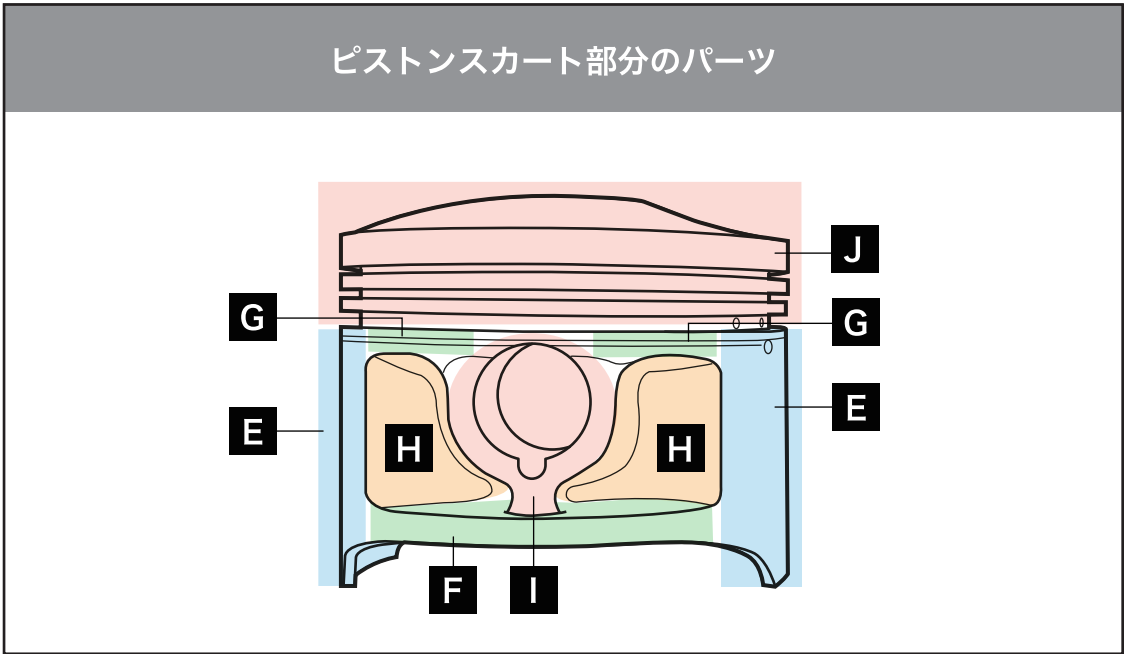

※2つ用意します

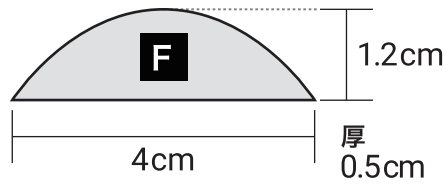

※2つ用意します

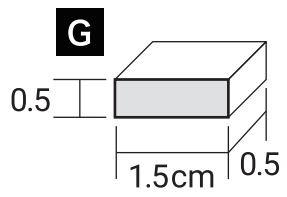

※4つ用意します

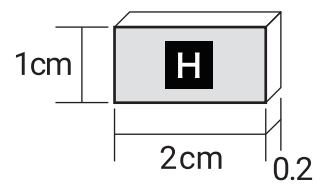

※4つ用意します

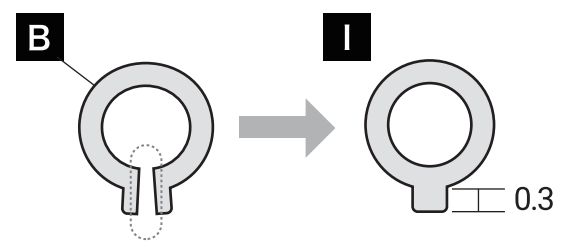

点線部分をつまみながら刺して着けます

※2つ用意します





J

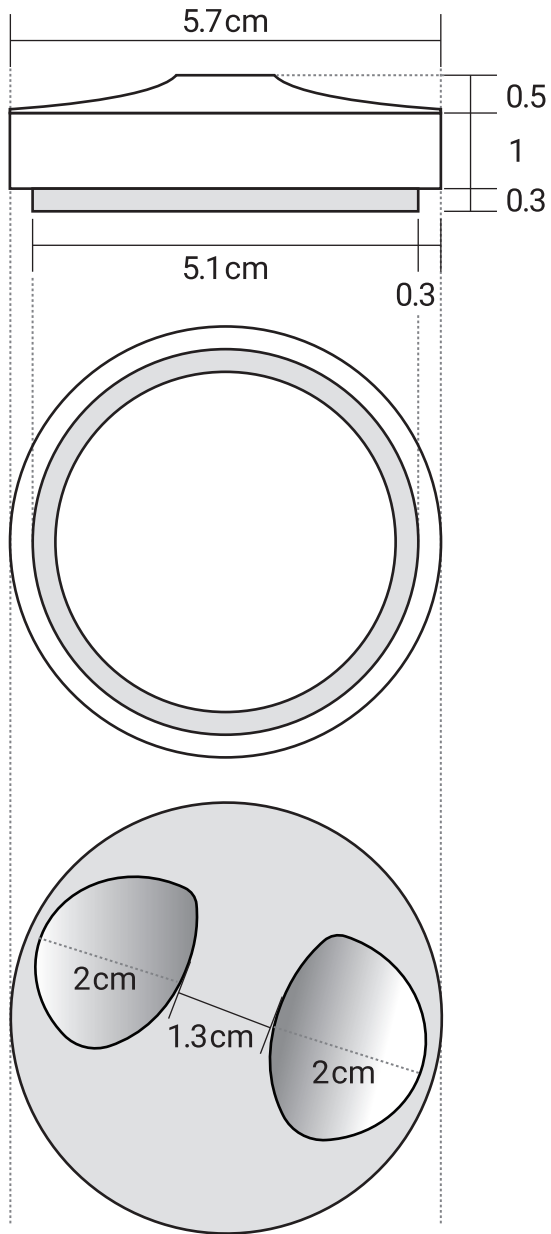

展開図

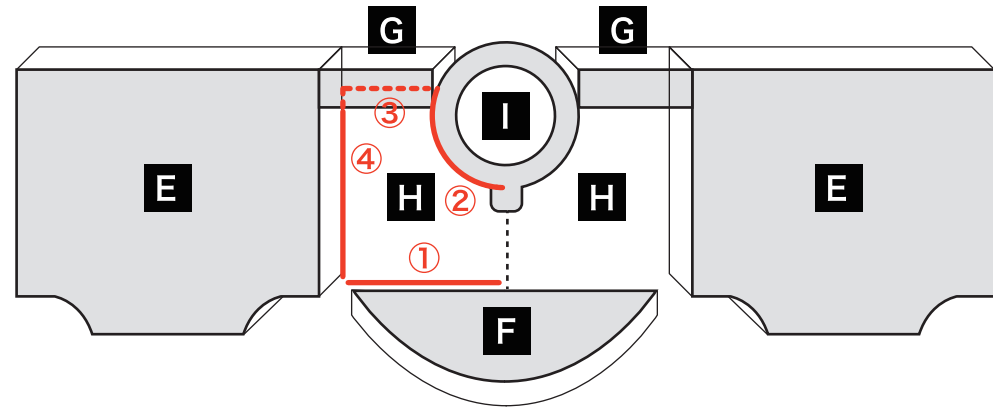

色指定

J

