

# FACT BOOK 2012

## Contents

---

### Corporate Section

- 2 Corporate Profile
- 2 Corporate Philosophy (Corporate Mission/Management Principles/Action Guidelines)
- 3 Operating Performance
- 3 Sales Breakdown by Business
- 3 Sales Breakdown by Region
- 4 Organization
- 5 Board of Directors, Corporate Auditors and Executive Officers
- 6 Group Companies
- 7 History
- 8 Number of Employees / Number of Recruited Graduates

### Product Business Section

- 10 Motorcycles
- 13 Boats
- 14 Marine Engines
- 16 Personal Watercraft
- 17 Swimming Pools
- 18 All-Terrain Vehicles & Side-by-Side Vehicles
- 19 Snowmobiles
- 20 Golf Cars
- 21 Generators
- 21 Snow Throwers
- 22 Electrically Power Assisted Bicycles
- 24 Electric Wheelchairs
- 25 Industrial Machinery and Robots
- 26 Automobile Engines
- 27 Industrial-use Unmanned Helicopters
- 26 Other Products

# FACT BOOK 2012 Corporate Section

## Corporate Profile

Corporate name:	Yamaha Motor Co., Ltd.
Founded:	July 1, 1955
Headquarters:	2500, Shingai, Iwata, Shizuoka 438-8501, Japan
President:	Hiroyuki Yanagi
Capital:	85,666 million yen (as of Dec 31, 2011)
Number of shares	Authorized: 900,000,000 Issued: 349,757,784 (as of Dec 31, 2011)
Number of employees:	Consolidated basis: 54,677 Non-consolidated basis: 10,159 (as of Dec 31, 2011)
Group companies:	Number of consolidated subsidiaries: 107 (Japan: 25 Overseas: 82) Number of non-consolidated subsidiaries accounted for by the equity method: 6 Number of non-consolidated affiliates accounted for by the equity method: 25 (as of Dec 31, 2011)
Lines of business:	Manufacture and sales of motorcycles, scooters, electrically power assisted bicycles, boats, sailboats, personal watercraft, pools, utility boats, fishing boats, outboard motors, diesel engines, 4-wheel ATVs, side-by-side vehicles, racing kart engines, golf cars, multi-purpose engines, generators, water pumps, snowmobiles, small-sized snow throwers, automobile engines, surface mounters, intelligent machinery, industrial-use unmanned helicopters, electrical power units for wheel-chairs, helmets. Import and sales of various types of products, development of tourist businesses and management of leisure, recreational facilities and related services.



Yamaha Motor Co., Ltd.

## Corporate Mission

### Kando\* Creating Company

Offering new excitement and a more fulfilling life for people all over the world  
Yamaha Motor strives to realize peoples' dreams with ingenuity and passion, and to always be a company people look to for the next exciting product or concept that provides exceptional value and deep satisfaction.

\*Kando is a Japanese word for the simultaneous feelings of deep satisfaction and intense excitement that we experience when we encounter something of exceptional value.

## Management Principles

### 1. Creating value that surpasses customer expectations

To continue to produce value that moves people, we must remain keenly aware of the customer's evolving needs.  
We must strive to find success by always surpassing customer expectations with safe, high-quality products and services.

### 2. Establishing a corporate environment that fosters self-esteem

We must build a corporate culture that encourages enterprise and enhances corporate vitality.  
The focus will be on nurturing the creativity and ability of our employees, with an equitable system of evaluation and rewards.

### 3. Fulfilling social responsibilities globally

As a good corporate citizen, we act from a worldwide perspective and in accordance with global standards.  
We must conduct our corporate activities with concern for the environment and communities and fulfill our social responsibility with honesty and sincerity.

## Action Guidelines

Acting with Speed	Meeting change with swift and informed action
Spirit of Challenge	Courage to set higher goals without fear of failure
Persistence	Working with tenacity to achieve desired results, and then evaluating them

## Operating Performance (Consolidated Basis)

(Unit: billion ¥, rounded off to one decimal place)

	FY2009	FY2010	FY2011	FY2012 (plan)
Net sales			1,276.2	1,400.0
Operating income (loss)	62.6	51.3	53.4	45.0
Ordinary income	(68.3)	66.1	63.5	47.0
Net income (loss)	(216.1)	18.3	27.0	17.0
Exchange rate (USD)	94 JPY	88 JPY	80 JPY	77 JPY
Exchange rate (EUR)	130 JPY	116 JPY	111 JPY	100 JPY
Capital expenditures	46.0	33.9	45.0	69.0
Depreciation expenses	53.7	36.6	33.6	39.0
Research and development expenses	62.1	55.2	65.0	71.0
Equity ratio	21.5%	28.0%	31.2%	30.0%
Interest-bearing debt	399.9	322.4	274.7	300.0
Debt/equity ratio (gross)	1.88	1.18	0.98	1.0
Cash and cash equivalents at the end of the year	137.2	203.9	133.6	-
Percentage of overseas sales	88.7%	89.0%	88.5%	89.3%
Percentage of motorcycle business sales	70.8%	70.0%	69.5%	71.1%
Net cash provided by (used in) operating activities	74.1	104.5	33.3	-
Net cash provided by (used in) investing activities	(45.3)	(37.6)	(46.5)	-
Net cash provided by (used in) financing activities	(32.0)	5.3	(51.9)	-

## Sales Breakdown by Business (Consolidated Basis)

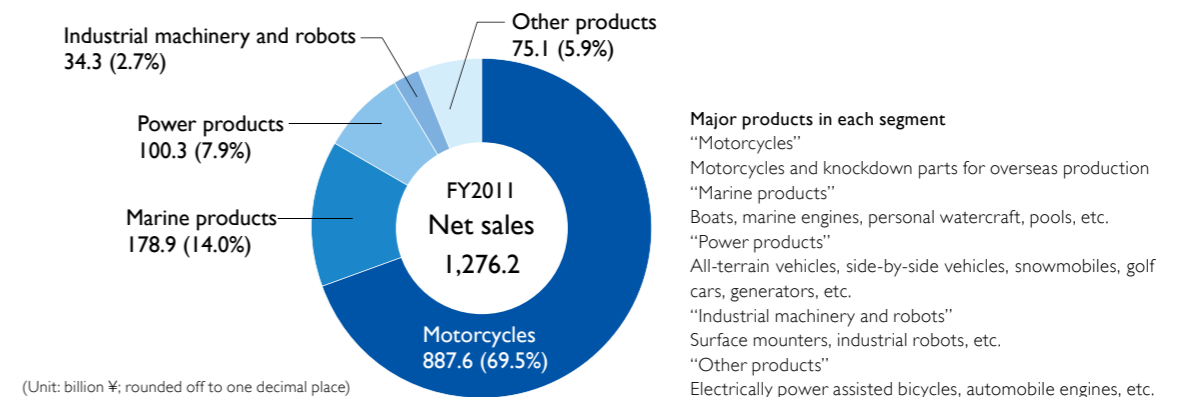

## Sales Breakdown by Region (Consolidated Basis)

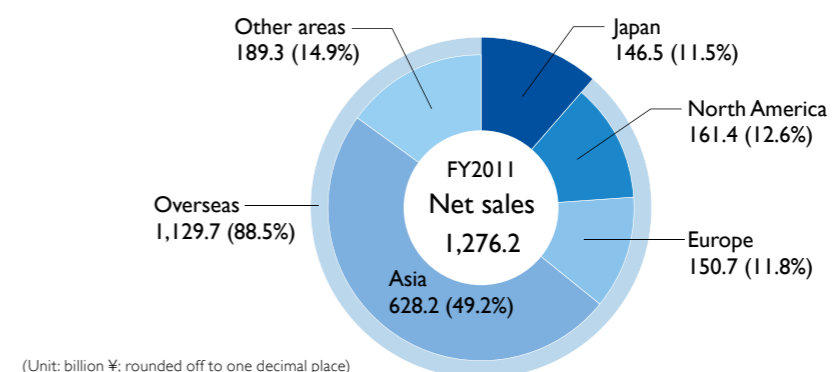

## Organization (As of April 1, 2012)

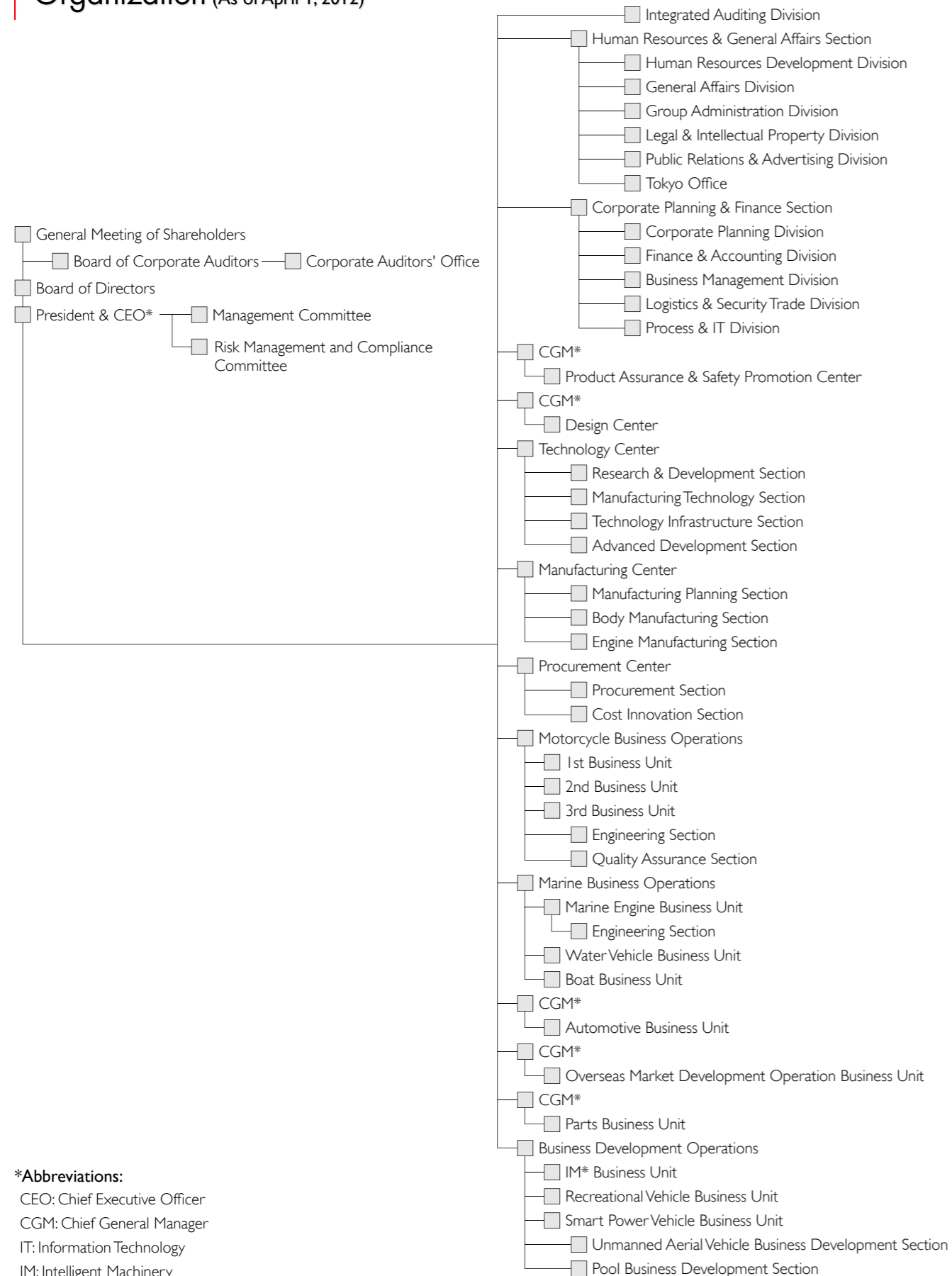

**\*Abbreviations:**

CEO: Chief Executive Officer  
 CGM: Chief General Manager  
 IT: Information Technology  
 IM: Intelligent Machinery

## Board of Directors, Corporate Auditors and Executive Officers (As of April 1, 2012)

### Board of Directors

President and Representative Director

**Hiroyuki Yanagi**



Representative Director

**Takaaki Kimura**



Director

**Hiroyuki Suzuki**

Director

**Kozo Shinozaki**

Director

**Nobuya Hideshima**

Director

**Masahiro Takizawa**

Director

**Yoshiaki Hashimoto**

Director (Outside)

**Yuko Kawamoto**

Director (Outside)

**Masamitsu Sakurai**

Director (Outside)

**Mitsuru Umemura**

### Corporate Auditors

Standing Corporate Auditor

**Yutaka Kume**

Standing Corporate Auditor

**Shigeki Hirasawa**

Corporate Auditor (Outside)

**Norihiko Shimizu**

Corporate Auditor (Outside)

**Tetsuo Kawawa**

### Executive Officers

President and Chief Executive Officer

**Hiroyuki Yanagi**

Chief General Manager of Motorcycle Business Operations

Senior Managing Executive Officer

**Takaaki Kimura**

Chief General Manager of Technology Center, Chief General Manager of Marine Business Operations, Chief General Manager of Design Center, and Chief General Manager of Automotive Business Unit

Senior Executive Officer

**Hiroyuki Suzuki**

Managing Director of India Yamaha Motor Pvt. Ltd.

Senior Executive Officer

**Kozo Shinozaki**

Senior General Manager of Corporate Planning & Finance Section

Senior Executive Officer

**Nobuya Hideshima**

Chief General Manager of Procurement Center and Chief General Manager of Parts Business Unit

Senior Executive Officer

**Masahiro Takizawa**

Chief General Manager of Business Development Operations

Senior Executive Officer

**Yoshiaki Hashimoto**

Senior General Manager of Human Resources & General Affairs Section and Chief General Manager of Product Assurance & Safety Promotion Center

Senior Executive Officer

**Kunihiko Miwa**

Executive General Manager of 2nd Business Unit, Motorcycle Business Operations

Senior Executive Officer

**Katsuaki Watanabe**

Chief General Manager of Manufacturing Center

Senior Executive Officer

**Hajime Yamaji**

President of Yamaha Motor Europe N.V.

Senior Executive Officer

**Ryouichi Sumioka**

Executive General Manager of 3rd Business Unit, Motorcycle Business Operations and Chief General Manager of Overseas Market Development Operation Business Unit

Senior Executive Officer

**Toshizumi Kato**

President of Yamaha Motor Corporation, U.S.A.

Senior Executive Officer

**Yoichiro Kojima**

Executive General Manager of Marine Engine Business Unit, Marine Business Operations

Executive Officer

**Souichi Sasagawa**

President of Yamaha Motor Powered Products Co., Ltd.

Executive Officer

**Hiroshi Yoshii**

Senior General Manager of Manufacturing Technology Section, Technology Center

Executive Officer

**Takahiko Goan**

Executive General Manager of Overseas Market Development Operation Business Unit

Executive Officer

**Masato Adachi**

Executive General Manager of Boat Business Unit, Marine Business Operations

Executive Officer

**Masanori Kobayashi**

Executive General Manager of Product Assurance & Safety Promotion Center, General Manager of Safety Promotion & Traffic System Division, Product Assurance & Safety Promotion Center and General Manager of Communications-Linked BIKES Promotion Division, Technology Center

Executive Officer

**Tsuneji Suzuki**

President of PT. Yamaha Indonesia Motor Manufacturing and President of PT. Yamaha Motor Manufacturing West Java

Executive Officer

**Hiroaki Fujita**

Executive General Manager of IM Business Unit, Business Development Operations, General Manager of Quality Assurance Division, IM Business Unit, Business Development Operations and President and Representative Director of i-PULSE Co., Ltd.

Executive Officer

**Masaru Ono**

Executive General Manager of Parts Business Unit

Executive Officer

**Katsuhito Yamaji**

Senior General Manager of Engine Manufacturing Section, Manufacturing Center and General Manager of Engine SyS Engineering Division, Engine Manufacturing Section, Manufacturing Center

Executive Officer

**Toshinori Kuromoto**

Executive General Manager of 1st Business Unit, Motorcycle Business Operations and Executive General Manager of Design Center

## Group Companies

### Japan

Yamaha Motorcycle Sales Japan Co., Ltd.  
Yamaha Motor Engineering Co., Ltd.  
ELM Design Co., Ltd.  
Sunward International, Inc.  
Sugo Co., Ltd.  
Yamaha Kumamoto Products Co., Ltd.  
Yamaki Manufacturing Co., Ltd.  
Yamaha Amakusa Manufacturing Co., Ltd.  
Maricom Tokai Co., Ltd.  
JOB Co., Ltd.  
Y's Gear Co., Ltd.  
i-PULSE Co., Ltd.  
Yamaha Motor Powered Products Co., Ltd.  
Yamaha Skytech Co., Ltd.  
Nishi Nippon Skytech Co., Ltd.  
Yamaha Motor Electronics Co., Ltd.  
TOYOBESQ CO., LTD.  
Hamakita Industry Co., Ltd.  
Fine Catec Co., Ltd.  
Yamaha Motor Hydraulic System Co., Ltd.  
Melco Co., Ltd.  
Yamaha Motor Assist Co., Ltd.  
Yamaha Motor Support & Service Co., Ltd.  
Yamaha Motor Management Service Co., Ltd.  
Yamaha Motor Solutions Co., Ltd.  
Izumisano Water Front Co., Ltd.  
Marin Wave Otaru Inc.  
Choshi Marina Co., Ltd.  
Marina Akita Co., Ltd.  
Hayama Marina Co., Ltd.  
Yokohama Bay Side Marina Co., Ltd.  
Amagasaki Sports Forest Co., Ltd.  
Ecoole Toyohashi Co., Ltd.  
Sakura Kogyo Co., Ltd.  
A.I.S Corporation  
Yamaha Travel Service Co., Ltd.  
Yamaha Football Club Co., Ltd.  
Mikasa Unyu Co., Ltd.

### ASIA (Abbreviations)

#### China

Yamaha Motor Commercial Trading Shanghai Co., Ltd. (YMCT)  
Shanghai Yamaha Jianshe Motor Marketing Co., Ltd. (YMSM)  
Zhuzhou Yamaha Motor Shock-absorber Co., Ltd. (ZYS)  
Yamaha Motor R&D Shanghai Co., Ltd. (YMRS)  
Yamaha Motor Electronics Suzhou Co., Ltd. (YESZ)  
Yamaha Motor Solutions Co., Ltd. Xiamen (YMSLX)  
Chongqing Jianshe-Yamaha Motor Co., Ltd. (CJYM)  
Zhuzhou Jianshe Yamaha Motor Co., Ltd. (ZJYM)  
Jiangsu Linhai Yamaha Motor Co., Ltd. (LYM)  
Sichuan Huachuan Yamaha Motor Parts Manufacturing Co., Ltd. (SHY)  
Chongqing Pingshan TK Carburetor Co., Ltd. (PTK)  
Yamaha Motor Taizhou O.P.E. Co., Ltd. (YMTO)  
Fuzhou Jiaxin Soqi Power Products Co., Ltd.  
Yantai Melton Mold Co., Ltd.  
Yamaha Motor Powered Products (Jiangsu) Co., Ltd. (YMPJ)

### Indonesia

PT. Yamaha Indonesia Motor Manufacturing (YIMM)  
PT. Yamaha Motor Kencana Indonesia (YMKI)  
PT. Yamaha Motor Manufacturing West Java (YMMWJ)  
PT. Yamaha Motor Parts Manufacturing Indonesia (YPMI)  
PT. Toyo Besq Precision Parts Indonesia (TBI)  
PT. Yamaha Motor Electronics Indonesia (YEID)  
PT. Melco Indonesia  
PT. Yamaha Motor Nuansa Indonesia (YMNl)  
PT. Kyowa Indonesia  
PT. Sakura Java Indonesia

### The Philippines

Yamaha Motor Philippines, Inc. (YMPH)

### Thailand

Thai Yamaha Motor Co., Ltd. (TYM)  
Yamaha Motor Parts Manufacturing (Thailand) Co., Ltd. (YMPT)  
Yamaha Motor Electronics Thailand Co., Ltd. (YETH)  
Yamaha Motor Asian Center Co., Ltd. (YMAC)

### Malaysia

HL Yamaha Motor Research Centre Sdn. Bhd. (HLYR)  
Hong Leong Yamaha Motor Sdn. Bhd. (HLYM)

### Vietnam

Yamaha Motor Vietnam Co., Ltd. (YMVN)  
Yamaha Motor Parts Manufacturing Vietnam Co., Ltd. (YPMV)  
Yamaha Motor Electronics Vietnam Co., Ltd. (YEVN)

### Cambodia

Yamaha Motor Cambodia Co., Ltd. (YMKH)

### India

India Yamaha Motor Pvt. Ltd. (IYM)  
Yamaha Motor Solutions India Pvt. Ltd. (YMSLI)

### Singapore

Yamaha Motor Asia Pte. Ltd. (YMAP)  
Yamaha Motor Distribution Singapore Pte. Ltd. (YDS)

### Taiwan

Yamaha Motor Taiwan Co., Ltd. (YMT)  
Topmost Consulting Co., Ltd. (TCC)  
Yamaha Motor R&D Taiwan Co., Ltd. (YMRT)  
Yamaha Motor Taiwan Trading Co., Ltd. (YMTT)  
Yamaha Motor Electronics Taiwan Co., Ltd. (YETW)

### OCEANIA (Abbreviations)

#### Australia

Yamaha Motor Australia Pty Limited (YMA)  
Ficeda Pty Limited  
Yamaha Motor Finance Australia Pty Limited (YMFA)

#### New Zealand

Yamaha Motor New Zealand Limited (YMNZ)  
Yamaha Motor Finance New Zealand Limited (YMFNZ)

### EUROPE (Abbreviations)

#### The Netherlands

Yamaha Motor Europe N.V. (YMENV)  
Yamaha Motor Netherland B.V. (YMNl)  
Yamaha Motor Middle Europe B.V. (YMME)

#### Germany

Yamaha Motor Deutschland GmbH. (YMG)  
Yamaha Motor IM Europe GmbH. (YIME)

### United Kingdom

Yamaha Motor (UK) Limited (YMUK)

### Italy

Yamaha Motor Italia S.p.A. (YMIT)  
Motori Minarelli S.p.A.  
Yamaha Motor Research & Development Europe S.r.l. (YMRE)  
Yamaha Motor Racing S.r.l. (YMR)

### France

Yamaha Motor France S.A. (YMF)  
MBK Industrie

### Spain

Yamaha Motor Espana S.A. (YMES)  
Yamaha Motor Espana Marketing, S.L. (YMEMS)

### Portugal

Yamaha Motor Portugal S.A. (YMP)

### Sweden

Yamaha Motor Scandinavia AB (YMS)

### Russia

OOO Yamaha Motor CIS (YMCIS)

### Turkey

Yamaha Motor Sanayi ve Ticaret Limited Sirketi (YMTR)

### NORTH AMERICA (Abbreviations)

#### United States

Yamaha Motor Corporation, U.S.A. (YMUS)  
Yamaha Motor Manufacturing Corporation of America (YMMC)  
Century Boat Company, Inc.  
Skeeter Products, Inc.  
Precision Propeller Industries, Inc. (PPI)  
Tennessee Water Craft, Inc. (TWI)  
Yamaha Golf-Car Company (YGC)  
Yamaha Motor Distribution Latin America, Inc. (YDLA)  
Yamaha Motor IM America, Inc. (YIMA)  
**Canada**  
Yamaha Motor Canada Limited (YMCA)

### CENTRAL and

### SOUTH AMERICA (Abbreviations)

#### Brazil

Yamaha Motor do Brasil Ltda. (YMDB)  
Yamaha Motor da Amazonia Ltda. (YMDA)  
Yamaha Motor Componentes da Amazonia Ltda. (YMCDA)  
Yamaha Administradora de Consorcio Ltda. (YAC)  
Banco Yamaha Motor do Brasil S.A. (BYMD)  
Yamaha Motor Corretora de Seguros Ltda. (YMDCS)  
Yamaha Motor Electronics do Brasil Ltda. (YEBR)

#### Argentina

Yamaha Motor Argentina S.A. (YMARG)

#### Peru

Yamaha Motor del Peru S.A. (YMDP)  
Yamaha Motor Selva del Peru S.A. (YMSP)

#### Colombia

Industria Colombiana de Motocicletas Yamaha S.A. (INCOLMOTOS)

#### Mexico

Yamaha Motor de Mexico, S.A. de C.V. (YMMEX)  
Yamaha Motor Consorcio Mexico, S.A. de C.V. (YMCMX)  
Industria Mexicana de Equipo Marino, S.A. de C.V. (IMEMSA)

## History

### 1955

Yamaha Motor Co., Ltd. was founded with Genichi Kawakami as the first President  
Production of our first motorcycle, the 125cc Yamaha motorcycle "YA-1" began  
YA-1 won the 3rd Mount Fuji Ascent Race and captured first three places at the 1st All Japan Autobike Endurance Road Race

### 1958

Took 6th place in first attempt at Catalina Grand Prix in the U.S. (Yamaha's international racing debut)  
Yamaha de Mexico S.A. de C.V. established with investment by Nippon Gakki (presently Yamaha Corporation)

### 1960

Yamaha International Corporation (YIC) founded in U.S. as subsidiary of Nippon Gakki  
First Yamaha outboard motor "P-7" released  
First Yamaha FRP boat "CAT-21" and "RUN-13" released

### 1961

New listing on First Section of Tokyo Stock Exchange  
First appearance in road race World GP  
CAT-21 wins 1st Pacific 1,000 km Motorboat Marathon

### 1963

Pearl Yamaha founded in India  
Won first 250cc class race in road race World GP (Belgium GP)

### 1964

Captures first manufacturer and rider titles in 250cc class of the road race World GP  
Siam Yamaha Co., Ltd. founded in Thailand

### 1965

Tie-up with Toyota Motor Co. to develop and manufacture Toyota 2000GT, model displayed at the Tokyo Motor Show  
First Yamaha FRP fishing boat built

### 1966

Full export operations transferred from Nippon Gakki to Yamaha Motor  
Technical assistance agreement signed with Kong Hsue Sheh to produce motorcycles in Taiwan

### 1967

Liaison office opened in Thailand

### 1968

YMENV founded in the Netherlands  
First Yamaha snowmobile "SL350" exhibited at Chicago Trade Show  
First Yamaha FRP utility boat models "W-16" and "W-18" released

### 1969

First Yamaha multipurpose engine model "MT100" released

### 1970

YMDB founded in Brazil

### 1971

Haraban Motor Co. founded in Indonesia

### 1972

Headquarters moved to present location in Iwata City  
First win in Motocross World GP at Swedish GP (250cc class) and Luxembourg GP (500cc class)

### 1973

YMCA founded in Canada  
Signed joint venture agreement with Brunswick Co. (U.S.)  
Won first manufacturer and rider titles in 250cc class of the Motocross World GP  
First Yamaha portable generator model "ET1250" released  
First Yamaha racing kart model "RC100" released

### 1974

Hisao Koike appointed second YMC president  
Won manufacturer titles in all classes of road race World GP, 125cc, 250cc, 350cc, and 500cc  
YIMM founded in Indonesia as motorcycle parts maker  
Manufacture and sales of FRP pools began

### 1975

OMDO (Overseas Market Development Operations) liaison office opened in Nigeria  
First Yamaha golf car model "YG292" released

### 1976

First Yamaha industrial robot model, an "arc welding robot" released  
First Yamaha marine diesel "MD35" released

### 1977

YMC-related divisions of Yamaha International Corporation separated to found Yamaha Motor Corporation, U.S.A.  
Captures manufacturer and rider titles for the first time in 500cc class of the Motocross World GP

### 1978

First Yamaha land car model "G1-9AD" released  
First Yamaha snow-thrower model "YT665" released

### 1979

Yamaha's first ATV model "YT125" released in the USA  
XT500 wins 1st Paris-Dakar Rally

### 1981

SEMSA founded in Spain

### 1982

Motorcycle production and marketing tie-up with Motobecane (France)

### 1983

Hidetoshi Eguchi appointed third YMC president  
YMDA founded in Brazil  
Technical assistance agreement made for motorcycle production with China North Industries Group  
YMA founded in Australia

Technical assistance agreement made for motorcycle production with Escorts Ltd. in India

### 1984

Signed contract to develop, produce and supply automobile engines to Ford Motor Co. (U.S.)  
Technical assistance contract signed with Italy's Motori Minarelli

### 1986

YMMC founded in U.S.  
YMT founded in Taiwan  
Technical assistance contract for motorcycle technology signed with Italy's Belgarda S.p.A  
First Yamaha personal watercraft (PWC) "MJ-500T" released

### 1987

First Yamaha-made surface mounter "Z1 Series" released  
First Yamaha gas heat pump (GHP) model "YGC401W" released  
Limited production of 20 units of Yamaha's first commercial-use unmanned helicopter "R-50" released

### 1989

Machine mounting the Yamaha "OX88" racing engine competes in F1 for the first time

### 1990

Corporate Mission and long term management vision announced  
YMP founded in Portugal

### 1991

YMF founded in France  
YMMEX founded in Mexico

### 1992

CJYM founded in China  
YMAG founded in Austria  
YMH founded in Hungary

### 1993

NYM founded in China  
Regionally limited release of the electrically power assisted bicycle "PAS"

### 1994

Takehiko Hasegawa appointed as fourth YMC president  
LYM founded in China

### 1995

Wheelchair electric power unit "JW-1" released  
EYML established in India

### 1996

YMARG founded in Argentina

### 1997

YMNl founded in Indonesia

### 1998

YMVN founded in Vietnam  
YMAP founded in Singapore  
YMDP founded in Peru

## History (Continued)

- 2000 Corporate ties with Toyota Motor Corp. strengthened
- 2001 Toru Hasegawa appointed as fifth YMC president
- 2002 Limited regional release of the electric commuter motorcycle "Passol"  
Manufacture of 50cc scooters for the Japanese market shifted to YMT in Taiwan
- 2003 Yamaha Motor Co., Ltd., Moscow Representative Office opened in Russia
- 2004 Won 1st MotoGP rider championship title
- 2005 Takashi Kajikawa appointed as sixth YMC president  
YMCIS founded in Russia  
Life Science Laboratory opened as research and development center for YMC's biotechnology business
- Yamaha captures MotoGP triple crown by winning the rider, team and manufacturer titles
- 2006 Motorcycle manufacturing factory YMMWJ founded in Indonesia  
Mass-production of microalgae as a source for the high-potential health additive Astaxanthin began
- 2007 YMPH founded in the Philippines
- 2008 YMKH founded in Cambodia  
IYM founded in India
- 2009 Tsuneji Togami appointed as seventh YMC president  
Yamaha Marine Co., Ltd. merged into YMC  
YMTR founded in Turkey
- 2010 Hiroyuki Yanagi appointed as eighth YMC president
- 2011 YIME and YIMA group companies founded in Europe and the USA for Intelligent Machinery product sales  
Started increased production of Japanese fishing boats to aid in recovery efforts from the Great East Japan Earthquake and Tsunami  
Iwata South Factory engine assembly line integrated into Iwata Main Factory

## Change in Number of Employees

Fiscal year	2007	2008	2009	2010	2011
Yamaha Motor Co., Ltd. (average age)	9,019 (41.0 years old)	9,396 (38.9 years old)	10,690 (40.7 years old)	10,302 (39.9 years old)	10,159 (40.8 years old)
Consolidated companies	37,831	40,365	39,304	41,882	44,518
Total	46,850	49,761	49,994	52,184	54,677

## Change in Number of Recruited Graduates (Yamaha Motor Co., Ltd.)

Fiscal year	2009	2010	2011	2012	2013 (plan)
Graduates of four-year colleges and graduate schools	249	64	33	109	100
(Office work, marketing)	(43)	(14)	(6)	(35)	(30)
(Engineering, production-related work)	(206)	(50)	(27)	(74)	(70)
Two-year/technical college graduates	26	7	0	1	40
High school graduates	113	0	0	40	
Total	388	71	33	150	140

# FACT BOOK 2012 Product Business Section



### Product Profile

Motorcycles play a familiar and vital role in the lives of people around the world, their applications spanning from pure utility, such as the transportation of goods, to personal enjoyment and sports. The Yamaha Motor group satisfies these needs with its diverse product lineup. Yamaha motorcycles are made to a variety of specifications, each type featuring unique technologies serving its particular use: scooters and mopeds, used primarily for day-to-day mobility, such as commuting and shopping trips; sports models and cruisers, used widely in urban areas and for long-distance touring; “trail models” for off-road excursions; and racing machines, for road racing, motocross, and other competitions.

### Background of the Business

During World War II, Nippon Gakki Co., Ltd. (founded in 1897, presently Yamaha Corporation), the company from which Yamaha Motor was later spun off, was assigned to apply its technologies in musical instrument manufacturing to the production of propellers for military aircraft. After the War ended, the company sought ways to use its manufacturing facilities for peaceful ends. Eventually, it entered the motorcycle business as the motorcycle manufacturing division of Nippon Gakki. The company's first motorcycle model, the YA-1, got off to a successful start, winning in its debut entries at Japan's top two motorcycle races at the time, while also receiving high acclaim for its product quality. To scale up production and market the YA-1, Yamaha Motor Co., Ltd. was established. Some years later, in 1961, Yamaha entered its first World GP race. Since then and to this day, Yamaha has continued to challenge itself on the racing scene, making the art of engineering based on technologies and know-how a hallmark of the Yamaha brand.

### Current Business and Market Conditions

#### Japan

Looking at the market as a whole, scooters with an engine displacement of 50cc and under (Class-I category), which are used primarily for commuting and work-related activities, occupy over half of all unit sales. Motorcycles with an engine capacity of 51cc or larger fall into a number of categories, from scooters to large motorcycles and sports models for personal enjoyment. The Japanese market is also unique in that it has a driver's license restricted to operation of AT (automatic transmission) motorcycles. In recent years, scooters below 125cc (Class-I and Class-II), with their superior utility in urban areas and affordability, have followed a growth trend.

License Type		Allowable engine displacement
Motor-driven cycle license		50cc and under
Standard motorcycle license	Standard motorcycle with small-size engine	Up to 125cc
	Small AT motorcycle only	
	Standard motorcycle	Up to 400cc
	Standard AT motorcycle only	
Large motorcycle license	Large motorcycle	Unlimited
	Large AT motorcycle only	Up to 650cc

#### Europe

As one would expect from the birthplace of motorcycles, motorcycles have a well-established place in European society as part of the culture. The market is characterized by widespread use of motorcycles among riders of all ages as a commuter vehicle and as means for recreation, from touring through the countryside to circuit racing and other sports. Motorsports are also popular there. Over half of the MotoGP racing series, the world's premier motorcycle racing championship, is held in Europe.

#### North America

The North American market is characterized by its predominance of motorcycle enthusiasts. Cruisers, with their low-riding seats and long bodies—perfectly suited for riding on long stretches of straight, open road—are a representative category, but there is also a large segment of users who enjoy riding off-road or on mountainous terrain for sport or recreation. The popularity and extensive variety of motorsports practices by professionals and amateurs alike is another unique quality of the North American market.

#### ASEAN region

The conditions surrounding motorcycles in the ASEAN region, where motorization first took off in the 1980s, are vastly different than those in developed markets. Motorcycles are a primary mode of transportation for commuting to work and school and for daily living in many communities. They also serve an important role as social infrastructure, assisting the flow of goods and services. Easy-to-use “moped-type” motorcycles with a small engine capacity of around 125cc, are traditionally the mainstream choice. However, since the turn of the century there has been a growing segment of users resembling those in developed markets who favor more personalized and luxurious features. Yamaha was quick to introduce automatic-transmission motorcycles to this market, and is now recognized as a leading company.

#### China

With domestic demand for new motorcycles now exceeding 14 million units annually, China has become the world's largest motorcycle market and home to over 100 motorcycle makers. Until recently, Yamaha sales have largely consisted of high value-added models with engine capacities of around 125cc purchased mainly by relatively affluent urban consumers. However, the proliferation of motorcycles in urban areas has spawned new regulations on motorcycle registration, bringing about a shift of the major market to the interior regions. Yamaha is working to expand its product lineup with lower priced models that are more widely affordable.

#### India

In India, the world's second largest market after China and one where domestic demand for new motorcycles now exceeds 13 million units annually, motorcycles with an engine capacity of around 125cc are most common. India is seeing rapid growth of its motorized population and until now, Yamaha had adopted a strategy of building its brand image by rolling out high value-added models, but is now working to expand its product lineup with affordably-priced models.

### Production

Country	Name of Company	
Japan	Yamaha Motor Co., Ltd.	
Europe	France	MBK Industrie
	Spain	Yamaha Motor Espana. S. A.
Asia	Indonesia	PT. Yamaha Indonesia Motor Manufacturing PT. Yamaha Motor Manufacturing West Java
	Thailand	Thai Yamaha Motor Co., Ltd.
	Vietnam	Yamaha Motor Vietnam Co., Ltd.
	Cambodia	Yamaha Motor Cambodia Co., Ltd.
	Philippines	Yamaha Motor Philippines, Inc.
	Malaysia	Hong Leong Yamaha Motor Sdn.Bhd.
Central and South America	Taiwan	Yamaha Motor Taiwan Co., Ltd.
	China	Chongqing Jianshe · Yamaha Motor Co., Ltd. Zhuzhou Jianshe Yamaha Motor Co., Ltd. Jiangsu Linhai Yamaha Motor Co., Ltd.
	India	India Yamaha Motor Pvt. Ltd.
	Brazil	Yamaha Motor da Amazonia Ltda.
	Mexico	Yamaha Motor de Mexico, S.A. de C.V.
	Colombia	Industria Colombiana de Motocicletas Yamaha S.A.
	Argentina	Yamaha Motor Argentina S.A.

# Motorcycles

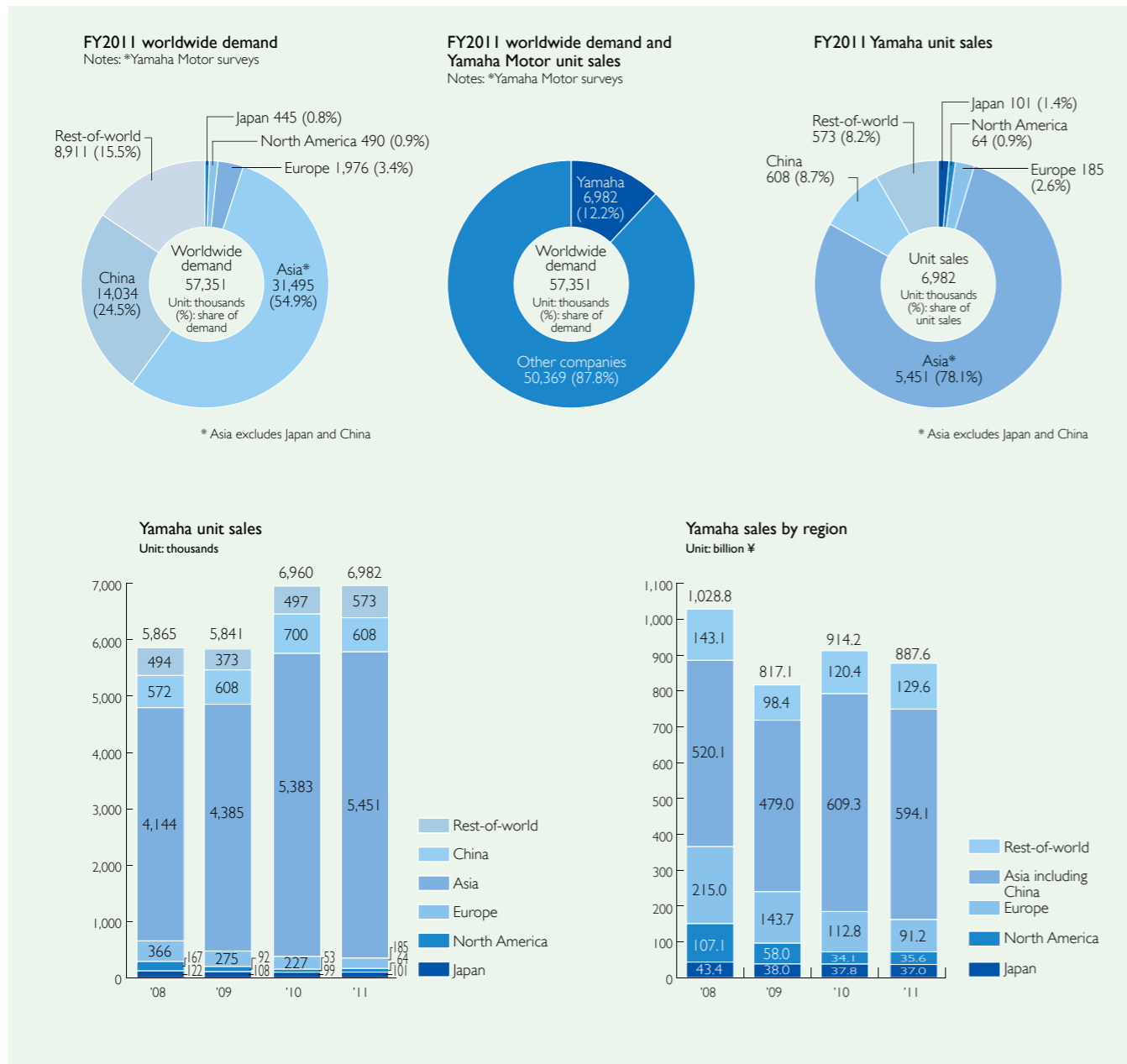

## EC-03 Electric motorcycle



Electric motorcycles, which run solely on battery-supplied electric power, are expected to play an important part in motorized societies of the future, not only because they have a small environmental footprint, but also because they can reduce dependence on fossil fuels. Yamaha Motor has sold its EC-03 electric commuter, designed to maneuver and perform well for shorter distance use in urban areas, in Japan since 2010. For overseas markets, the EC-03 was released in Taiwan and Europe in 2011.

# Boats



EXULT 36 Sport Saloon IPS500

NYTRO

DY-51A-0A

## Product Profile

Boats are used for two major purposes: commercial use and leisure. Commercial boats can be categorized roughly into Japanese-style utility boats and fishing boats, both of which are an indispensable part of the everyday lives of fishermen. Recreational boats include powerboats, used for activities from sport fishing to cruising and waterskiing, and sailboats.

## Background of the Business

Since the latter part of the 1950s, Yamaha started joint research and development of FRP (Fiber Reinforced Plastics) — a promising new material at the time—with Nippon Gakki Co., Ltd. (presently Yamaha Corporation), and in 1960 began producing and marketing FRP boats. In 1965, the Company also started production of sailboats and fishing boats.

Yamaha Motor has continuously developed and designed its products using performance simulation and 3D CAD systems, and introduced new manufacturing technologies to reduce the environmental impacts of production.

## Current Business and Market Conditions

In Japan, Yamaha Motor is a full-spectrum marine manufacturer, offering a full lineup of products in all categories, from fishing and utility boats—the hulls of which must be designed to fit the requirements of each region's fishing methods—to large recreational sport boats and sailing cruisers.

## Production

	Name of Company	Location
Fishing boats, utility boats	Yamaki Manufacturing Co., Ltd. *1	Yakumo, Hokkaido, Japan
Small boats, utility boats	Yamaha Amakusa Manufacturing Co., Ltd. *1	Kamiamakusa, Kumamoto, Japan
Medium and large boats	YM Shido Co., Ltd. *2	Sanuki, Kagawa, Japan

Notes: \*1 Group company \*2 Contract manufacturer

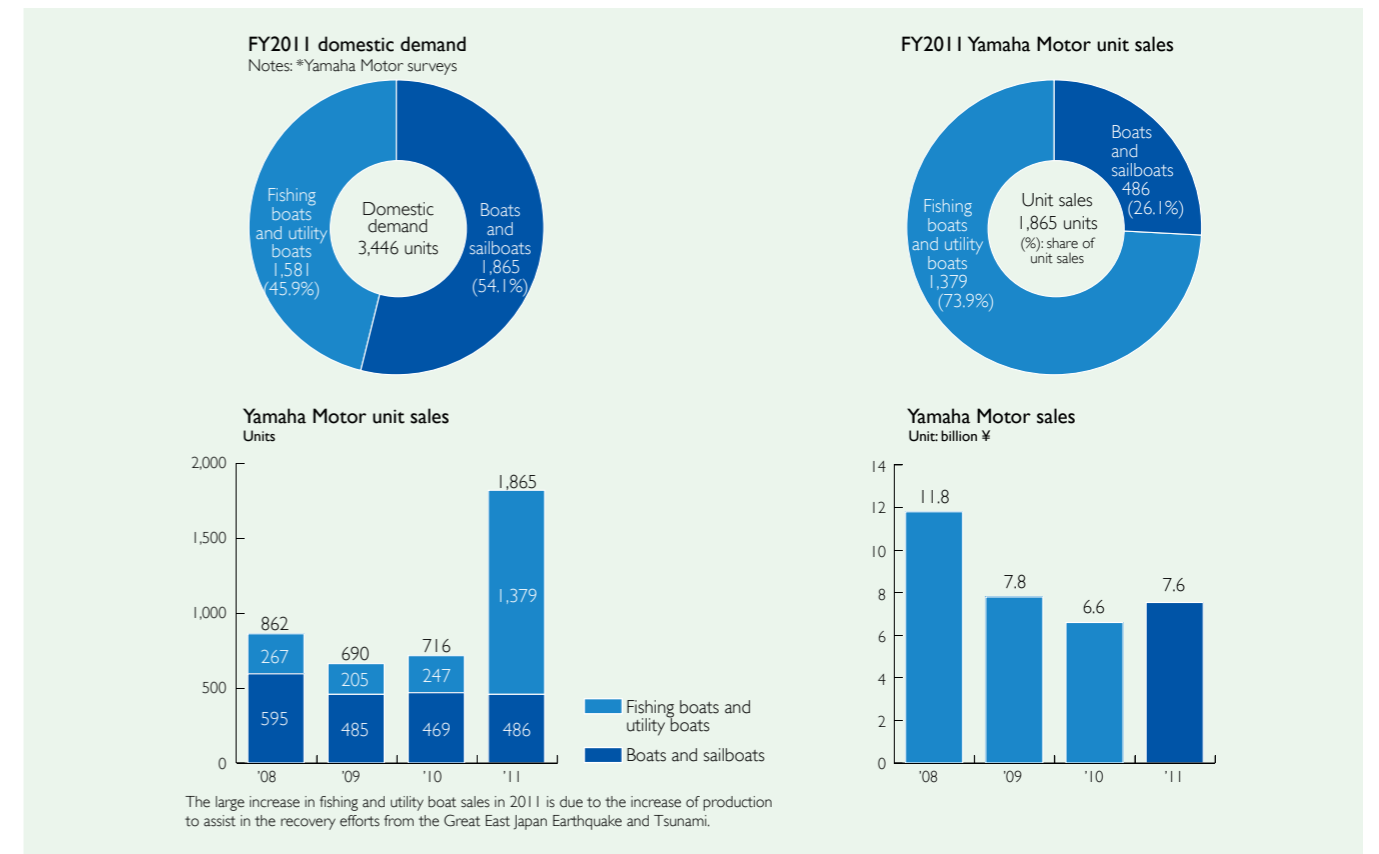





### Product Profile

Marine engines used to propel boats can be categorized into three types: outboard motors, stern drives (inboard-outboard motors), and inboard motors. Outboard motors, which are suited for small- to medium-size boats, are used by people engaged in a variety of activities all around the world. In developed regions like Europe and North America, they are primarily used for leisure, while in emerging countries they are predominantly used for fishing and transport/transportation. Marine diesel engines (inboard) and stern drive engines (inboard-outboard) are also useful as a means of propulsion for recreational boats and for small fishing boats used for inshore fishing.

### Outboard motors

For small- to medium-size boats. The entire unit—engine to propeller—is mounted on the outside of the boat.



### Stern drives (Inboard-outboard motor)

For small- to medium-size boats. The engine is mounted inside the hull at the stern, with the drive unit and propeller mounted outside the hull.

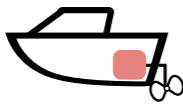

### Inboard motors

For large boats. The engine is situated at the center of the hull, and rotates the propeller via a driveshaft.

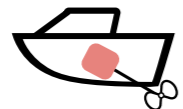

### Background of the Business

Applying its small engine technology developed for motorcycles, Yamaha Motor released its first marine engine, the small outboard engine P-7, in 1960. In the half century that followed, the Company has expanded its marine engine lineup to suit manifold uses and conditions in the various locations they are used, focusing especially on outboard motors, including models with increasingly large horsepower and models that have better fuel efficiency and are designed to withstand more extreme environments. Cumulative production of Yamaha outboard motors topped 9 million units in March 2010.

### Current Business and Market Conditions

More than 90% of Yamaha outboard motors are exported to markets worldwide, where they are currently being sold in over 180 countries and regions. Their applications cover everything from fishing to leisure, and include the more simply constructed 2-stroke models suitable for operating environments in emerging countries, 4-stroke models which are in high demand in developed countries and also offer exceptional environmental performance, as well as electric models used for freshwater and inshore fishing and other activities. Yamaha Motor also offers a complete lineup of inboard and stern drive motors for everything from commercial applications to recreational boating.

### Environmental compliance

Yamaha Motor offers a full line of products that comply with voluntary restrictions set by the Japan Boating Industry Association, as well as standards set by 2010 EPA (United States Environmental Protection Agency) regulations on exhaust emissions and 2008 CARB (California Air Resources Board) regulations.

### Production

	Name of Company (Factory)	Location
Medium- and large-size 4-stroke outboard motors and large-size 2-stroke outboard motors	Yamaha Motor Co., Ltd. (Fukuroi South Factory / Iwata South Factory)	Fukuroi/Iwata, Shizuoka, Japan
Small-size 4-stroke outboard motors and small- and medium-size 2-stroke outboard motors	Yamaha Kumamoto Products Co., Ltd. *	Yatsushiro, Kumamoto, Japan
Small-size 4-stroke outboard motors	MBK Industrie *	Saint-Quentin, France

Notes: \* Group company

FY2011 worldwide demand for outboard motors  
Notes: \*Yamaha Motor surveys

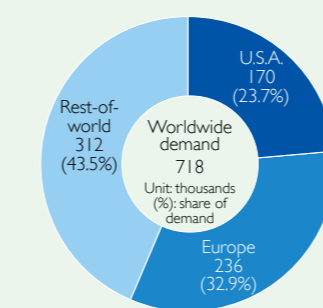

FY2011 worldwide demand and Yamaha Motor unit sales of outboard motors  
Notes: \*Yamaha Motor surveys

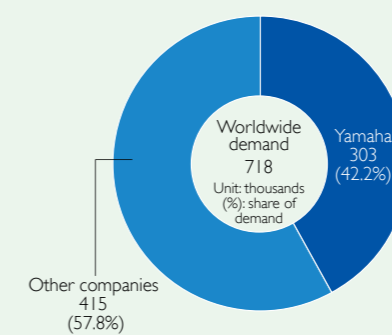

FY2011 Yamaha Motor unit sales of outboard motors

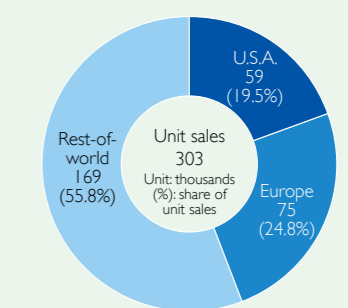

Yamaha Motor unit sales of outboard motors  
Unit: thousands

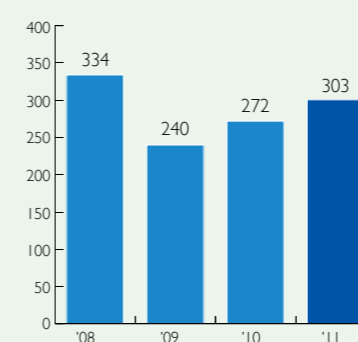

Yamaha Motor sales from marine engines  
Unit: billion ¥

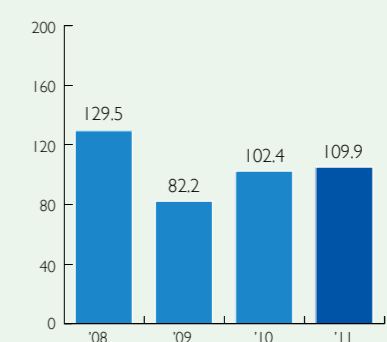

## Personal Watercraft



MJ-FX Cruiser SHO



ARI90

### Product Profile

Personal watercraft (or PWC) come in two varieties: one that requires the rider to stand (one-person capacity), and another that is ridden from a seated position (up to three people). PWC mount a small engine, but rather than using a propeller for propulsion they draw in water from the intake section at the bottom of the hull and shoot it out from the back with a jet-propulsion mechanism. The Yamaha ARI90 High Output is a sport boat that uses the same kind of propulsion system.

### Background of the Business

Applying small engine technologies and FRP molding technologies developed for motorcycles, outboard motors and boats, Yamaha Motor released its first PWC product, the MJ-500T, in 1986. The product's marketing concept, "A water vessel anyone can ride, with assurance and convenience," was welcomed by markets and effectively expanded the enjoyment of marine recreation beyond existing mainstream activities like cruising and fishing.

### Current Business and Market Conditions

Yamaha PWC feature a highly stable and streamlined body built on technologies Yamaha Motor developed for boats, and a compact, lightweight, yet powerful engine utilizing the Company's motorcycle and marine engine technologies. Most Yamaha PWC employ 4-stroke engines. These models meet environmental regulations in the U.S. and Japan, the largest markets, which include U.S. EPA (Environmental Protection Agency) regulations and Japan Boating Industry Association voluntary regulations.

### Production

	Name of Company (Factory)	Location
Engines	Yamaha Motor Co., Ltd. (Kuramatsu Factory)	Hamamatsu, Shizuoka, Japan
Hulls	Yamaha Motor Manufacturing Corporation of America *	Georgia, U.S.A.
	Tennessee Water Craft, Inc. *	Tennessee, U.S.A.

Notes: \* Group company

FY2011 worldwide demand for PWC  
Notes: \*Yamaha Motor surveys

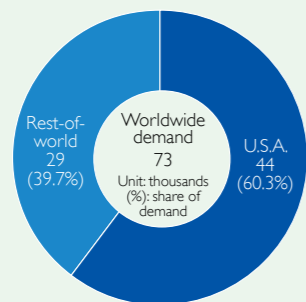

FY2011 Yamaha Motor unit sales of PWC

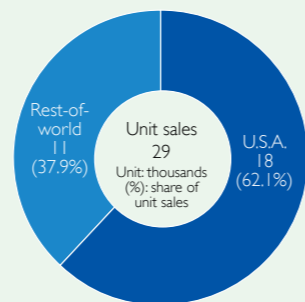

Yamaha Motor unit sales of PWC  
Unit: thousands

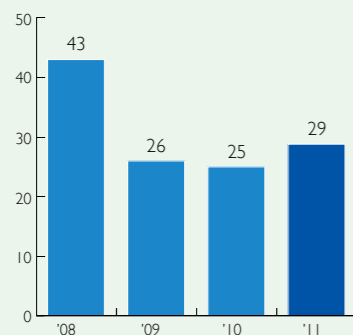

Yamaha Motor sales from PWC  
Unit: billion ¥

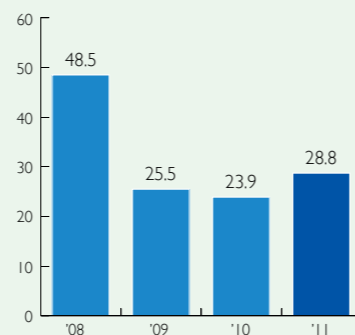

## Swimming Pools



School pools



Amusement park pools



Unit pools



Eyewashing units

### Product Profile

In Japan, school swimming pools, children's pools, leisure pools, pools for health and rehabilitative use and pools for competition use form the major demand for this segment. By material, pools can be categorized into FRP (Fiber Reinforced Plastics) pools, metal pools and concrete pools.

### [Reference] The Advantages of FRP Pools

FRP is a durable, lightweight material that moulds easily and shortens construction time by enabling on-site assembly of factory-made units.

### Background of the Business

Utilizing FRP technologies cultivated in boat development and manufacturing, Yamaha Motor succeeded in commercializing Japan's first 100% FRP pool in 1974. Since then, the Company has installed over 30,000 pools in Japan. In 2007, Yamaha Motor reached its 5,000th-unit milestone for total school pools installed, the highest of any pool manufacturer in Japan.

### Current Business and Market Conditions

Currently, more and more kindergartens and daycare centers are installing pool facilities while public and school pool facilities are starting to show age. Pools are also being used for health improvement, safer water exercise and rehabilitation for older and physically challenged members of the community and by hospitals and health institutions. Yamaha Motor is actively involved in expanding its lineup of pools to support lifestyle changes and a wide range of uses, finding environmentally friendly ways to recycle and reuse swimming pools and the development and marketing of pool-related equipment and systems. The Company also offers maintenance and management services for public pools.

### Production

Name of Company (Site)	Location
Yamaha Motor Co., Ltd. (Arai Site)	Kosai, Shizuoka, Japan

FY2011 domestic school pool demand by material  
Notes: \*Yamaha Motor surveys

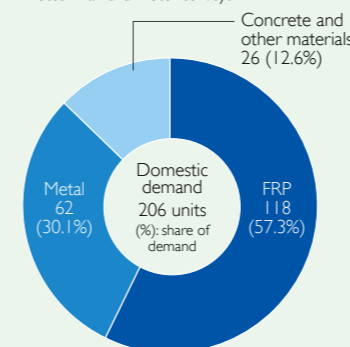

FY2011 Yamaha Motor unit sales of domestic FRP pools

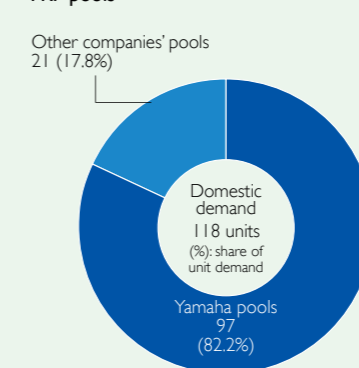

Yamaha Motor pool business sales  
Unit: billion ¥

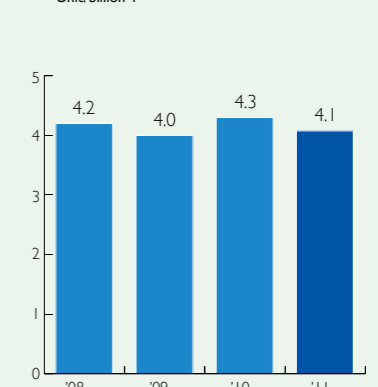

## All-Terrain Vehicles & Side-by-Side Vehicles



YFM700R



Grizzly 700



Rhino 700 FI Auto

### Product Profile

All-Terrain Vehicles (ATVs), also called four-wheel buggies, can handle all sorts of terrain, including unpaved roads, sand and rugged ground. Especially popular in the vast, open landscape of North America, ATVs are used for a broad range of applications, including hunting and other forms of outdoor leisure, off-road and desert sports, and as a utility vehicle for performing agricultural chores and other jobs. Broken down by application, about 60% of ATVs are used for leisure, 20% for sports and 20% for utility work, which includes transporting cargo, guiding livestock, planting seeds and spreading fertilizer.

Side-by-side vehicles (SSVs) are a type of ATV with passenger and driver seats placed side-by-side and a steering wheel for driving. They are used primarily for leisure and sport activities.

### Background of the Business

ATVs were developed using technologies created in the process of developing and manufacturing off-road motorcycles. Sales of Yamaha ATVs began in the U.S. with Yamaha Motor's first product, the YTI25, in 1979, and in Japan in 1986.

### Current Business and Market Conditions

The United States accounts for more than 50% of worldwide demand due to its having large stretches of natural terrain, unpaved roads, and open ranches and farms where ATVs perform well. Yamaha Motor meets diverse needs with its wide range of products including utility, sports and youth-oriented models. First released in 2003, Yamaha Motor's SSVs find the greatest demand in the U.S. market.

### Production

Name of Company	Location
Yamaha Motor Powered Products Co., Ltd. *	Kakegawa, Shizuoka, Japan
Yamaha Motor Manufacturing Corporation of America *	Georgia, U.S.A.

Notes: \* Group company

## Snowmobiles



Apex SE



RSventure GT



FXNyro R-TX

### Product Profile

The snowmobile uses two skis at the front for changing directions and track belts at the rear for engine-driven propulsion. It has developed into a mode of transportation for people in snowy areas, and also as a source of motor sports and leisure enjoyment. Applications can be broken down roughly into leisure and utility. Additionally, in Japan snowmobiles are also used in winter for power line maintenance, for spreading snow-melting agents on cultivated areas, for fish farming in frozen lakes etc.

### Background of the Business

Applying the engine technologies it had developed for motorcycles, Yamaha Motor released its first snowmobile model, the SL350, in 1968 and its first model for recreational use in 1970. Since then the Company has worked to expand its lineup, catering to a variety of needs as the only snowmobile manufacturer (of completely built up units) in Japan.

### Current Business and Market Conditions

While the U.S., Canada, Scandinavia (Sweden, Norway, Finland) and Russia constitute the largest markets, Yamaha snowmobiles are sold in over 30 countries worldwide, including Japan, Austria, Switzerland, Ukraine, Kazakhstan, Mongolia, China, South Korea and New Zealand. In recent years, demand for environmental performance has grown even for snowmobiles. Yamaha Motor has complied with this movement by actively developing models with 4-stroke engines.

### Production

Name of Company (Factory)	Location
Yamaha Motor Co., Ltd. (Iwata Main Factory)	Iwata, Shizuoka, Japan

FY2011 worldwide demand for ATVs  
Notes: \*Yamaha Motor surveys

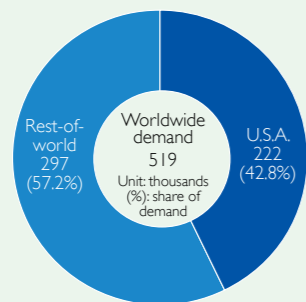

FY2011 Yamaha Motor unit sales of ATVs

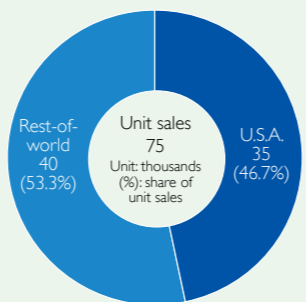

Yamaha Motor units sales of ATVs & SSVs  
Unit: thousands

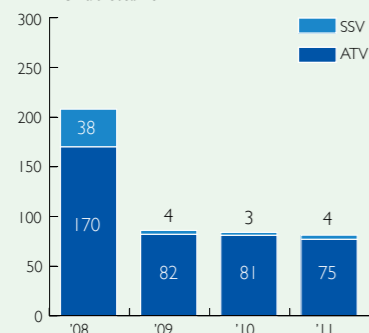

Yamaha Motor sales from ATVs & SSVs  
Unit: billion ¥

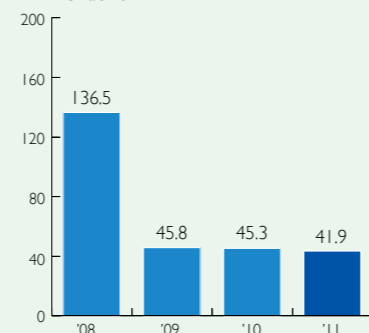

FY2011 worldwide demand for snowmobiles  
Notes: \*Yamaha Motor surveys

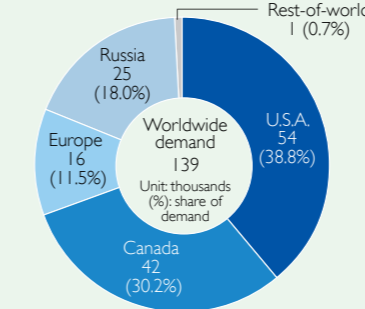

FY2011 Yamaha Motor unit sales

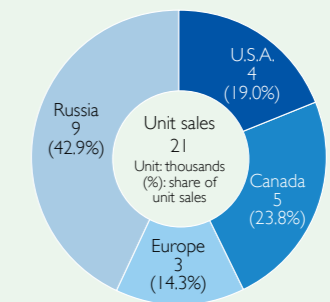

Yamaha Motor unit sales  
Unit: thousands

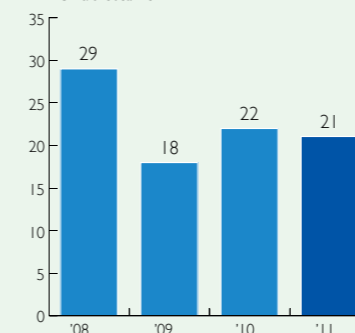

Yamaha Motor sales  
Unit: billion ¥

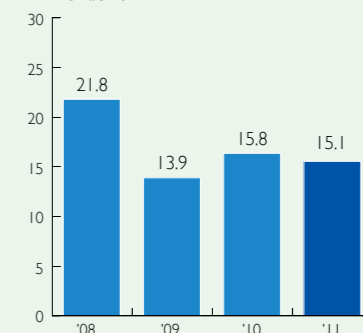

## Golf Cars



YDR



TurfLiner G30A

### Product Profile

Golf cars have become popular on golf courses today because they save labor, let golfers transport their own clubs, lighten work for caddies, and encourage smoother, more enjoyable rounds. Various specifications are available based on market and consumer (golf clubs and resorts) needs. Options include passenger capacity (1, 2, or 5 passengers), the power unit (gasoline engine or electric motor) and the operating system (electromagnetic guidance or manual).

### Background of the Business

In 1972, Yamaha Motor began developing a land car for use at a resort owned and operated by Nippon Gakki (presently Yamaha Corporation), later segueing into the development of golf cars, which the Company released for the first time in 1975 with its YG292 model. With business expanding in subsequent years, Yamaha Motor constructed a new production plant in the U.S. in 1988 to supplement its Japanese plant. All told, the Company has made over 1 million golf cars.

### Current Business and Market Conditions

In Japan, demand is highest for five-passenger models, which also carry caddies, and in the U.S, where caddies are often not used, demand is highest for two-passenger models. Working to create an easier, more comfortable round for golfers, Yamaha Motor introduced in 1996 a model that can be remote control operated, with an electromagnetic guidance system that uses mounted sensors to automatically trace electric cables buried underground. In 2000, the Company introduced a more environmentally friendly model equipped with a much quieter electric motor.

### Production

Name of Company	Location
Yamaha Motor Powered Products Co., Ltd. *	Kakegawa, Shizuoka, Japan
Yamaha Motor Manufacturing Corporation of America *	Georgia, U.S.A.

Notes: \* Group company

FY2011 worldwide demand for golf cars  
Notes: \*Yamaha Motor surveys

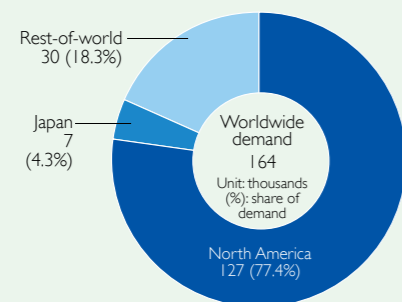

FY2011 Yamaha Motor unit sales of golf cars

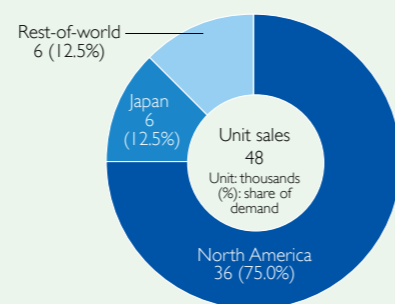

Yamaha Motor unit sales of golf cars

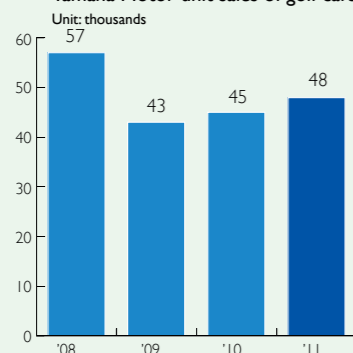

Yamaha Motor golf car business sales

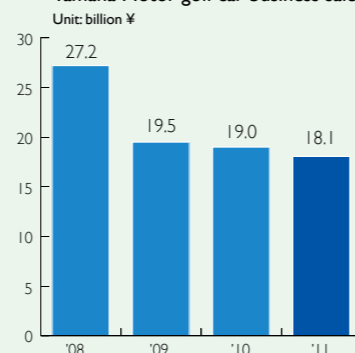

## Generators



EF1600iS



EF5500iSDE

### Product Profile

Yamaha generators use a small gasoline-powered engine to generate electricity. Models offered include everything from light and compact generators that can be carried around with one hand, to utility generators used as a power source for tools and lighting equipment at construction sites and in other settings. Yamaha Motor also provides inverter-type generators, which can be used as a power source for computers and other precision electronic equipment. These generators are also indispensable as an emergency power source during power outages and in disaster areas.

### Background of the Business

Building on its small engine technologies, Yamaha Motor released its first generator model, the ET1250, in 1973.

### Current Business and Market Conditions

As needs for generators expand beyond business applications, these products now need to be quieter, easier to operate, and applicable to a broader range of operating environments in addition to of-

fering sufficient durability, reliability, and quality, sustained power. Meanwhile, Yamaha Motor is actively developing new 4-stroke and inverter-type models that meet voluntary regulations set by the Japan Land Engine Manufacturers Association and other strict emissions standards adopted around the world.

### Production

Name of Company	Location
Yamaha Motor Powered Products Co., Ltd. *	Kakegawa, Shizuoka, Japan
Fuzhou Jiaxin Soqi Power Products Co., Ltd. *	Fujian, China
Yamaha Motor Powered Products (Jiangsu) Co., Ltd. *	Jiangsu, China

Notes: \* Group company

## Snow Throwers



YU240



YS-1070T

### Product Profile

Snow throwers make living out the winter easier in snow-bound regions such as Hokkaido, Tohoku, Kita-Kanto, Koushinetsu, Hokuriku, and Sanin in Japan. Yamaha Motor offers a broad range of snow thrower models, from compact units handy for clearing porches and walkways at home to large models suited for commercial use.

### Background of the Business

Utilizing its small engine technologies, Yamaha Motor released its first snow thrower model, the YT665, in 1978.

### Current Business and Market Conditions

Yamaha Motor offers a total of 12 snow thrower models, ranging from a compact 2-horsepower home-use unit to a 13-horsepower commercial-use model. Yamaha snow throwers have been recognized for the materials and construction of their various components, their exceptional cold-weather performance, and unique designs that enable quiet operation—advantages made possible with the Company's snowmobile manufacturing expertise.

### Production

Name of Company	Location
Yamaha Motor Powered Products Co., Ltd. *	Kakegawa, Shizuoka, Japan
Fuzhou Jiaxin Soqi Power Products Co., Ltd. *	Fujian, China

Notes: \* Group company

# Electrically Power Assisted Bicycles



PAS Brace-L



PAS CITY-X



PAS Natura L Deluxe



PAS Ami



PAS LITTLEMORE

## Product Profile

Electrically power assisted bicycles are bicycles equipped with a motor and battery that supply power to assist the rider's pedaling. The Yamaha PAS released in 1993 was the first electrically power assisted bicycle in the world. Yamaha PAS bicycles are not only ease-to-use and convenient, they also effectively eliminate the major drawbacks of conventional bicycles (difficulty in riding uphill, against the wind, or when carrying cargo), making them accessible to virtually everyone. Electrically power assisted bicycles are gaining popularity as a new category of commuter vehicles for people of all ages, facilitating various forms of personal transportation—commuting to and from work or school, taking children to kindergarten and back home, and even for making work rounds in the city.

## Background of the Business

In the 1980s, a new consciousness emerged around global environmental problems such as energy conservation and societal challenges such as Japan's aging population and low birthrate. This spurred Yamaha Motor's efforts to develop a new vehicle that transcended the boundaries set by conventional product categories. Deploying a new development concept that focused on providing a "people-friendly, environmentally friendly vehicle that puts human sensibilities first," Yamaha Motor launched in 1993 the world's first electrically power assisted bicycles. Since then, the Company has pioneered the market through technological improvements and by driving demand; by the end of 2008, Yamaha Motor had sold over one million units. In addition, control technologies developed in this field are being applied to other Yamaha products in the electric wheelchair and electric motorcycle segments.

## Current Business and Market Conditions

Since releasing the first Yamaha PAS in 1993, Yamaha Motor has made various improvements and additions to its lineup without altering its original product concept. At the same time, needs for electrically power assisted bicycles have diversified and the market has expanded together with a growing awareness of health and environmental issues, changes in transportation, and spiraling gasoline prices. Legal standards applied to the use of electrically power assisted bicycles have also changed, including the revision of a law regulating the assist rate of electrically power assisted bicycles in 2008 and the establishment of a safety standard for bicycles with two infant seats in 2009.

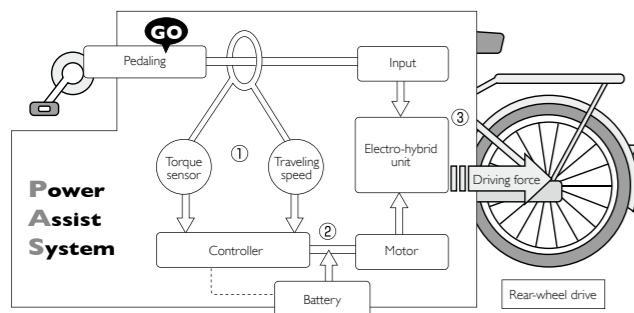

## Assistance Ratio for Electrically Power Assisted Bicycles (Image)

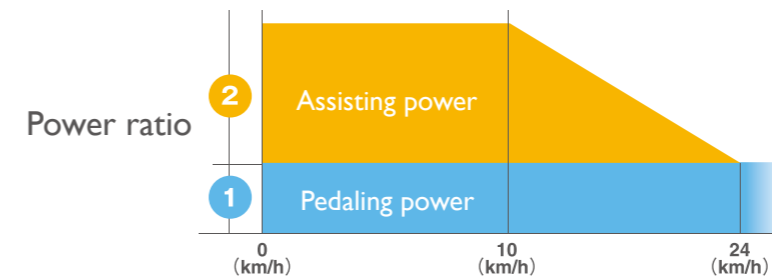

Up to 10km/h, electric power assists pedaling at a maximum ratio of 1:2\*  
 Above 10km/h, electric power assist is moderated to keep the bicycle from going too fast  
 Above 24km/h, electric power assist is cut off  
 \*The maximum ratio set by legal standards

## Production

	Name of Company	Location
Power assist units	Yamaha Motor Electronics Co., Ltd. *1	Morimachi, Shizuoka, Japan
Vehicle body	Bridgestone Cycle Co., Ltd. *2	Ageo, Saitama, Japan

Notes: \*1 Group company \*2 Contract manufacturer

## FY2011 domestic demand of CBU models\*

Notes: Yamaha Motor surveys

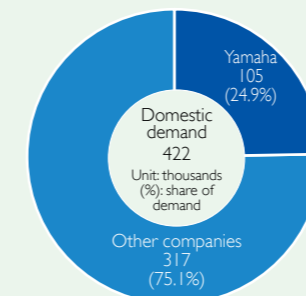

## FY2011 Yamaha Motor unit sales of CBU models\*

Unit: thousands

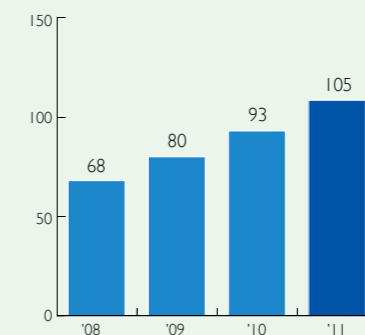

## FY2011 Yamaha Motor sales of CBU models\* and OEM

Unit: billion ¥

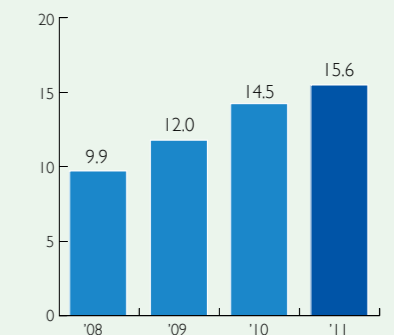

Notes: \* CBU: completely built up

## Electric Wheelchairs



Wheelchair electric power units



Lightweight electric wheelchairs

### Product Profile

Wheelchairs help disabled and elderly people gain mobility. There are basically two types of wheelchairs: manual and electrically powered models. Yamaha Motor presently markets electric power units for converting manual wheelchairs into electric wheelchairs, electric power assist units for manual wheelchairs for easier mobility and lightweight electric wheelchairs (completely assembled) with electric power units built in.

#### - Wheelchair Electric Power Units -

These units are used to convert hand-operated wheelchairs into electric wheelchairs. Each unit consists of a joystick for operation, two wheels with a built-in motor and clutch system, and a light, compact battery. Operating a clutch lever allows shifting between manual and electric modes.



When mounted (image)

#### - Wheelchair Electric Power Units (Assist type) -

These units are used to convert hand-operated wheelchairs into electric power assisted wheelchairs. This system features an electric motor that supplies power assistance when the wheelchair user turns the wheel handrims—the same technology employed in electrically power assisted bicycles (PAS). Each unit consists of two wheels with a motor and clutch system built into the hub, and a light, compact battery.

#### - Lightweight Electric Wheelchairs -

These wheelchairs come completely constructed with an electric power unit built in. Yamaha's wheelchairs feature a slim, lightweight, and collapsible design, and can be shifted between electric and manual modes.

### Background of the Business

Hoping to advance public welfare and offer solutions to the challenges faced by Japan's aging population, Yamaha Motor started work in the early 1990s applying its original electronic control and drive technologies to the development of electric power units for manual wheelchairs, and in 1995 began limited-area marketing of its first product (nationwide marketing in 1996). Soon after, in 1996, the Company utilized its proprietary technologies for electrically power assisted bicycles to release its first electric power assist unit for helping wheelchair users go places with less effort, and in 2001 it released its first electric wheelchair for electrically assisting caregivers when pushing wheelchairs. As these examples suggest, Yamaha Motor has consistently expanded and improved its product lineup to provide wheelchair users with enhanced comfort and convenience and to lighten the load borne by caregivers.

### Current Business and Market Conditions

In Japan, most electric wheelchairs are used by disabled people as certified prosthetic appliances. Combined with the increasing number of elderly people who use rental wheelchairs under the long-term care insurance system, the number of electric wheelchair users is slowly growing. Outside Japan, Yamaha Motor supplies products as an OEM to value-added resellers in the U.S., Europe and other regions.

### Production

Name of Company	Location
Yamaha Motor Co., Ltd. (Hamamatsu IM Site)	Hamamatsu, Shizuoka, Japan

## Industrial Machinery and Robots



YG300 surface mounter



Single-axis robots



Cartesian robots



SCARA robots

### Product Profile

Surface mounters are industrial robots that are designed to mount electronic components onto printed circuit boards used in the electrical components for mobile phones, automobiles, and other electronic products. These devices can be classified into high-speed and general-purpose machines. Yamaha Motor's core products in this field are general-purpose, medium-size surface mounters. Industrial robots are used for a variety of production-related tasks and can be divided into three categories: single-axis robots used for parts transport and assembly, cartesian robots designed to perform advanced tasks, and horizontal multi-joint (SCARA) robots, which can perform bolt/screw tightening and other complex tasks.

### Background of the Business

Yamaha Motor began research and development of industrial robots in 1974 to streamline the production of its motorcycles and improve manufacturing precision. In 1976, the Company introduced SCARA robots in-house to assemble parts on its motorcycle production lines, and in 1981 entered the industrial robot business. In 1987, the Company began marketing surface mounters, the cumulative sales of which had reached 20,000 units by 2007.

### Current Business and Market Conditions

Surface mounters, Yamaha Motor's core product in this business segment, are high-speed modular units that boast superior mounting speed in both standalone applications and multiple-unit configurations. Yamaha Motor commands the largest market share for general-purpose surface mounters. In 2006, the Company moved into the high-speed mounter segment when it developed the YG300 surface mounter, which has achieved the industry's highest throughput, at 105 thousand chips per hour. Meanwhile, the Company has also evolved into a comprehensive manufacturer of chip mounting equipment, expanding its business by adding screen printers, testers and other products.

### Production

Name of Company (Site)	Location
Yamaha Motor Co., Ltd. (Hamamatsu IM*1 Site)	Hamamatsu, Shizuoka, Japan
i-PULSE Co., Ltd. *2	Hamamatsu, Shizuoka, Japan

Notes: \*1 IM: Intelligent Machinery \*2 Group company

Yamaha Motor sales of industrial machinery and robots

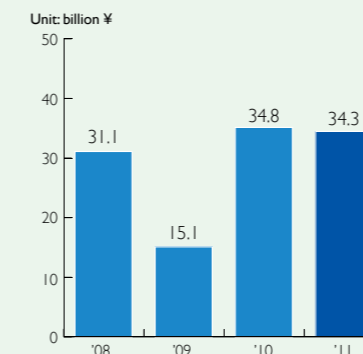

## Automobile Engines



Automobile engines



Performance dampers

### Product Profile

Yamaha Motor's automobile engines feature high revolution speeds and high power, reflecting engine technologies the Company has acquired over the years through manufacturing motorcycles. The engine mounted on the Lexus LFA sports car (developed jointly with Toyota Motor Corporation) is the most recent example of these products. Yamaha Motor also develops and manufactures suspension systems and other products using related technologies. The Company's Performance Damper, which enhances car performance by creating a smoother, more comfortable ride, is used in the Lexus CT200h, a luxury hybrid car. These and other Yamaha Motor technologies enjoy a high reputation in the industry.

### Background of the Business

Ever since its founding, Yamaha Motor has amassed various technologies through its motorcycle development activities. Meanwhile, the Company has also conducted research and development of engine-related technologies for automobiles. In 1967, the Company entered a development and manufacturing venture for the Toyota 2000GT sports car together with Toyota Motor Corporation (then known as Toyota Motor Co., Ltd.). This had the effect of spurring further collaborative work with automobile makers; in 1989, Yamaha Motor also started participating in the Formula One, the world's premier car racing series. In these ways, the Company has been a perpetual agent of innovation in automobile engine technologies.

### Production

	Name of Company (Factory)	Location
Assembly	Yamaha Motor Co., Ltd. (Iwata Main Factory)	Iwata, Shizuoka, Japan
Processing	Yamaha Motor Co., Ltd. (Fukuroi Factory)	Fukuroi, Shizuoka, Japan

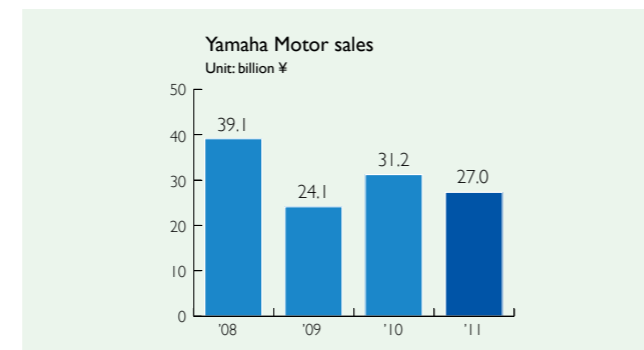

## Industrial-use Unmanned Helicopters



RMAX Type II G

### Product Profile

For its industrial-use unmanned helicopters, Yamaha Motor has developed support systems that incorporate a GPS-based speed control function for more stable operation, as well as altitude control systems that enable unmatched ease of operation and flying stability. These achievements bring to bear the various control technologies that are one of the core competencies of Yamaha Motor.

### - Agricultural Applications -

Major users include municipalities, National Federation of Agricultural Cooperative Associations, agricultural cooperatives, crop-dusting organizations and individual farmers. Their primary application is spraying agricultural chemicals. Yamaha industrial-use unmanned helicopters used in agriculture make jobs more efficient and thus help to improve productivity and reduce labor.

### - Observational and Surveying Applications -

Yamaha Motor provides municipalities, university research institutions, and other organizations with services for using industrial-use unmanned helicopters to conduct observations, surveys and other related applications.

### Background of the Business

In the early 1980s, Yamaha Motor was commissioned by a government organization to develop an industrial-use unmanned helicopter that could easily perform agricultural crop dusting operations. In 1987, the Company commercialized the world's first industrial-use unmanned helicopter for industrial use—the R-50—and commenced full-scale marketing of the product in 1989.

Since then, Yamaha Motor has contributed to the advancement of modern agriculture as the leading manufacturer of industrial-use unmanned helicopters in Japan.

### Production

	Name of Company	Location
Engines, transmissions, etc.	Yamaha Motor Powered Products Co., Ltd. *	Kakegawa, Shizuoka, Japan
Control, electric related	Yamaha Motor Electronics Co., Ltd. *	Morimachi, Shizuoka, Japan

Notes: \* Group company

## Other Products

### Parts and Accessories



Yamaha Motor sells replacement parts for its motorcycles, marine and other products, as well as accessories such as helmets and apparel.

### Pleasure-use Boat Mooring Equipment



Yamaha Motor sells equipment used in marina applications, such as pontoons.

### Water Purifiers



Yamaha Motor manufactures and markets water purifiers to improve the quality of living in Southeast Asia and other regions where access to potable water is limited.

### Racing Kart Engines



Yamaha Motor manufactures and sells engines for racing karts, entry-level machines often used to gain access to more challenging four-wheel motor sports.



Japanese: [www.yamaha-motor.co.jp/](http://www.yamaha-motor.co.jp/)  
English: [www.yamaha-motor.co.jp/global/](http://www.yamaha-motor.co.jp/global/)

